

Key among the principles of the Framework Plan were recommendations that the campus be formally organized into five precincts: Arts, Inner Campus, Professional, Stadium, and Wheeler.

* Approved by Board of Regents. May 2006

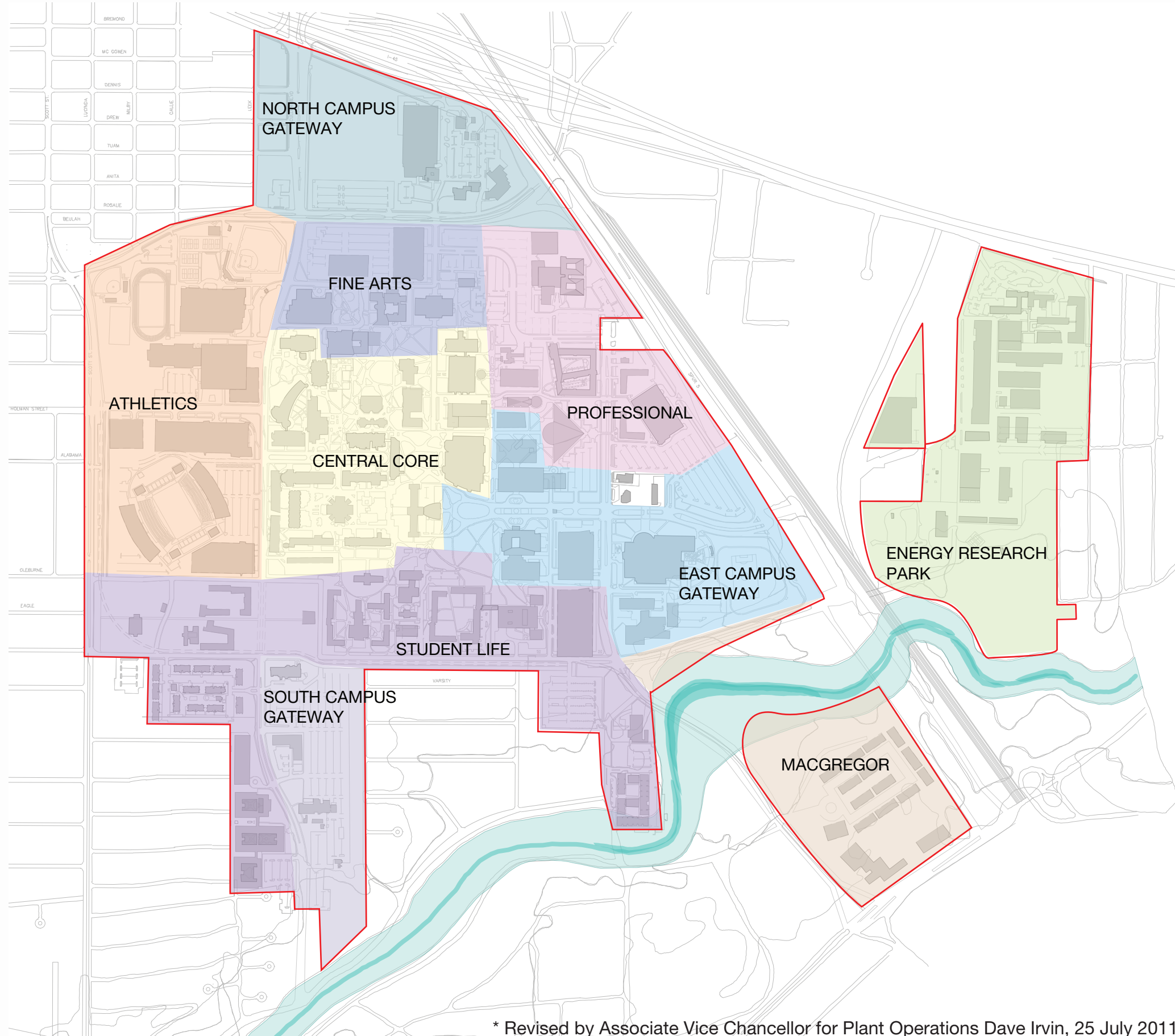

As a component of preliminary master planning work in 2011, the five Framework precincts were expanded to include recently acquired properties and other parcels on the campus perimeter not included in the original precincts. Ten campus precincts were identified in a working master plan document dated 25 July 2011: Athletic, Central Core, East Campus Gateway, Energy Research Park, Fine Arts, MacGregor, North Campus Gateway, Professional, South Campus Gateway, and Student Life.

* Revised by Associate Vice Chancellor for Plant Operations Dave Irvin, 25 July 2011

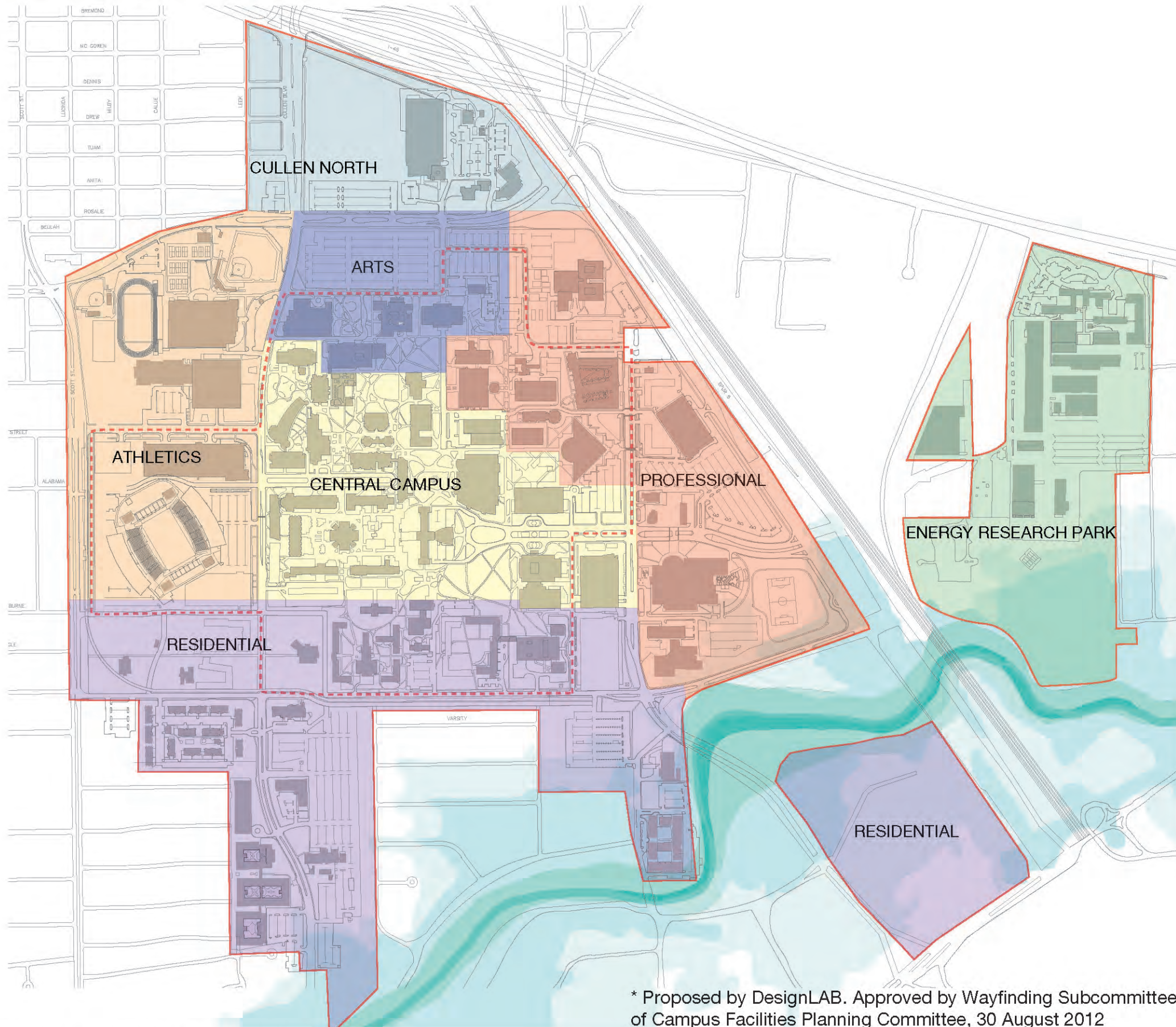

The UH Arts Master Plan and related Wayfinding Master Plan in 2012 realigned and renamed these campus districts to yield seven zones that promote a more unified identity and memorable character within each: Arts, Athletics, Central Campus, Cullen North, Energy Research Park, Professional, Residential. These will be reinforced through wayfinding and subsequent campus planning efforts.

* Proposed by DesignLAB. Approved by Wayfinding Subcommittee of Campus Facilities Planning Committee, 30 August 2012



- Purple RESIDENTIAL
- Green ENERGY RESEARCH PARK
- Red ATHLETICS
- Teal ARTS
- Blue PROFESSIONAL
- Tan CULLEN NORTH
- Magenta BIOMEDICAL
- Yellow CENTRAL

- 18A Parking Lot #
- 1 Campus Entrance
- P Visitor Parking







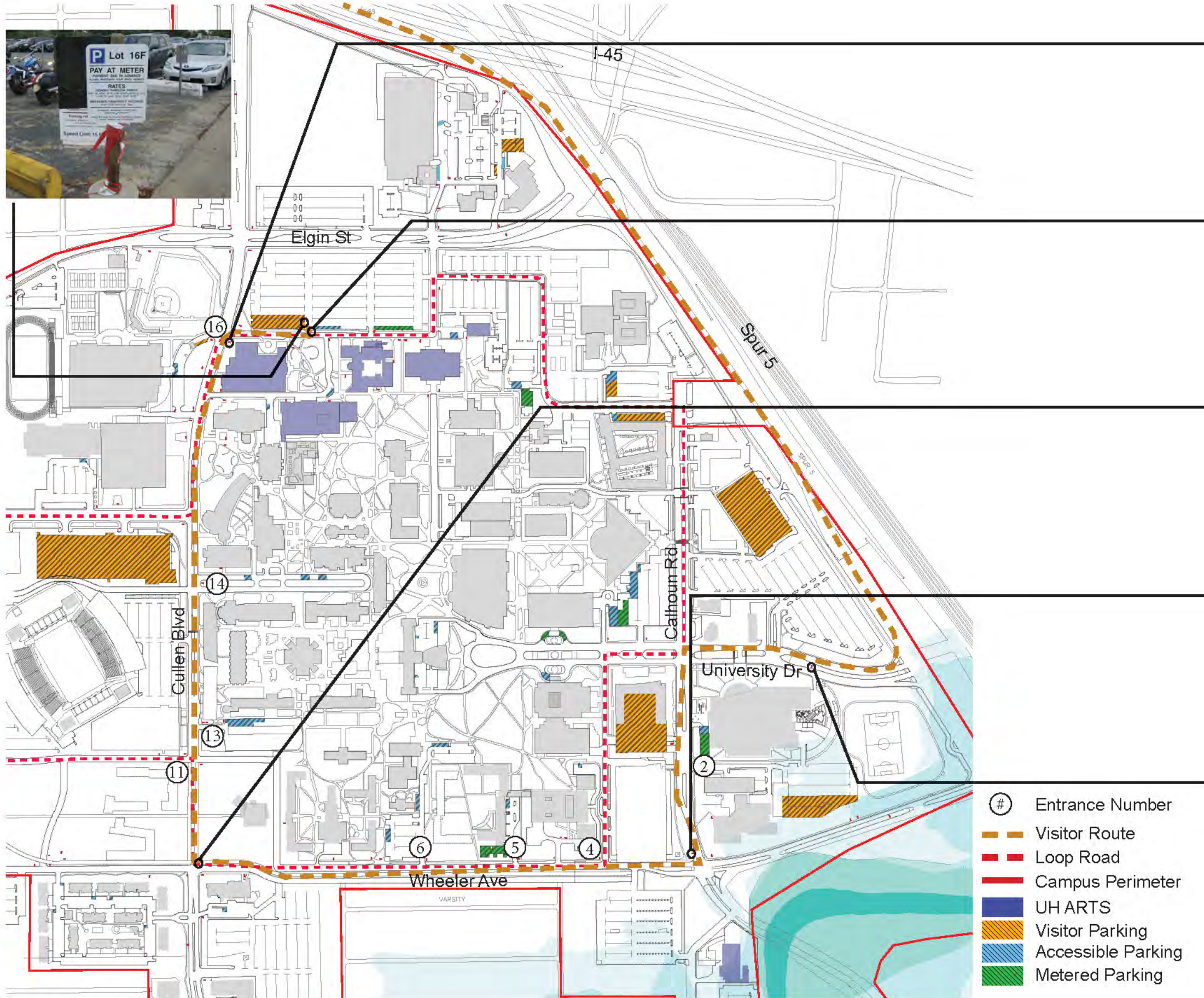

- # Entrance Number
- Visitor Route
- Loop Road
- Campus Perimeter
- UH ARTS
- Visitor Parking
- Accessible Parking
- Metered Parking



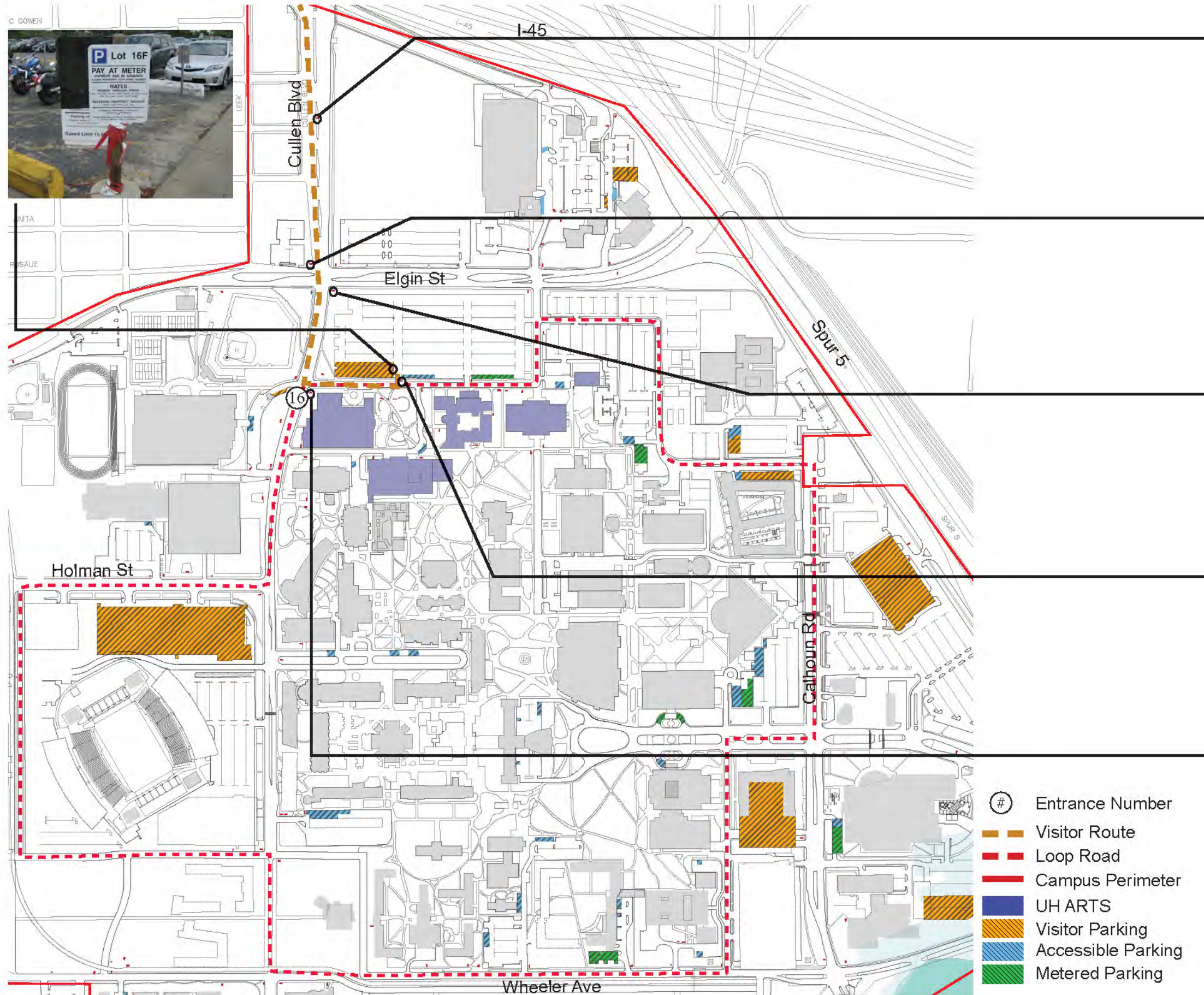

- Ⓜ Entrance Number
- Visitor Route
- - - Loop Road
- Campus Perimeter
- UH ARTS
- ▨ Visitor Parking
- ▨ Accessible Parking
- ▨ Metered Parking

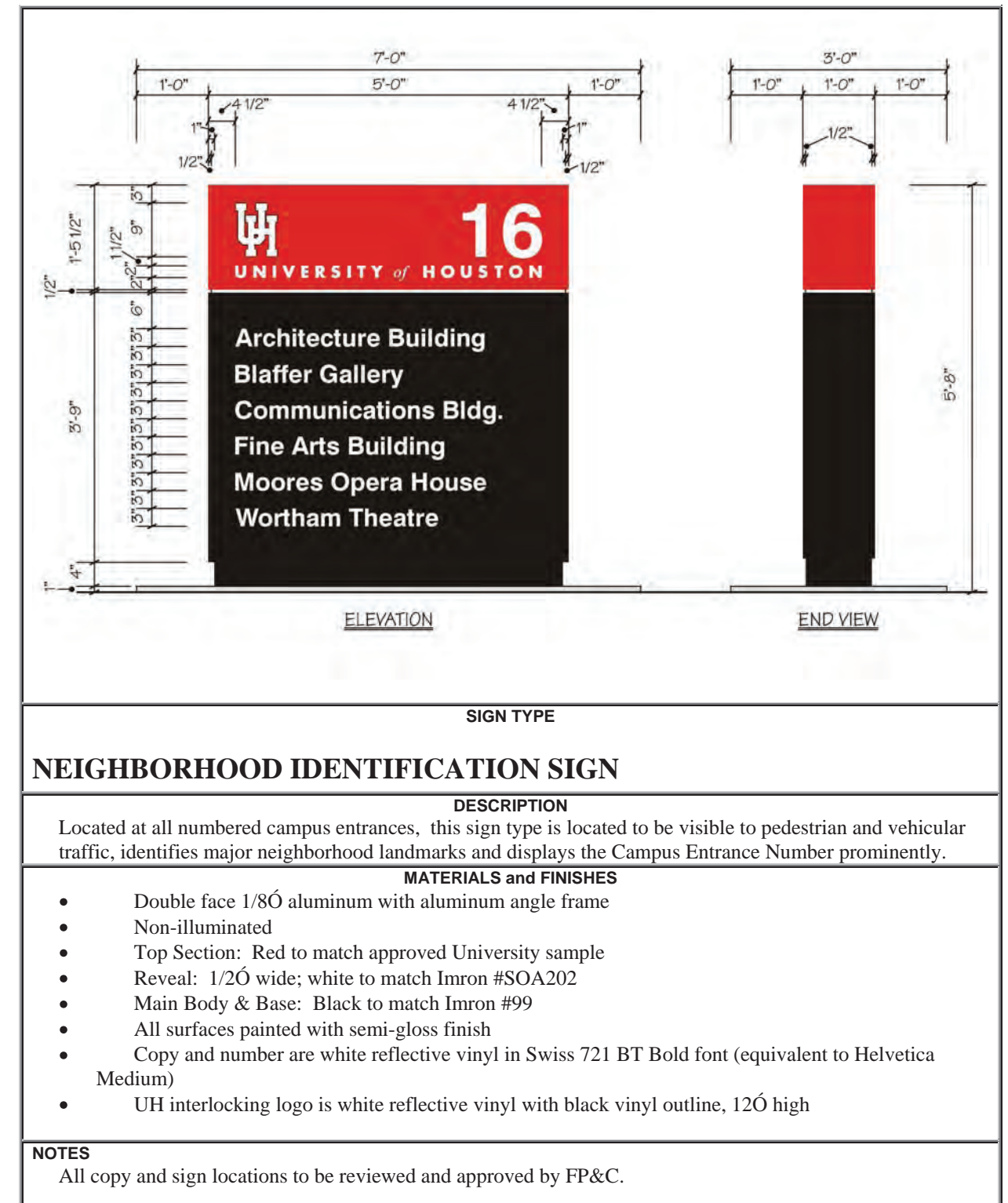
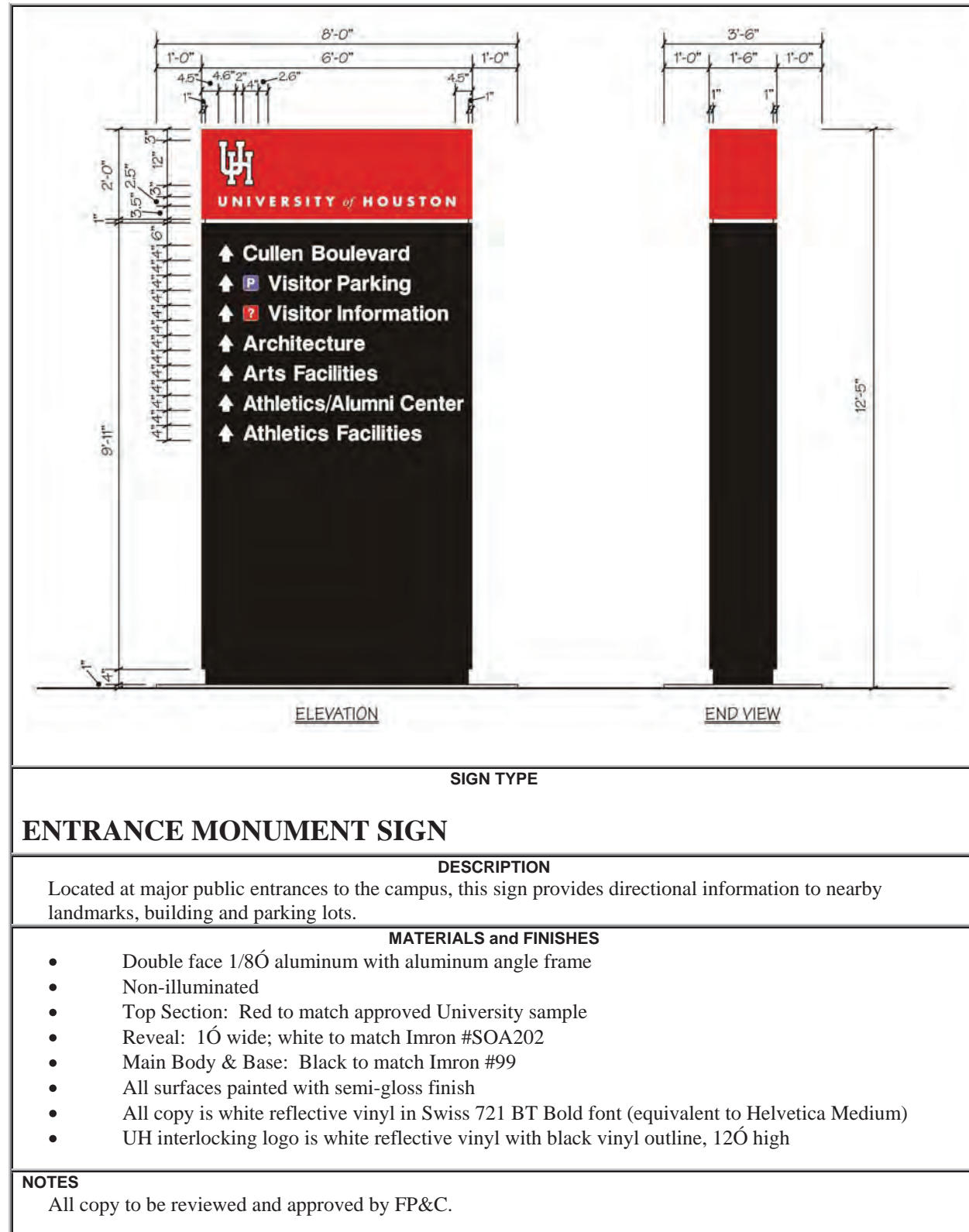

* Campus Design Guidelines and Standards Section 10 Wayfinding Standards and Guidelines

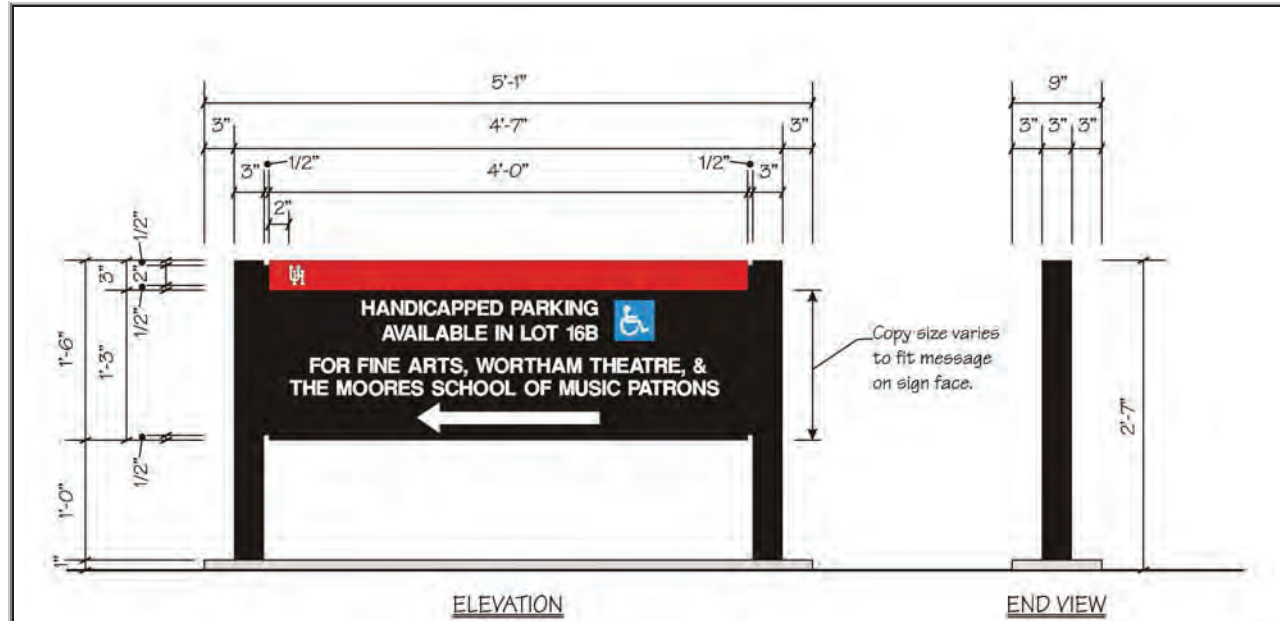

SIGN TYPE

WAYFINDING SIGN

DESCRIPTION

Located adjacent to sidewalks on the interior of campus, this sign points the direction to major buildings or landmarks.

MATERIALS and FINISHES

- Double face 1/8" aluminum with 1/8" aluminum posts
- Non-illuminated
- Top Section: Red to match approved University sample
- Vertical Reveals: 1/2" wide; black to match Imron #99
- Main Body & Posts: Black to match Imron #99
- All surfaces painted with semi-gloss finish
- Copy is white reflective vinyl in Swiss 721 BT Bold font (equivalent to Helvetica Medium)
- UH interlocking logo is white reflective vinyl with black vinyl outline, 2" high

NOTES

All copy and sign locations to be reviewed and approved by FP&C.

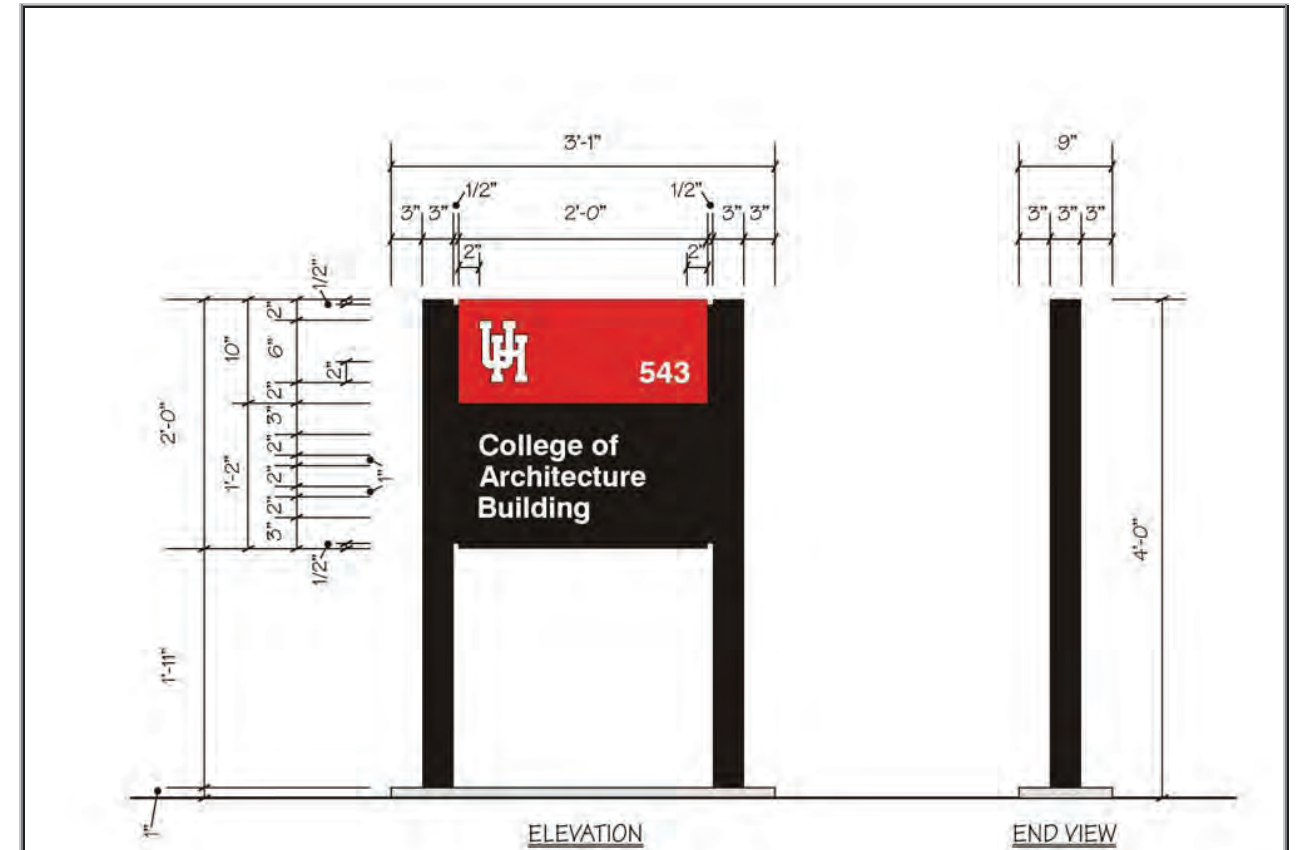

SIGN TYPE

BUILDING NAME SIGN

DESCRIPTION

Located at all building entrances, this sign displays the building name and the building number. Department names will be shown in building main entrance directories only.

MATERIALS and FINISHES

- Double face 1/8" aluminum with 1/8" aluminum posts
- Non-illuminated
- Top Section: Red to match approved University sample
- Vertical Reveals: 1/2" wide; black to match Imron #99
- Main Body & Posts: Black to match Imron #99
- All surfaces painted with semi-gloss finish
- Copy and number are white reflective vinyl in Swiss 721 BT Bold font (equivalent to Helvetica Medium)
- UH interlocking logo is white reflective vinyl with black vinyl outline, 6" high

NOTES

All copy and sign locations to be reviewed and approved by FP&C.

* Campus Design Guidelines and Standards Section 10 Wayfinding Standards and Guidelines

Option 1

Direct Replacement
Fabrication and Installation \$ 7,750*

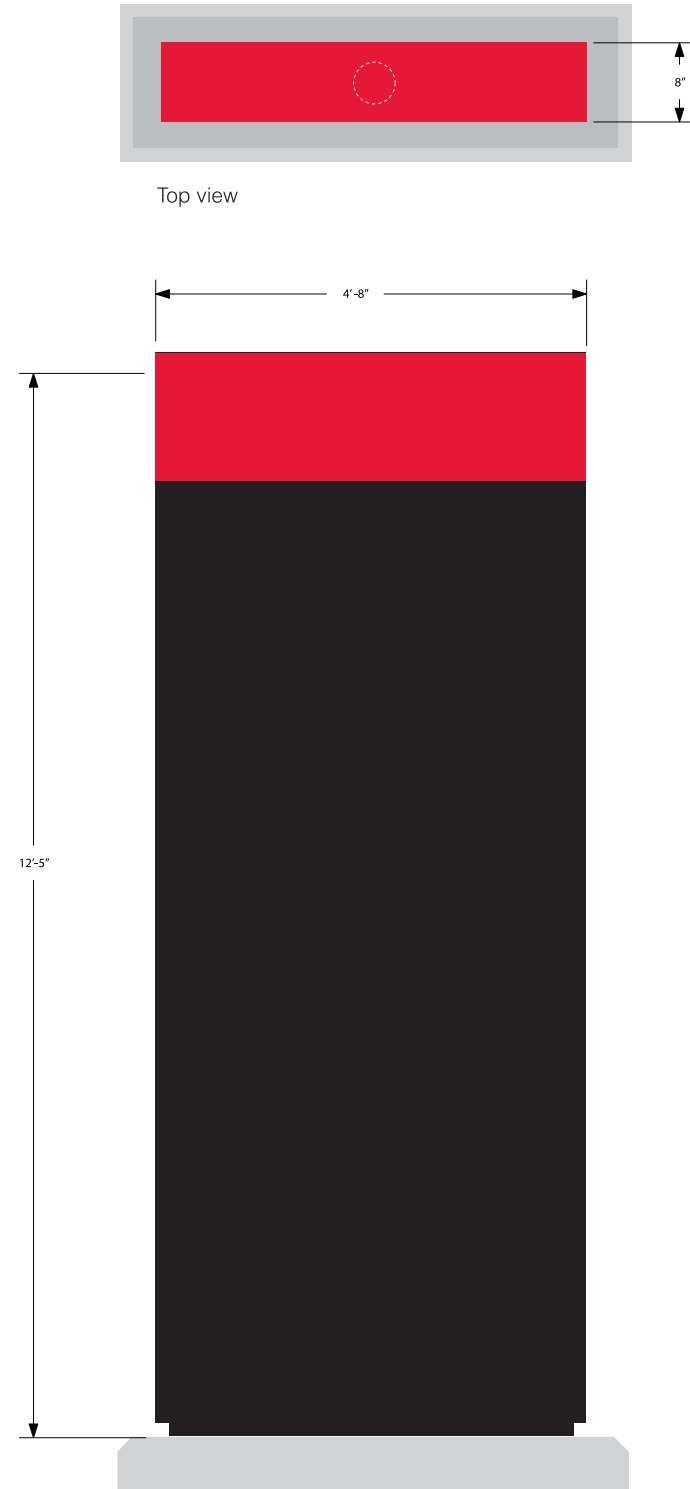
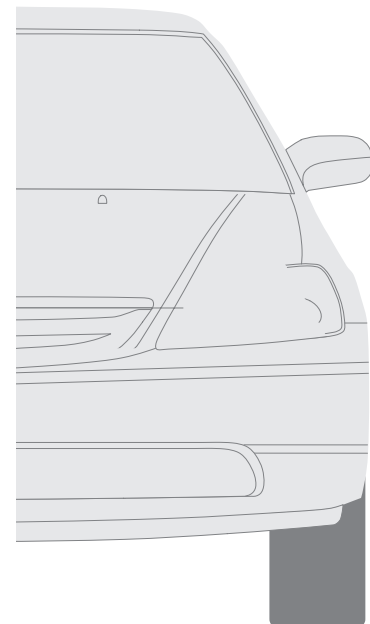

Sign destroyed and to be replaced



Remaining footing and internal support 7.12

NOTE: Dimensions are approximate. Final sign will replicate previous version.

PRODUCTION NOTES
1. All surfaces to be specified per existing system

Option 2

Fabrication and Installation \$ 8,800*

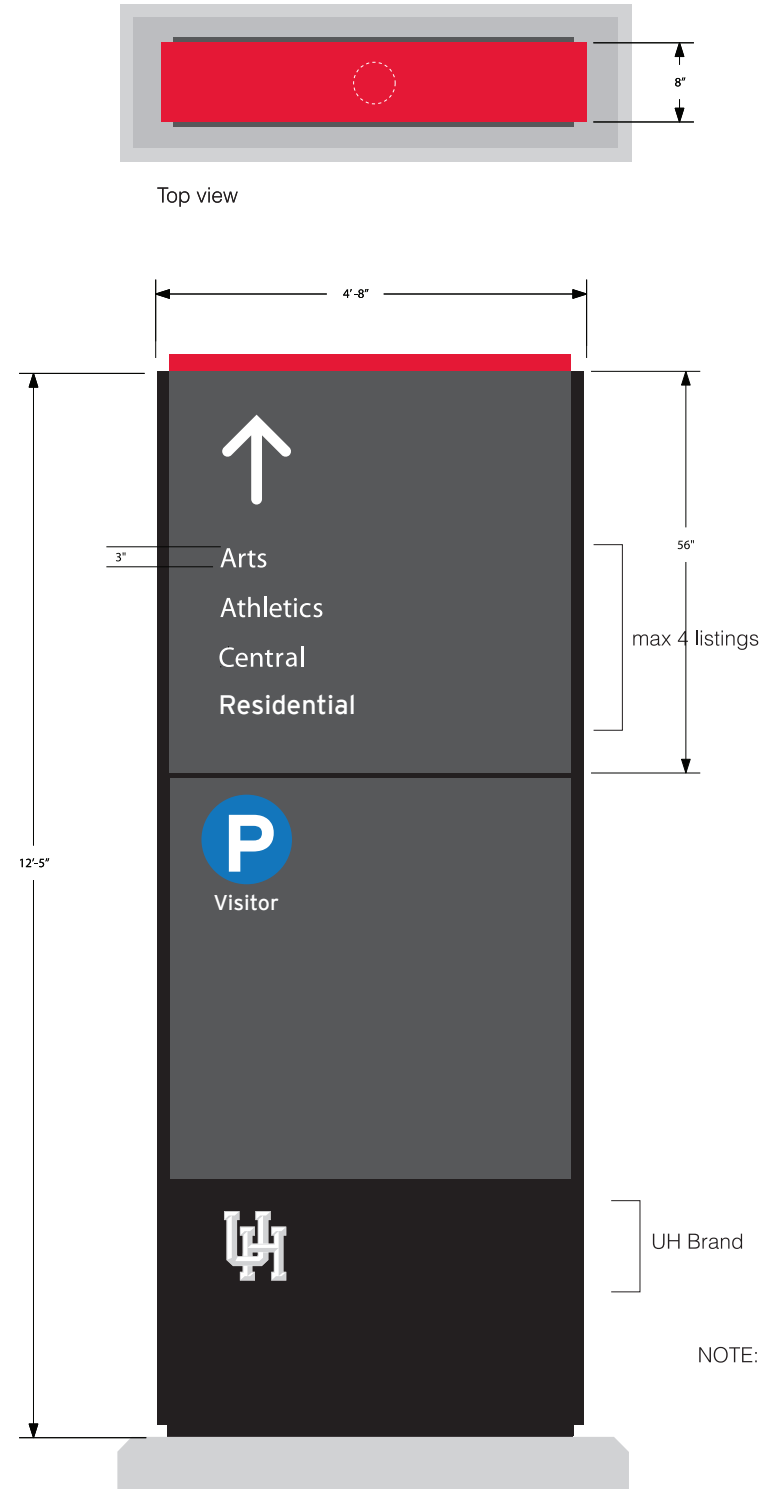
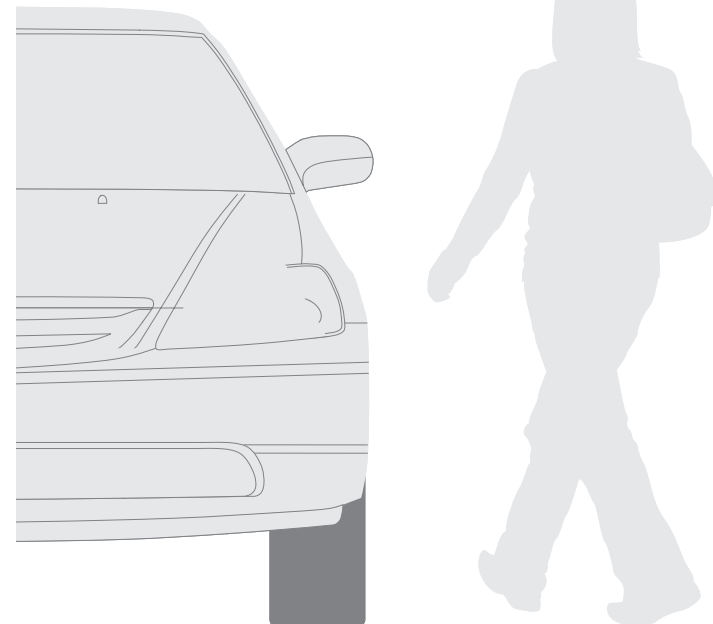

Sign destroyed and to be replaced



Remaining footing and internal support 7.12

NOTE: Dimensions are approximate. Final sign will replicate previous version.

PRODUCTION NOTES

1. All surfaces to be specified per existing site, porcelain enamel, enameled text and graphics or screen printed text and graphics. (emphasis is long term durability, color retention and wear rate).

Option 3

Fabrication and Installation \$ 8,950*

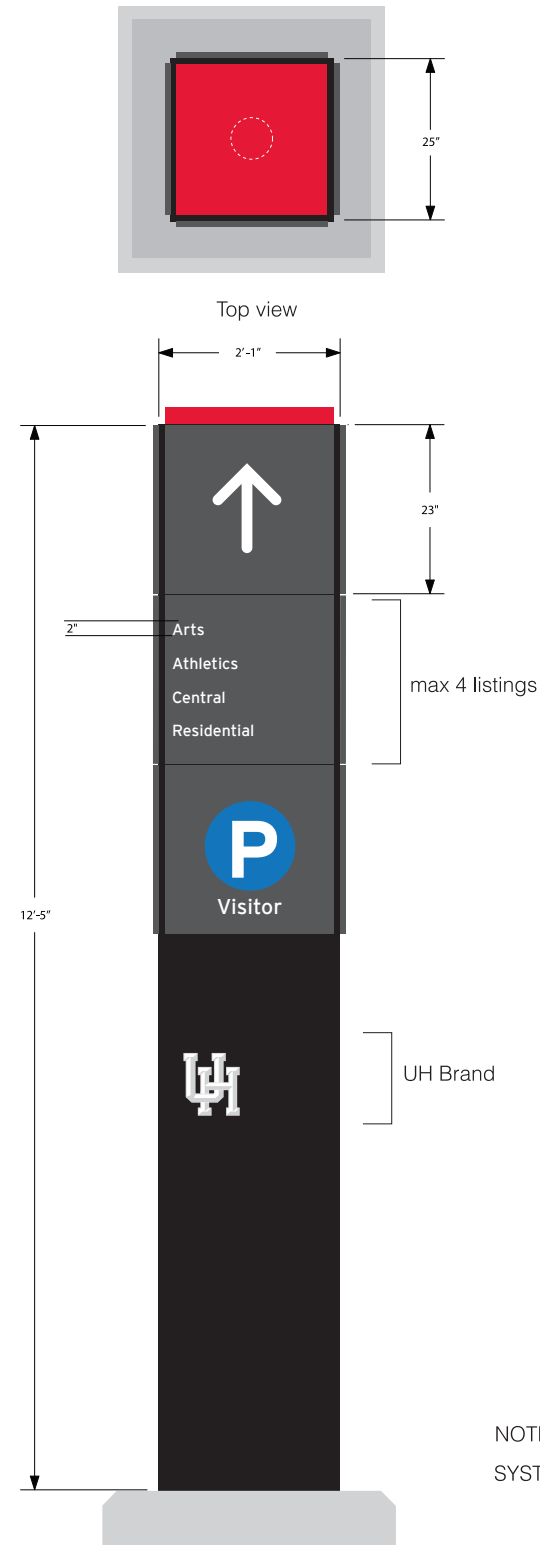
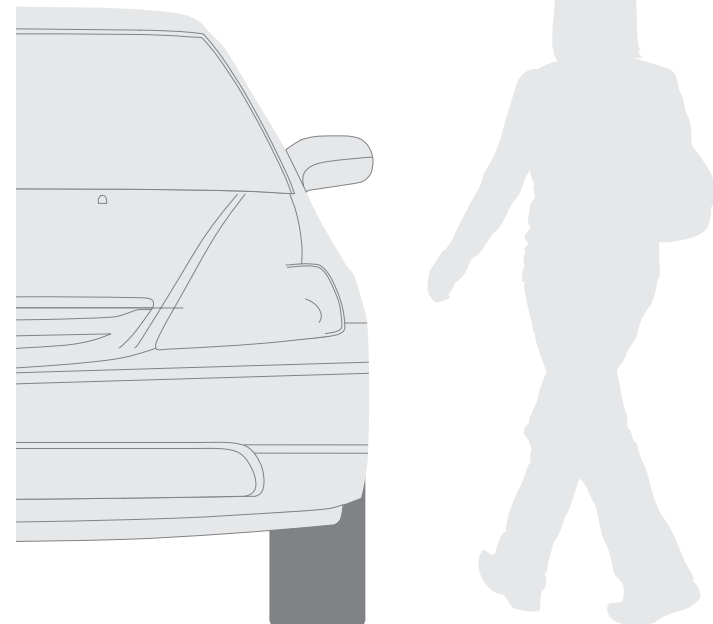

Sign destroyed and to be replaced



Remaining footing and internal support 7.12

NOTE: Sign provides 4 sides for messaging
SYSTEM FONT: Interstate

PRODUCTION NOTES

1. All surfaces to be specified powder coat, painted, porcelain enamel, enameled text and graphics or screen printed text and graphics. (emphasis is long term durability, color retention and wear rate).



Sign installed directly on existing footing. Not recommended
pros: less expensive install
cons: odd installation, not true to final intended appearance



Existing footing modified to accommodate new sign.
Replace sod and clean up site. recommended
pros: more accurate presentation of final sign appearance
cons: more expensive install

Font Family - Interstate

Vehicular - Directional

113 ft Daylight
75 ft Low light
75% reliability (% of population will read)

Vehicular - Entrances and Campus Directionals

75 ft Daylight
50 ft Low light
75% reliability (% of population will read)

Pedestrian Directional

37 ft Daylight
25 ft Low light
75% reliability (% of population will read)

Scale Test

PRODUCTION NOTES

1. All surfaces to be specified powder coat, painted, porcelain enamel, enameled text and graphics or screen printed text and graphics.
(emphasis is long term durability, color retention and wear rate).



Visitor Information
Arts Facilities
Athletics Alumni Center
Athletics Facilities
Clinical Research Center
Hilton Hotel and Conference Center
Human Resources
Student Housing
University Eye Institute

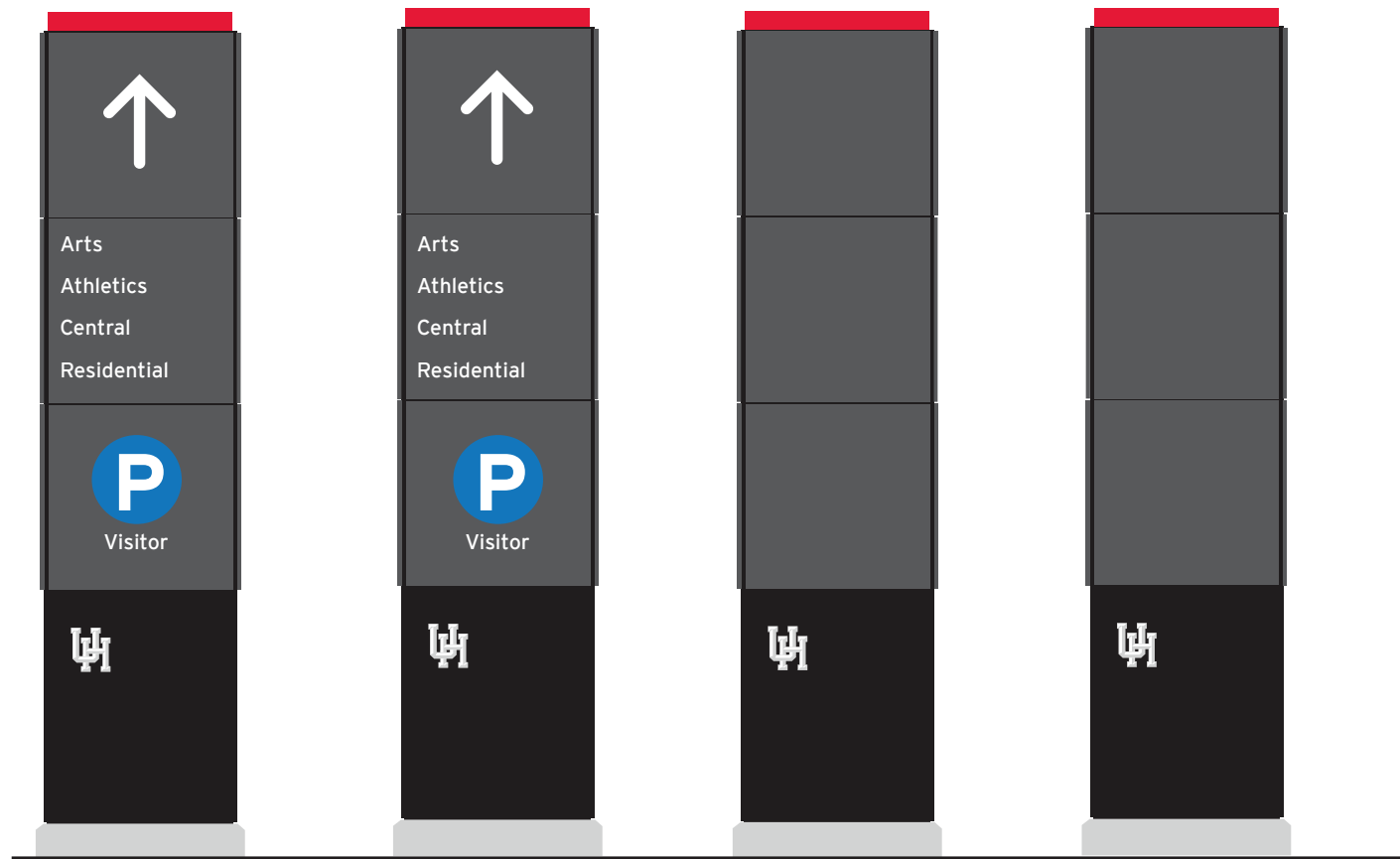

north facing

↑
Arts
Athletic Facilities
Alumni Center
Student Housing

?
Information

west facing

→
Arts
Athletic Facilities
Alumni Center
Student Housing

?
Information

south facing

east facing

Read time 2.25 sec @ 35 mph
113 ft readability or 51 ft per second
adult reads approx. 4.1 words per second

Font Family - Interstate

Vehicular - Directional

113 ft Daylight
75 ft Low light
75% reliability (% of population will read)

Scale Test

PRODUCTION NOTES

1. All surfaces to be specified powder coat, painted, porcelain enamel, enameled text and graphics or screen printed text and graphics. (emphasis is long term durability, color retention and wear rate).

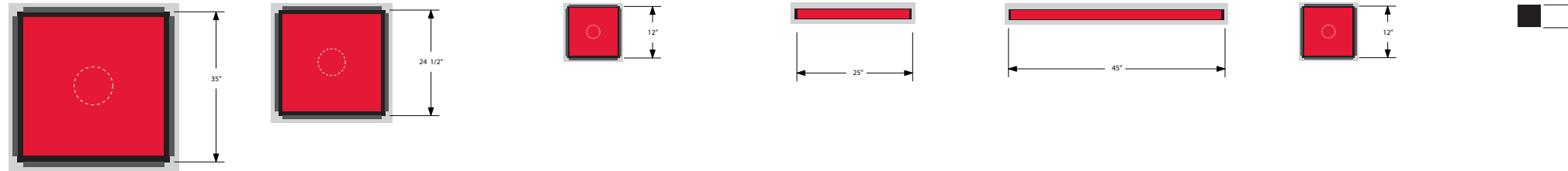

Top view

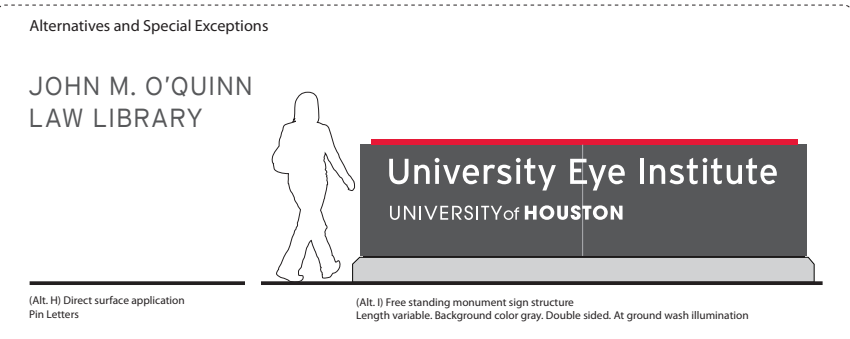
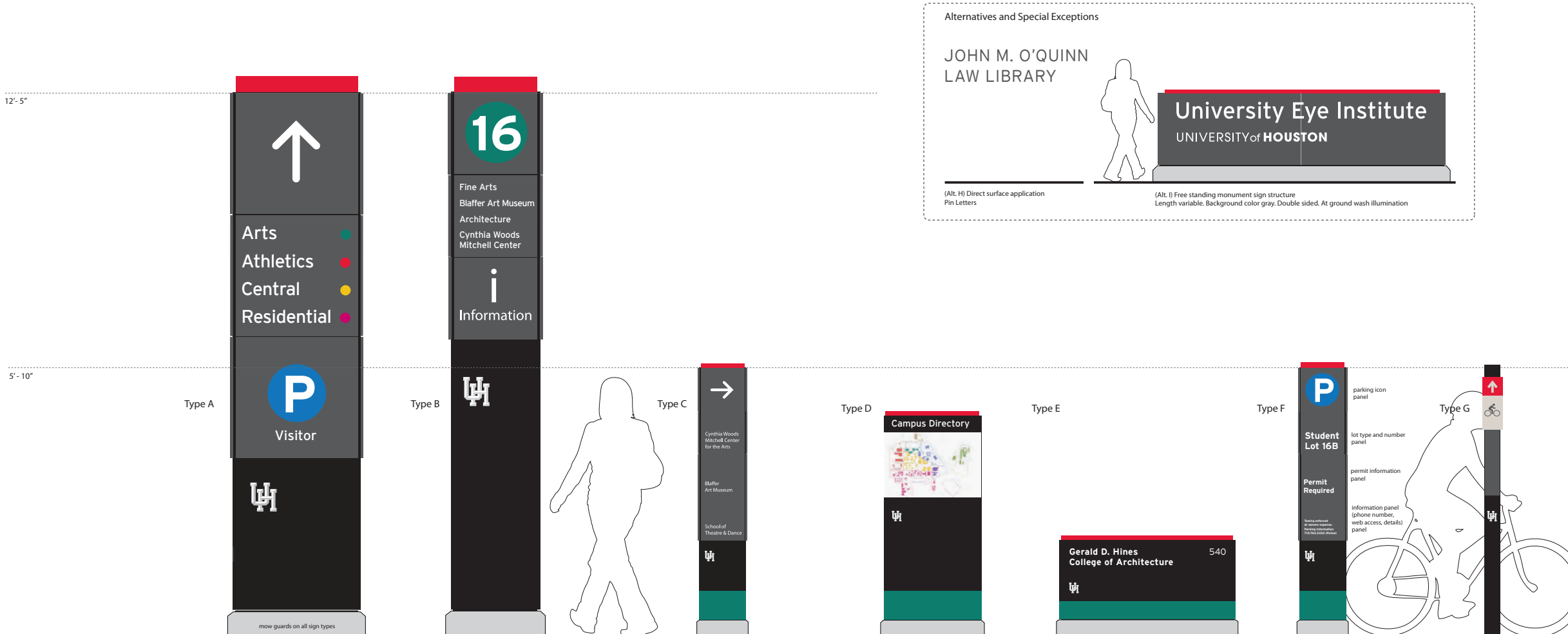

SIGN TYPE	Directional (Fast Traffic) Campus perimeter, public thoroughfares	Directional (Entrances and Campus Directionals)	Directional (Pedestrian) Campus wayfinding	Directory Kiosk (Pedestrian) Campus wayfinding	Building Identifier Campus wayfinding	Parking Identifier Parking lot entry markers	Bike Path Marker Pedestrian Path Marker
	(qty. 9)	(qty. 23)	(qty. 42)	(qty. 25)	(qty. 163)	(qty. 56)	(qty. tbd)
VISIBILITY METRICS	140 ft Daylight 92 ft Low light 75% Reliability (% of population will read)	80 ft Daylight 50 ft Low light 75% Reliability (% of population will read)	40 ft Daylight 25 ft Low light 75% Reliability (% of population will read)				
PRODUCTION FEATURES	<ul style="list-style-type: none"> > 4 active message sides > Porcelain enamel faces and trim > Screen printed graphics > Painted and UV coated frame structure > Graffiti-proof surfaces > Changeable face panels for updating > Attachments, tamper proof hardware > Footing includes mow guard and peer construction for stability > Font family - Interstate 	<ul style="list-style-type: none"> > 4 active message sides > Porcelain enamel faces and trim > Screen printed graphics > Painted and UV coated frame structure > Graffiti-proof surfaces > Changeable face panels for updating > Attachments, tamper proof hardware > Footing includes mow guard and peer construction for stability > Font family - Interstate 	<ul style="list-style-type: none"> > 4 active message sides > Porcelain enamel faces and trim > Screen printed graphics > Painted and UV coated frame structure > Graffiti-proof surfaces > Changeable face panels for updating > Attachments, tamper proof hardware > Footing includes mow guard and peer construction for stability > Font family - Interstate 	<ul style="list-style-type: none"> > 2 active message sides > Porcelain enamel trim > Digital printed map (flexible updating) > Painted and UV coated frame structure > Graffiti-proof surfaces > Attachments, tamper proof hardware > Footing includes mow guard and peer construction for stability > Font family - Interstate 	<ul style="list-style-type: none"> > 2 active message sides > Porcelain enamel trim > Screen printed graphics and text > Painted and UV coated frame structure > Graffiti-proof surfaces > Attachments, tamper proof hardware > Footing includes mow guard and peer construction for stability > Font family - Interstate 	<ul style="list-style-type: none"> > 4 active message sides > Porcelain enamel faces and trim > Screen printed graphics > Painted and UV coated frame structure > Graffiti-proof surfaces > Changeable face panels for updating > Attachments, tamper proof hardware > Footing includes mow guard and peer construction for stability > Font family - Interstate 	

UH Wayfinding Color System - PROPOSED
Pantone colors are matched from the Matte Swatch Book

PMS 220		Magenta RESIDENTIAL
PMS 7496		Green ENERGY RESEARCH PARK
PMS 186		Red ATHLETICS
PMS 562		Teal ARTS
PMS 660		Blue PROFESSIONAL
PMS 7503		Tan CULLEN NORTH
PMS 2603		Purple BIOMEDICAL
PMS 7406		Yellow CENTRAL

University of Houston
Houston Texas

DRAWN: SR
CHECKED: CM
SCALE: As noted
DATE: 26 February 2013
MD PROJECT NO: xxx-001

Color Palette

Sheet No. 10

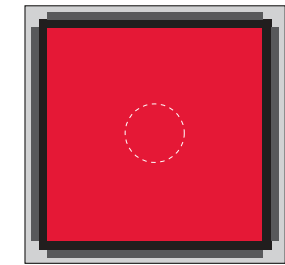

Top view

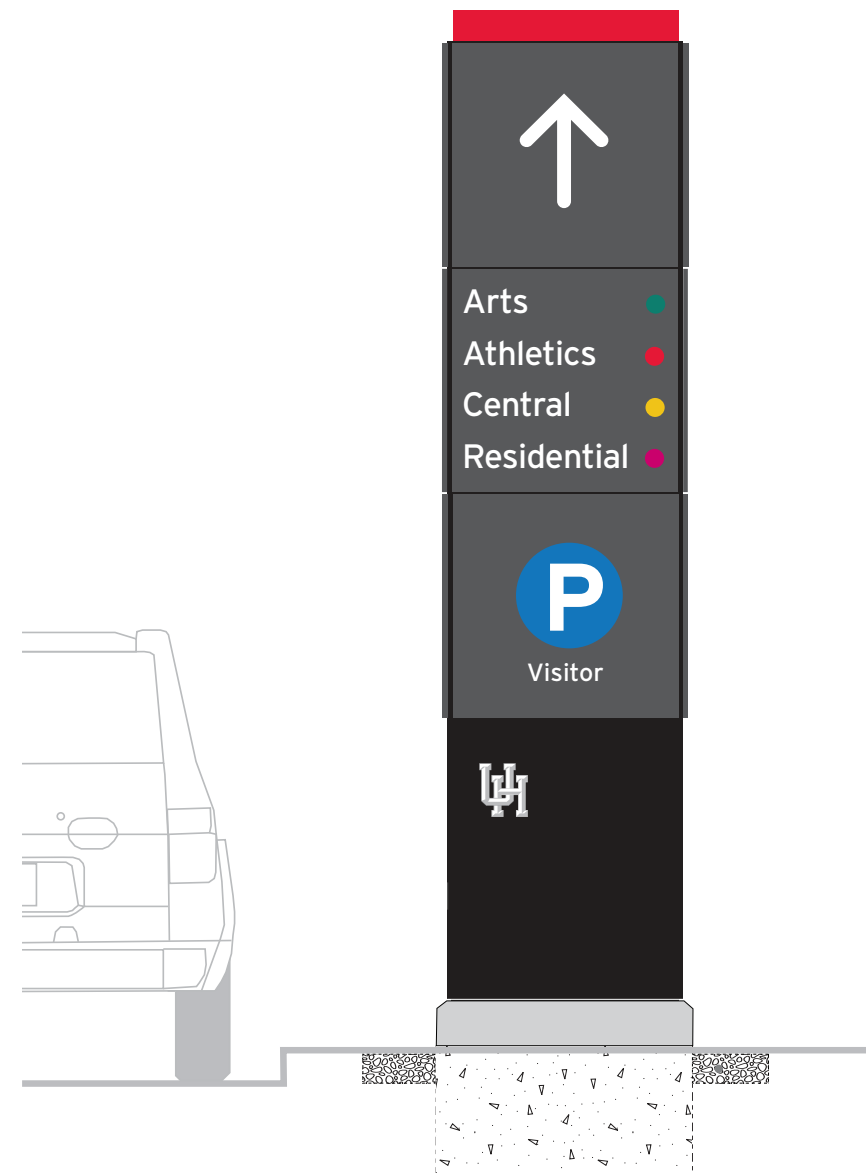

1 SIGN TYPE A - Auto Directional | Primary
Scale: 1/2"=1'-0"

© Minor Design 2013

University of Houston
Houston Texas

DRAWN: SR
CHECKED: CM
SCALE: As noted
DATE: 16 January 2013
MD PROJECT NO: xxx-001

Sign Type A
Comparison

Sheet
No. 10

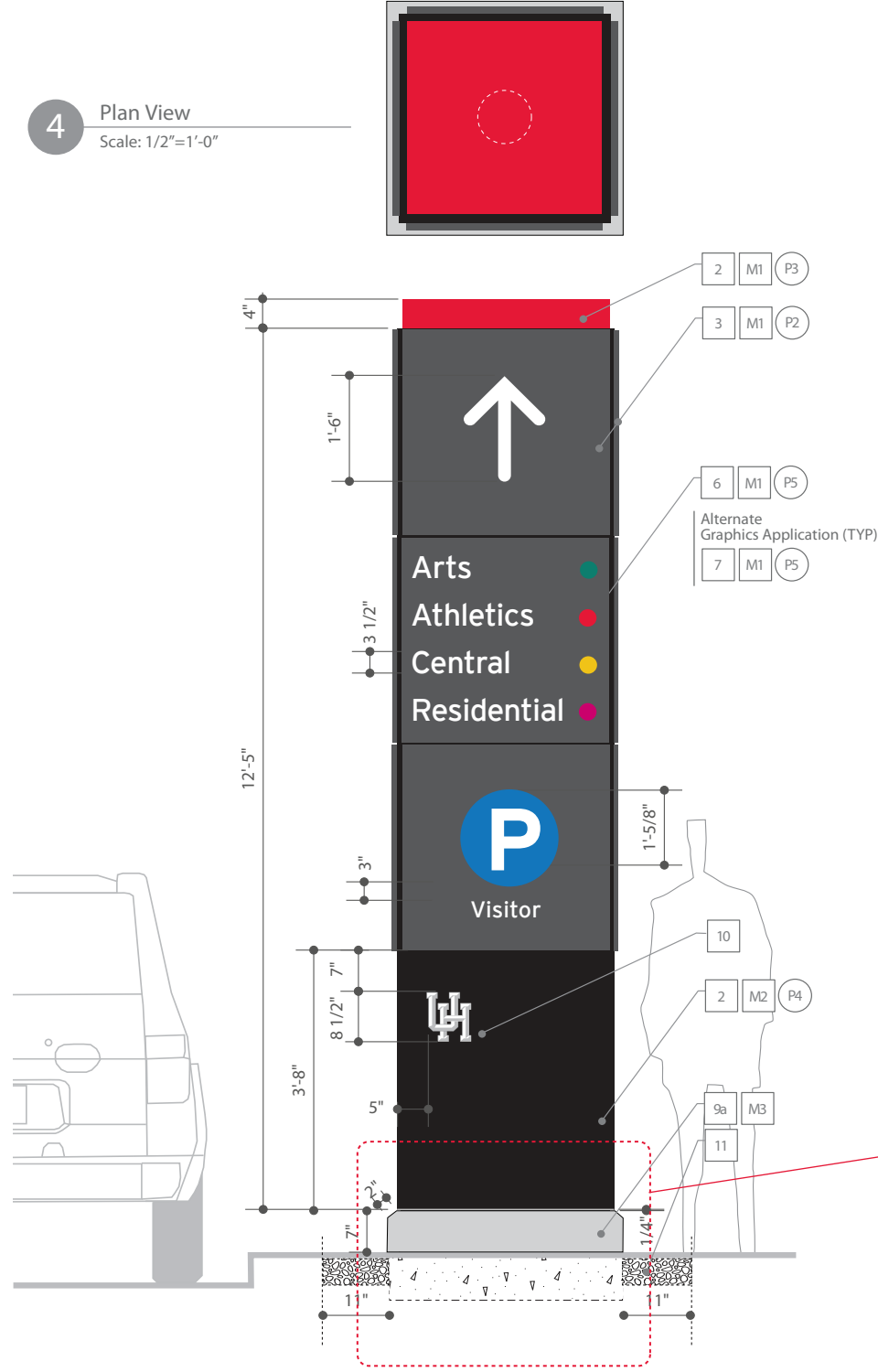

1 SIGN TYPE A - Auto Directional | Primary
Scale: 1/2"=1'-0"

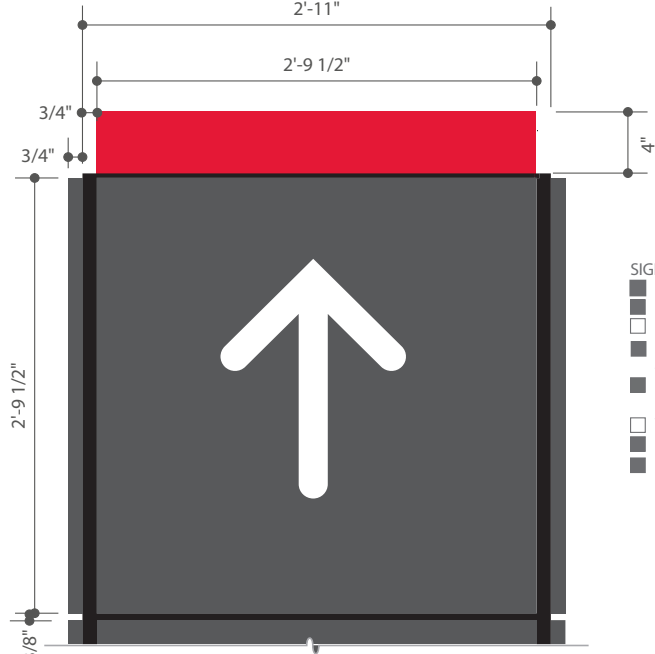

2 DETAIL - Panel
Scale: 1"=1'-0"

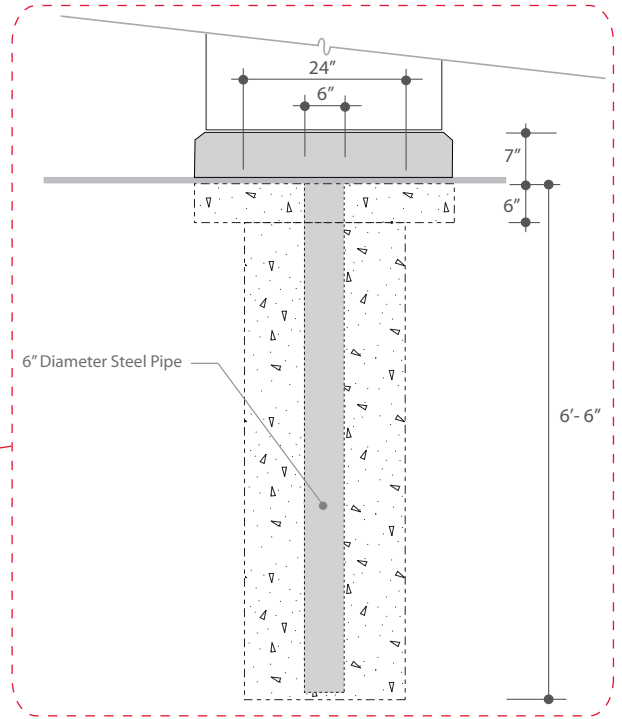

5 DETAIL - Footing
Scale: 1"=1'-0"

- MINOR DESIGN TO PROVIDE:
- Digital files for all artwork (Adobe Illustrator CS4/14.0)
 - Camera ready art (Full Size, Each Sign Panel Face)
 - Rendering
 - Color swatches to match
 - Finish samples
 - Material samples
 - Color comp

- SIGN CONTRACTOR TO PROVIDE:
- Shop Drawings
 - Engineering Calculations
 - Material samples, 4"x6" (QTY: 2)
 - Paint and Porcelain samples on 1/8" aluminum/steel, 4"x6" (QTY: 3)
 - Layout Patterns
 - Copy □ Neon ■ Mechanical Fasteners
 - V.D.C. Sample line of copy as noted
 - Local Sign Permits
 - Fabrication Sample
 - 12"x 25" sample of the HPL panel, art two sides
 - Complete sign
 - As specified on drawing
 - In production review
 - On-Site
 - Fabricator to verify field conditions
 - or to fabrication

1. Non-internally illuminate pylon with surface applied message panels.
- 1a. Sign Contractor responsible for determining internal structure for support and mounting to concrete base and footing.
2. 0.90" thick aluminum base pylon and 'cap', cap to be porcelain enamel. Base painted to match indicatd color, painted surfaces to be clear coated, satin finish.
3. 3/4" deep, 0.90" thick surface mounted removable reverse pan panels, porcelain enamel, face and returns, satin finish.
- 3a. Mounting holes are to be drilled on panel edges prior to porcelain enamel application.
4. Surface mounted aluminum angles for mounting of panels.
- 4a. Mount panels to angles with countersunk mechanical fasteners, painted to match adjacent surface color.
5. Isolate dissimilar metals.
6. Graphics Option 1: Integral graphics in porcelain enamel.
7. Graphics Option 2: Surface screened graphics on porcelain enamel.
8. Internal structure to be secured to concrete footing with appropriate mechanical fasteners/anchors as determined by Sign Contractor.
9. Sign Contractor to determine and provide concrete foundation/footing to withstand 110 mph windloads and local weather conditions.
- 9a. Sign Contractor to provide 1/2" wide, 45° bevel on all exposed footing edges.
10. Screen printed graphic
11. Mowstrip specifications TBD.

NOTE:
Options are to be priced as separate line items.

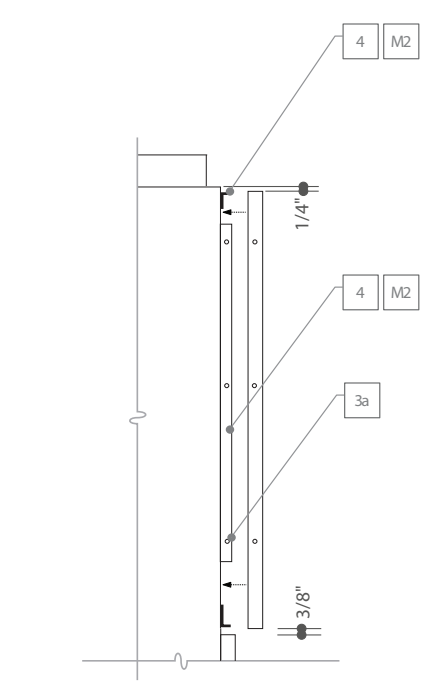

3 SECTION
Scale: 1"=1'-0"

© Minor Design 2013
All drawings and written material appearing herein constitute original and unpublished work of Minor Design and may not be used or disclosed without prior written consent of Minor Design.

DRAWING FOR CONSTRUCTION INTENT ONLY.
NOT INTENDED FOR CONSTRUCTION.
NOTE: ITEMS ARE AT SCALE NOTED WHEN THIS SHEET IS PRINTED AS AN 11" X 17" SHEET.

University of Houston
Houston Texas

DRAWN: SR
CHECKED: CM
SCALE: As noted
DATE: 26 February 2013
MD PROJECT NO: xxx-001

Sign Type A
Auto Directional
Primary - Fast Traffic

Sheet No. **09**

4 Plan View
Scale: 1/2"=1'-0"

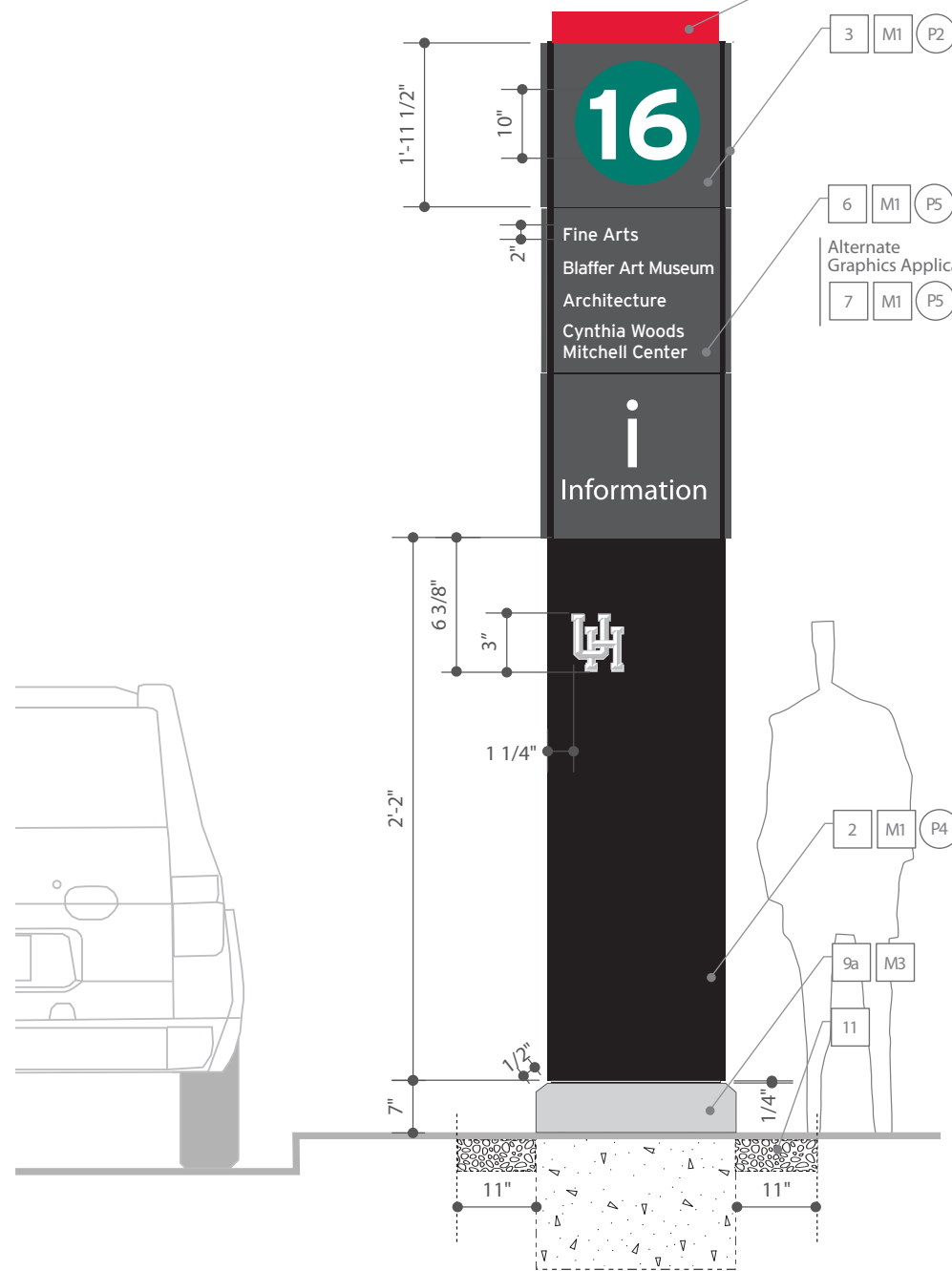
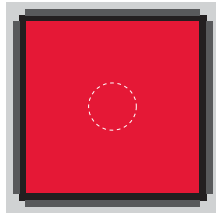

1 SIGN TYPE B - Auto Directional | Secondary
Scale: 1/2"=1'-0"

- SIGN CONTRACTOR TO PROVIDE:
- Shop Drawings
 - Engineering Calculations
 - Material samples, 4"x6" (QTY: 2)
Stainless Steel, non-directional brush finish
 - Powder coat samples on 1/8" aluminum, 4"x6" (QTY: 2)
 - Layout Patterns
 - Copy □ Neon □ Mechanical Fasteners
 - V.D.C. Sample line of copy as noted
 - Local Sign Permits
 - Fabrication Sample
 - 12"x 25" sample of the HPL panel, art two sides
 - Complete sign
 - As specified on drawing
 - In production review
 - On-Site
 - Fabricator to verify field conditions
 - Prior to fabrication
 - Prior to installation

- MINOR DESIGN TO PROVIDE:
- Digital files for all artwork (Adobe Illustrator CS4/14.0)
 - Camera ready art (Full Size, Each Sign Panel Face)
 - Rendering
 - Color swatches to match
 - Finish samples
 - Material samples
 - Color comp

1. Non-internally illuminate pylon with surface applied message panels.
- 1a. Sign Contractor responsible for determining internal structure for support and mounting to concrete base and footing.
2. 0.90" thick aluminum base pylon and 'cap', porcelain enamel, satin finish.
3. 3/4" deep, 0.90" thick surface mounted removable reverse pan panels, porcelain enamel, face and returns, satin finish.
- 3a. Mounting holes are to be drilled on panel edges prior to porcelain enamel application.
4. Surface mounted aluminum angles for mounting of panels.
- 4a. Mount panels to angles with countersunk mechanical fasteners, painted to match adjacent surface color.
5. Isolate dissimilar metals.
6. Graphics Option 1: Integral graphics in porcelain enamel.
7. Graphics Option 2: Surface screened graphics on porcelain enamel.
8. Internal structure to be secured to concrete footing with appropriate mechanical fasteners/anchors as determined by Sign Contractor.
9. Sign Contractor to determine and provide concrete foundation/footing to withstand 110 mph windloads and local weather conditions.
- 9a. Sign Contractor to provide 1/2" wide, 45° bevel on all exposed footing edges.
10. One in-shop, full size sample to be selected, reviewed and approved by Minor Design prior to fabrication of additional signs.
- 10a. Upon sample approval, sample will be used in final program installation.
11. Mowstrip specifications TBD.

NOTE:
Options are to be priced as separate line items.

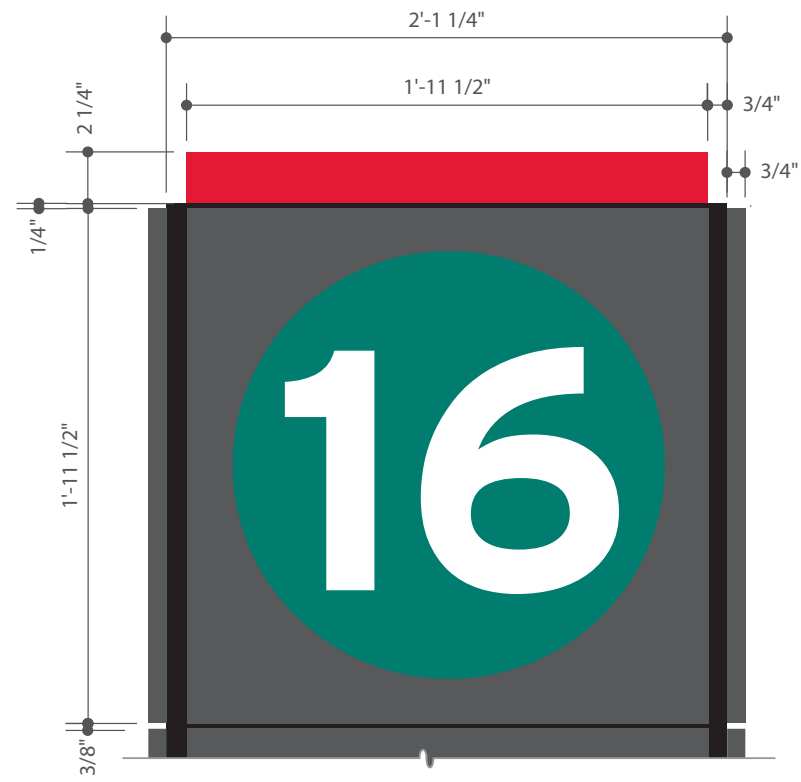

2 DETAIL - Panel
Scale: 1 1/2"=1'-0"

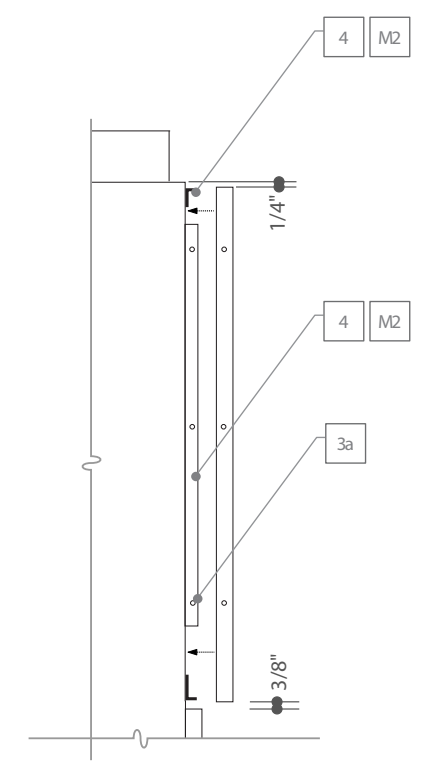

3 SECTION
Scale: 1 1/2"=1'-0"

ISSUE	DATE
100% DD	02.09.13



DRAWN: MDG
CHECKED: CM
SCALE: As noted
DATE: 09 September 2012
MD PROJECT NO: xxx-xxx

Sign Type B
Auto Directional
Secondary

Sheet No.

08

4 Plan View
Scale: 1/2"=1'-0"

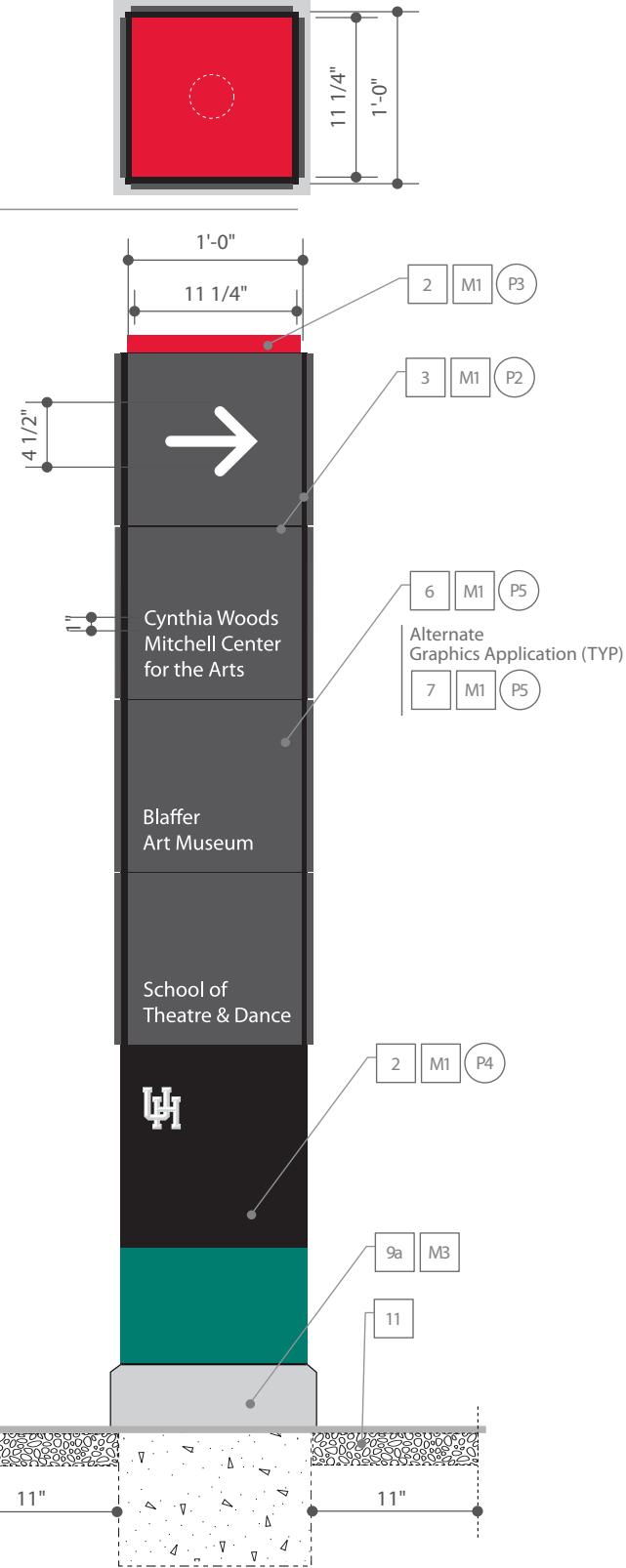

- SIGN CONTRACTOR TO PROVIDE:**
- Shop Drawings
 - Engineering Calculations
 - Material samples, 4"x6" (QTY: 2)
 - Stainless Steel, non-directional brush finish
 - Powder coat samples on 1/8" aluminum, 4"x6" (QTY: 2)
 - Layout Patterns
 - Copy
 - Neon
 - Mechanical Fasteners
 - V.D.C. Sample line of copy as noted
 - Local Sign Permits
 - Fabrication Sample
 - 12"x 25" sample of the HPL panel, art two sides
 - Complete sign
 - As specified on drawing
 - In production review
 - On-Site
 - Fabricator to verify field conditions
 - Prior to fabrication
 - Prior to installation

- MINOR DESIGN TO PROVIDE:**
- Digital files for all artwork (Adobe Illustrator CS4/14.0)
 - Camera ready art (Full Size, Each Sign Panel Face)
 - Rendering
 - Color swatches to match
 - Finish samples
 - Material samples
 - Color comp

1. Non-internally illuminate pylon with surface applied message panels.
- 1a. Sign Contractor responsible for determining internal structure for support and mounting to concrete base and footing.
2. 0.90" thick aluminum base pylon and 'cap', porcelain enamel, satin finish.
3. 3/4" deep, 0.90" thick surface mounted removable reverse pan panels, porcelain enamel, face and returns, satin finish.
- 3a. Mounting holes are to be drilled on panel edges prior to porcelain enamel application.
4. Surface mounted aluminum angles for mounting of panels.
- 4a. Mount panels to angles with countersunk mechanical fasteners, painted to match adjacent surface color.
5. Isolate dissimilar metals.
6. Graphics Option 1: Integral graphics in porcelain enamel.
7. Graphics Option 2: Surface screened graphics on porcelain enamel.
8. Internal structure to be secured to concrete footing with appropriate mechanical fasteners/anchors as determined by Sign Contractor.
9. Sign Contractor to determine and provide concrete foundation/footing to withstand 110 mph windloads and local weather conditions.
- 9a. Sign Contractor to provide 1/2" wide, 45° bevel on all exposed footing edges.
10. One in-shop, full size sample to be selected, reviewed and approved by Minor Design prior to fabrication of additional signs.
- 10a. Upon sample approval, sample will be used in final program installation.
11. Mowstrip specifications TBD.

NOTE:
Options are to be priced as separate line items.

2 DETAIL - Panel
Scale: 3"=1'-0"

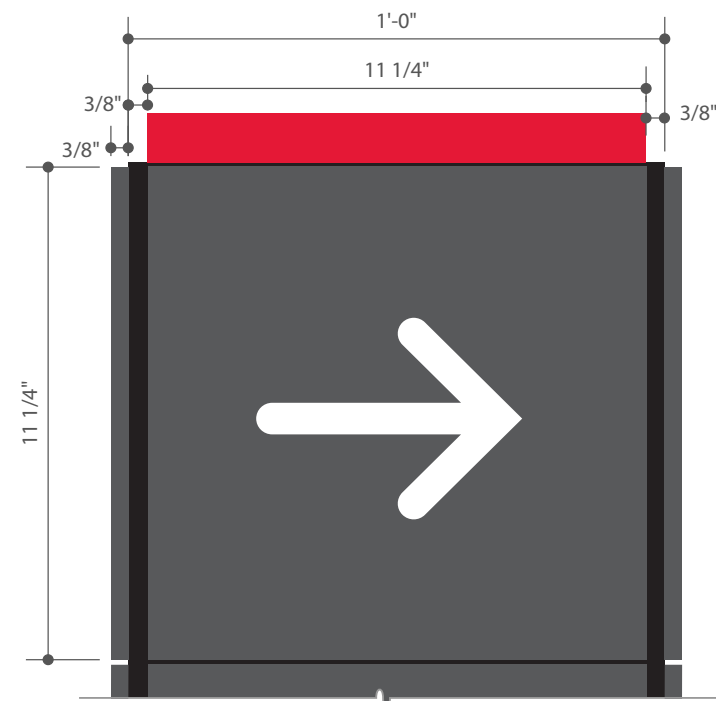

3 SECTION
Scale: 1 1/2"=1'-0"

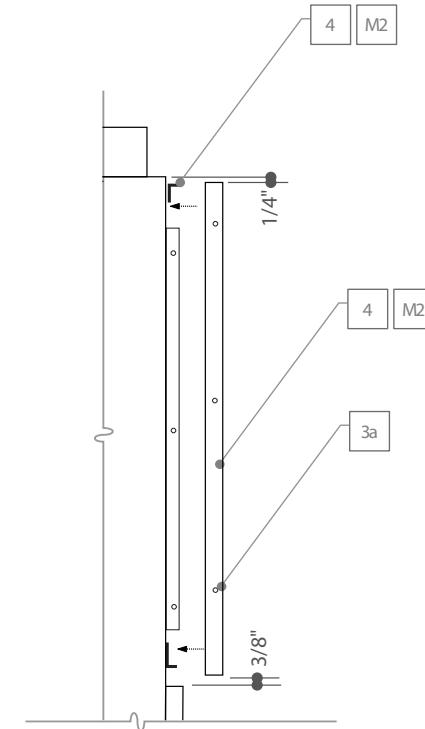

ISSUE	DATE
100% DD	02.09.13