

SECTION 0.0

PREFACE

What is architecture anyway? Is it the vast collection of the various buildings which have been built to please the varying taste of the various lords of mankind? I think not. No, I know that architecture is life: or at least it is life itself taking form and therefore, it is the truest record of life as it was lived in the world yesterday, as it is lived today, or ever will be lived. So architecture I know to be a great spirit. It can never be something which consists of the buildings which have been built by man on earth--mostly now rubbish heaps or soon to be. Architecture is that great living spirit which, from generation to generation, from age to age, proceeds, persists, creates, according to the nature of man and his circumstances. That is really architecture.

Frank Lloyd Wright
The London Lectures, 1939

There are few more clear examples of architecture as a "great living spirit" than the college or university. The architecture and the campus of academia are certainly among the "truest record[s] of life", and over time they become a powerful and tangible symbol of its "great living spirit".

The University of Houston is now eighty-nine years old. In that period of time it has become a strong living spirit within the spirited city whose name it bears. In that period of time the University has recorded its life in more than a hundred buildings on a wooded campus of more than 700 acres. Through the better part of a century the institution and its architects have done a good job of recording its life in a coherent, pleasant, and useful form that is fundamentally in accord with its original campus plan. This success has been largely through informal tradition and voluntary discipline. The University recognizes that in order to transmit the traditions of its campus plan and architecture into the future it is time to establish formal design guidelines and standards. These guidelines and standards will assure a harmonious campus while at the same time encouraging architectural innovation and quality construction.

As electronic technology becomes more and more a part of the learning endeavor, the "truest record" of the University's life, its campus and architecture, will become more and more important symbolically. This increased importance of the "place" of the University--of the "great living spirit" of the University--will necessitate even greater architecture. It is to the achievement of that greater architecture that this volume is directed.

Updated from the 2002 original written by Dave Irvin, AVC/AVP Plant Operations.

UNIVERSITY OF HOUSTON CAMPUS DESIGN GUIDELINES AND STANDARDS

TABLE OF CONTENTS

SECTION

0.0 PREFACE

1.0 MISSION

- Nomenclature and Acronyms
- University of Houston System
- University of Houston
- Facilities Planning and Construction Department

2.0 INTRODUCTION

3.0 PURPOSE

4.0 FUNDAMENTAL CAMPUS VALUES

5.0 ARCHITECTURAL DESIGN GUIDELINES

- Overview
- Appearance and Architectural Features

6.0 LANDSCAPE DESIGN GUIDELINES

- Overview
- Landscaping of Campus Edges
- Landscaping of Gateways

- Landscaping of Campus Streets
- Landscaping of Parking Areas
- Landscaping of Walks
- Landscaping of Open Spaces
- Planting
- Irrigation
- Site Furnishings
- Lighting
- Landscape Plans

7.0 ENVIRONMENTALLY RESPONSIBLE DESIGN GUIDELINES

8.0 SPACE GUIDELINES AND UTILIZATION GOALS

- Space Inventory
- Space Guidelines
- Space Factors:

9.0 PARKING LOT AND PAVEMENT DESIGN STANDARDS

- Introduction
- Parking Lot Design
- Handicapped Accessible Parking
- Flexible Pavement System
- Sidewalks and Ramps
- Shuttle Bus Stops
- Security
- Drainage

- Lighting
- Striping and Marking
- Signage
- Parking Barriers
- Landscaping
- Maintenance and Repair
- Unforeseen Circumstances
- Working with Campus Staff
- Glossary

10.0 WAYFINDING STANDARDS AND GUIDELINES

- Introduction
- Exterior Signage
- Production, Installation, Maintenance, Replacement
- Interior Building Signage

11.0 EXTERIOR LIGHTING DESIGN GUIDELINES

- Overview
- Lighting Intensities
- Light Quality
- Fixture Locations
- Relative Lighting Intensity Sequence Diagram

12.0 CONSTRUCTION SYSTEMS AND ASSEMBLIES STANDARDS AND GUIDELINES [UniFormat Style]

- Introduction
- Facility Performance

- Element A / Substructure
 - A10 Foundations
 - A20 Basement Construction

- Element B / Shell
 - B10 Superstructure
 - B20 Exterior Enclosure
 - B30 Roofing

- Element C / Interiors
 - C10 Interior Construction
 - C20 Stairs
 - C30 Interior Finishes

- Element D / Services
 - D10 Conveying
 - D20 Utility Piping Systems
 - D30 Heating, Ventilating, and Air Conditioning (HVAC)
 - D40 Fire Protection
 - D50 Electrical

- Element E / Equipment and Furnishings
 - E10 Equipment
 - E20 Furnishings

- Element F / Special Construction

- Element G / Building Sitework
 - G10 Site Preparation
 - G20 Site Improvements

Addendum A -- Laboratory Buildings

Addendum A.1 – Laboratory Design Guide

Addendum B -- Security Systems Installation, Operations, and Support Program Standards

[This document has been withdrawn]

Addendum C – Classroom and Auditoria Best Practices

Addendum D -- Fire Alarm and Special Hazard Protection Specifications

- Section 05 21 00 Fire Suppression
- Section 05 21 10 Water Base Fire Suppression
- Section 05 21 20 Special Hazard Fire Extinguishing System
- Section 05 28 30 Electronic Detection and Alarm

13.0 APPENDICES

APPENDIX A: http://www.uh.edu/af/docs/CFP/041015_presentation_UHMasterPlan.pdf

SECTION 1.0

MISSION

NOMENCLATURE AND ACRONYMS

It is useful to clearly distinguish the names and acronyms used in this document for the University of Houston System, the University of Houston, the Facilities Planning and Construction Department, and the Design Consultants.

- **UNIVERSITY OF HOUSTON SYSTEM** (also referred to as "UHS" and "System") is the central administration which interfaces with the government of the State of Texas for the consortium of universities bearing the University of Houston name (University of Houston, University of Houston-Downtown, University of Houston-Northwest, University of Houston-Clear Lake, University of Houston-Clear Lake Pearland campus, University of Houston Sugar Land, University of Houston System at Cinco Ranch, University of Houston System-Texas Medical Center, and University of Houston-Victoria).
- **UNIVERSITY OF HOUSTON** (also referred to as "UH" and "University") is the original University of Houston, founded in 1927. This document is unique to the UH and its campus.
- **FACILITIES PLANNING and CONSTRUCTION DEPARTMENT** (also referred to as "FPC") is a System office that is in charge of the planning, design, and construction of all physical facilities for the System's component institutions, as well as those of the System itself.
- **DESIGN CONSULTANTS** (also referred to as "Designers" and "A/E") are the architects, engineers, landscape architects, interior designers, graphic artists, etc., with whom the System (through the FPC Department) contracts for the design of its buildings and facilities.

UNIVERSITY OF HOUSTON SYSTEM

[Additional information about the University of Houston's goals, mission and current initiatives can be found in the "About" section of the UH Website: uh.edu]

Board of Regents Priorities

Academic Excellence

To maintain status of excellence as a learning center through teaching reputation, classroom excellence, and becoming a provider of choice for employer recruitment;

To continue research achievements; and

To maximize student enrollment, retention, graduation, and subsequent successful entry into the educated work force.

Effective and Efficient Administration

To operate an education and research institution managed by an effective and efficient administration inspiring confidence and trust;

To become "Client Friendly" in our delivery of education and research; and

To create an environment fostering communication, coordination and collaboration among students, faculty, administration and community constituencies.

Community Relevance

To become more proactive in blending higher education with community service; and

To maximize UHS relevance to multiple constituencies within the Greater Houston Metropolitan area and the Upper Gulf Coast region.

Leadership

To position UHS as a leader in the dynamic and challenging environment of a metropolitan university system; and

To establish quality benchmarks, compatible with national Tier One and international standards of excellence, for a public research university system.

UNIVERSITY OF HOUSTON

Texas Higher Education Coordinating Board Approved

Provide a range of educational programs that foster an intellectually and culturally diverse environment that enhances individual growth and development.

To prepare a broad community of students (undergraduate, graduate, professional and non-degree seeking) to make lifelong learning commitments that result in personal, social, economic and community contributions to an increasingly globally interdependent world.

Create, discover, disseminate and preserve knowledge and understanding by engaging in basic and applied research, scholarly and artistic activities that benefit students, scholars and external constituencies. Serve as a major resource for local, state, national and global communities by applying scholarly analysis and experience to community problems. Recognize its special responsibility to the Houston metropolitan area by making the knowledge base and other resources of the institution readily accessible to its citizens.

Shared Values within the Mission

As its primary goal, the University of Houston is dedicated to enhancing its national recognition in the 21st century. The University will anticipate and respond to changing demographics in an increasingly diverse and globally interdependent world. It will use its resources to:

- Meet the challenges of educating a dynamic mix of nontraditional and traditional students.
- Promote excellence within the context of basic and applied research and scholarship.
- Identify and respond to the economic, social and cultural challenges affecting the quality of life in Houston, the state of Texas and the world through its education, research and service.

Priority Areas and Associated Goals

Undergraduate Education

Improve the quality of instruction and facilities to enhance undergraduate educational programs in each academic unit.

Graduate Education

Ensure that the quality of instruction and facilities result in high quality, nationally ranked graduate and professional education programs.

Research

Maintain the quality of research and enhance the level of productivity consistent with Carnegie Level I stature among higher education institutions.

Campus Environment

Build an environment that is inclusive, positive, humane and physically accessible where all participants (students, staff, faculty and visitors) feel welcome.

Outreach and Access

Increase the dissemination of knowledge and problem-solving skills between UH and society. Improve the accessibility of UH resources to society in general and to the Houston community in particular.

Enrollment Management

Ensure the proper balance of growth, retention and graduation of a diverse, knowledgeable and skilled undergraduate, professional and graduate student body.

Accountability

Recognize the need for accountability at all levels by establishing and maintaining comprehensive and systematic methods of assessment for: educational programs, institutes and centers, human resources, organizational structures and fiscal integrity.

UNIVERSITY OF HOUSTON SYSTEM FACILITIES PLANNING AND CONSTRUCTION DEPARTMENT

Mission:

*The mission of **Facilities Planning and Construction** is to deliver exceptional and enduring construction projects that maximize value and that support the University's Tier One strategic initiatives through superior facilities planning, project management, and quality assurance services of all University of Houston System components. Facilities Planning and Construction organization carries out its mission by providing professional support in the areas of campus planning, architecture, engineering, construction services, and directing the efforts of outsourced ventures.*

Core Values:

Integrity: professing honesty and credibility in all relationships, both as individuals and as a department and University.

Excellence: providing superior quality and high standards in all services.

Service: meeting the expectations and needs of the University community and federal and state regulatory agencies by providing timely response, quality, reliability, and excellence in all endeavors.

Leadership: providing noteworthy examples that emphasize high ethical and moral standards.

Sensitivity: displaying a sincere and caring attitude coupled with professional treatment.

Flexibility: displaying the ability to respond to a variety of tasks and responsibilities as well as being open to the vision of others.

Planning: prepare the campus to accommodate growth and technological changes by forecasting the University's future facilities needs.

Development: guide University development and ensure that the Campus Master Plan is kept current so that it serves as a comprehensive plan for University development.

Preservation: ensure that landmarks and other historic physical attributes of the campus are protected and restored so that present and future generations may fully enjoy the rich heritage of the University.

Budgeting: ensure that funds provided for projects and the operation of FPC are expended in a manner that maximizes benefit to the University and is consistent with all applicable laws and rules.

SECTION 2.0

INTRODUCTION

The mission of the Office of Facilities Planning and Construction is carried out at three levels: (1) overall campus planning; (2) planning and design of facilities including buildings, landscapes, and infrastructure; and (3) construction of facilities.

This volume records the *Campus Design Guidelines and Standards for the University of Houston*. The contents of this volume are intended to facilitate the work of architects, landscape architects, and engineers whose work for the UH affects the UH campus. The information is organized and presented from the general to the specific.

The "Planning Frameworks" are intended to inform the designers with the general ambience, aesthetics, order, and traditions of the campus as a whole. The "Architectural Design Guidelines" and "Landscape Design Guidelines" are intended to distill and focus those fundamental values as they apply to specific projects. The "Space Guidelines and Utilization Goals" are intended to assist the designer by providing certain fundamental area and space relationship information that is required to be part of the project. The "Construction Systems and Assemblies Standards and Guidelines" provide the designer with technical performance standards and specifications that are required in the project.

Also included in this volume is information concerning environmentally responsible design, parking lot design, campus lighting design, and interior and exterior wayfinding.

A "Project Planning Guide" documents each proposed design of facilities and records the compliance of the design to the guidelines and standards presented in this volume. The format and content of the "Project Planning Guide" are also contained in this volume.

SECTION 3.0

PURPOSE

The purpose of these guidelines and standards is to facilitate the understanding of what the University requires and desires of their designs among design professionals commissioned by the University of Houston to design facilities.

The University requires that the designs adhere to the general spirit of the “fundamental values of the Campus”; it requires the general application of the "Architectural Design Guidelines" and the "Landscape Design Guidelines" with respect to specific projects. The “fundamental values” derive from criteria developed by the University of Houston College of Architecture DesignLab the Campus Framework Plan developed by Cooper, Robertson, and Partners in 2006 and by earlier planning studies all of which are incorporated within Section 5.0.

Visually, the University's campus is green with trees from its original woods and from the perpetuation of those woods through constant replanting. Indeed, this wooded image of the campus is one of its most traditional symbols. The University desires to be a "Green" campus beyond the symbolism of its woods. To this end the University requires that its facilities projects be sustainable designs to the maximum extent possible under the scope of work and budget available to each project. The "Section 7.0 Sustainable Design Guidelines" explain what the University expects in this area.

The overall square feet needed to support Education and General functions may be predicted from formulae published by the Texas Higher Education Coordinating Board. The THECB also establishes building efficiencies for various project types and places requirements on the documentation and identification of building areas. “Section 8.0 Space Guidelines and Utilization Goals” provides more information on the THECB’s requirements.

When design of facilities involves new or remodeled parking, the "Section 9.0 Parking Standards and Guidelines shall apply to these facilities.

Some design projects require signage, both externally and internally. Section 10.0 Wayfinding Standards and Guidelines" will be incorporated into these projects.

There are a number of technical desires and requirements that are to be acknowledged in the design of the University's facilities. These requirements are both specific (prescriptive) and general (performance) in nature. The University publishes two documents identifying these requirements. The first, normally used in the conceptual and schematic design phases, is Section 12 of these guidelines: "Construction Systems and Assemblies Guidelines and Standards", which is organized in Unifomat style.

The second document, which is in CSI MasterFormat style, consists of the Master Construction Specifications (<http://www.uh.edu/plantops/departments/fpc/master-specs/index.php>) and is used from design development on in the design construction process.

The "Facility Program" is prepared with the assistance of the Facilities Planning and Construction Department. It summarizes the entire project, and forms part of the agreement among the Board of Regents, the System Administration, the Component's Administration, and the Project Planning Committee. The "Facility Program" also records the adherence of the consultant's design to the applicable Campus Guidelines and Standards.

Components of the "Facility Program" include:

- Department Mission Statement (*optional*)
- Justification Statement
- Owner's Milestone Schedule
- Design and Construction Schedule
- Applicable Codes & Owner's Design Criteria
- Site Considerations
- Architectural Overview (Height, Palette, etc.)
- Space List/Inventory
- Structural Overview
 - Foundation Type
 - Building System
- MEP Overview
 - Heating & Cooling Sources
 - Air Handling, Ductwork, Exhaust
 - Controls
 - Site Utilities
 - Lightning Protection
 - Emergency Power
- Fire Protection
- Cost Estimate/Construction Cost Limitation
- Source of Funds
- Delivery Method Type
- Outline Specifications (*if applicable*)
- Conceptual Site Plan, Floor Plans, and Elevations (*if applicable*)

The "Facility Program" documents the project, its program, its budget, its schedule and, if applicable, its schematic design for presentation to and approval by the University of Houston System Board of Regents, as required by that body in its policies. Current Board policies related to facilities construction and contract authorization can be found at <http://www.uhsystem.edu/board-of-regents/policies/index.php#SectionVI>.

Clarifications

SECTION 4.0

FUNDAMENTAL CAMPUS VALUES

The University of Houston has been graced with an original campus plan of the highest quality (1938, Hare & Hare) and several insightful updates of that plan (1966, Caudill Rowlett Scott; 1982, 3D/International; 1998, PGAL; 2006, Cooper, Robertson, and Partners). The latter effort, the 2006 Campus Framework Plan, expanded upon earlier goals of aesthetics and functionality and suggested a tri-partite (development, open space, and transportation) approach to campus growth. The UH Gerald D. Hines College of Architecture's professional research hub, the DesignLab, in its update to the Framework Plan in 2011 proposed further densification of previously developed areas and confirmed likely structured parking locations to support larger user groups in the arts, law, and engineering research areas (<http://www.uh.edu/about/initiatives/master-plan/index.php>).

The University of Houston has been graced with an original campus plan of the highest quality (1938, Hare & Hare) and several insightful updates of that plan, most recently by The UH College of Architecture's professional research hub, DesignLab. (1966, Caudill Rowlett Scott; 1982, 3D/International; 1998, PGAL; 2006, Cooper, Robertson, and Partners). The latter effort, the 2006 Campus Framework Plan, expanded upon earlier goals of aesthetics and functionality and suggested a tri-partite (development, open space, and transportation) approach to campus growth. , in its update to the Framework Plan in 2011 proposed further densification of previously developed areas and confirmed likely structured parking locations to support larger user groups in the arts, law, and engineering research areas (<http://www.uh.edu/about/initiatives/master-plan/index.php>).

As the University implements recent master planning, it will:

- Reinforce, interpret and replicate the courtyards in size, scale, and landscape.
- Create mixed use districts throughout the campus where housing, academics, and entertainment are intermingled.
- Introduce before and after activities into the campus—more housing, food, cultural and entertainment settings, and recreational places.
- Promote street connections, highlight shared facilities, and create development partnerships between neighborhoods and the university.

- Increase structured parking and locate surface parking at the perimeter of the campus adjacent to major roads, reinforce the campus center as a pedestrian world, and facilitate the University community's use of mass transit.

Design values established in earlier campus plans remain relevant:

- Delineate the campus with consistent landscaping around the perimeter. Welcome people to the campus with a system of gateways and portals.
- Embrace the neighborhood by responding to the concerns of appearance, traffic, security, and quality. Understand the types of neighbors: residential; industrial; freeway; and Texas Southern University.
- Perpetuate the remnants of the original campus woods. Replant trees simulating a natural pattern in order to reclaim the wooded character of the campus.
- Preserve architectural character by honoring the notion of a "family of buildings," in which all share a common visual vocabulary and appear related **but the designs of which are not repetitious and do not lack design innovation.**

SECTION 5.0

ARCHITECTURAL DESIGN GUIDELINES

NOTE:

The "Architectural Design Guidelines" outline the external architectural features and exterior building materials that shall be considered in a proposed architectural project at the University of Houston campus. Other related University of Houston documents include the Campus Master Plan (http://www.uh.edu/af/docs/CFP/041015_presentation_UHMasterPlan.pdf) and the "Landscape Design Guidelines" (Section 6.0).

5.1 OVERVIEW

5.1.1 Preface

The "Architectural Design Guidelines", together with the "Landscape Design Guidelines" and campus master plan (updated approximately every 5 years) outline the fundamental design criteria which sustain the existing cohesive attributes of the University of Houston ("UH") campus and provide a flexible framework for future in-fill and expansion projects. The Guidelines outline the materials and features which enhance both the "urban" and the "forest" images of the campus. The intent of the Guidelines is not to create visual uniformity at the UH campus but rather visual harmony. As tools for campus development, the intentions of these guidelines are:

- To identify the range of materials and features that are shared by the collection of buildings
- To limit or exclude materials and features which are visually disruptive to the recognition of cohesive campus places
- To encourage the invention of spaces and places which sustain a diversity of urban academic life styles and reinforce the cultural role of the UH within the Houston community

5.1.2 Challenges

In January 2011, the University of Houston was acknowledged as one of only Carnegie-designated Tier One research universities in Texas. To solidify its Tier One position, the University must continue to broaden its overall excellence and strengthen its performance and reputation for student success. This effort challenges the physical growth of the campus in several ways. First, the amount of classroom, office, auxiliary, and support space, and utility infrastructure must grow to accommodate a significantly larger student body while maintaining the campus' attractive open spaces and without losing its casual appeal. Secondly, the campus must transform from an almost exclusive commuter campus to a place where students live, learn, and socialize on campus as part of their educational lifestyle. New mixed-use development housing, integrating academic space, retail and entertainment, the arts, and social venues, must be constructed to cater to first-generation college students, working students, students with families, and students who tend to be older than most collegians.



5.1.3 Campus Context

Viewed as a whole, the UH campus is a clearly identifiable “place” within the Houston landscape. Recognized by its clusters of large, institutional buildings grouped within a park-like setting, the campus appears as a unique environment set between the surrounding residential landscape on the south and west and the freeway and industrial districts on the north and east. At its perimeter, the visual recognition of the campus is primarily a result of three conditions. First, the scale of the campus buildings, as a group, contrasts with the surrounding urban context. Second, the building clusters within the campus are predominantly finished with masonry, stone, or concrete in buff colors. Third, these buildings are sited in a contiguous park-like setting dotted by large open parking areas. These common attributes of scale, materials, and setting define the visual framework that forms the campus image at UH.

In addition to its overall institutional form, the campus is enhanced by the presence of architectural and landscape features that encourage and orient pedestrian movements. Throughout the campus, this collection of plazas, courtyards, sculptures, terraces, loggias, woods and lawns, etc., establishes an “urban forest” quality that is distinctive to the UH Campus. While these architectural and landscape features may sometimes be obscured or isolated, they are, nonetheless, significant visual attributes that define the campus as a “public urban university.”



A unique quality of the UH campus is the commitment to public art in the form of environmental sculpture. The extent and quality of sculpture integrated into the entire campus is a wonderful characteristic that must be embraced and continued in the development of the expanded campus. Whether found in large open areas at the visual terminus of a formal pedestrian way, along the side of a walkway among trees, or in buildings the public art enriches and enhances the campus experience.

5.2 APPEARANCE AND ARCHITECTURAL FEATURES

5.2.1 Permanence

One characteristic of an institution is a pervasive sense of permanence. This may be achieved through building materials, size and shape of buildings, quality of master planning, architectural design quality, and site and building maintenance. Metal buildings, for example, although appropriate for industrial settings and even as temporary facilities, do not fit on the UH campus. The economic investment traditionally assumed in a university demands enduring materials. Likewise, to acquire enduring materials requires adequate economic investment in the structure and the quality of design.

5.2.2 Color Palette

A simple, consistent color palette can do more to provide a sense of visual unity across a campus than any other element. It is closely tied, of course, to the actual materials but a variety of materials and textures can be unified by sharing a common color. The basic color palette was set with the six buildings of the original campus plan. These buildings were constructed with what at the time were “regional materials” (i.e., Texas shell limestone and clay tile roofs). Other key colors were the soft gray of cast aluminum and the patina green or dark brown of weathered copper. As more contemporary structures are built, exterior finishes recall the palette of the historic early days of UH.

- Walls should be a light warm beige or buff.
- Pitched roofs should be terra cotta (brownish/orange) or copper patina green.
- Window framing should be a natural metal color chosen from a range from clear anodized to zinc gray.
- Glass shall be nominally clear—without mirror finish. FP&C will consider the use of tinted or fritted glass when necessary to meet the requirements of the energy code.

A related color theme is the strong greens of the landscaping that are a key to the overall “urban forest” appearance of the campus. The predominance of lighter colors or tones in the buildings contrasts nicely with the darker, richer colors and shadows of the landscape. Occasional accents of color in plants or sculpture are preferable to bright colors on the buildings.



**Original Color
Palette**

The use of colors in the brickwork on the Music Building, albeit tasteful and in keeping with the palette, is perhaps the extreme limit for this campus. Similarly, the red tile on the Science Engineering and Research Classroom auditorium establishes the limit for accents, both in quantity and intensity of color,

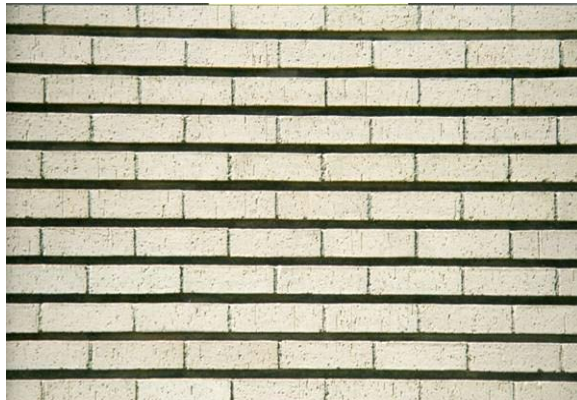
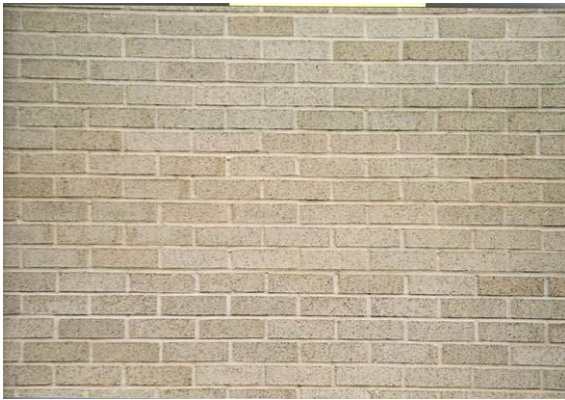
for this campus. On the other hand, the same buff brick has been used on many buildings but by varying the color of the mortar, or by blending with other brick shades, the overall tone of the walls is varied noticeably while remaining within the “family” concept. Recent construction has incorporated, in small areas, the use of red on an interior face of spandrel glass, which provides a bold and low-maintenance splash of color.



Detail of materials in dormitory group



Brick colors in Moores' Music School



Variety of wall surfaces achieved through different mortar joints

5.2.3 Massing and Scale

The original UH campus core buildings were thinner in cross-section than contemporary buildings due to design constraints for natural ventilation versus air conditioning today. The older buildings have pitched roofs, at least over segments of the buildings, if not totally, whereas modern structures have broader footprints less suitable to pitched roofs. The predominant massing of later buildings is based on geometric proportioning with flat roofs and parapets and using modulation of surfaces and fenestration or interplay of simple geometric shapes to establish variations in the façades and to express plan features.

- New buildings should respond to the predominant massing and strategy of the surrounding buildings.
- In all cases, designs should contribute to the human scale and proportions of a pedestrian-oriented campus.
- The creation and definition of open spaces is a key strategy for the UH campus. New buildings should be designed to enhance and frame public spaces, malls, and courtyards.
- Buildings must be designed as part of the campus as a whole and as part of the local precinct—the local system of open spaces and linkages. They will not be standalone icons set apart in a field.

5.2.4 Height

The campus is populated by low-rise (2-3 story) to medium-rise (7-10 story) buildings, with the only exception being the 18 story Moody Towers residence halls. This is appropriate to the “urban forest” setting and the perceived density of the historic center of the campus. The university does not attempt to meet the strict LEED criteria of a minimum 60,000 GSF of development per acre, but is steadily improving its density. All new buildings will be a minimum of 4 stories tall, and parking lots will be replaced by parking structures in order to use land more efficiently. As a general rule however, buildings should remain at or below the 75-foot height that is used in building codes as the threshold for application of high-rise building safety requirements.

5.2.5 “Monumental” or “Fabric”

The primary focus of these guidelines is to enhance the notion of a “family of buildings,” i.e., that the collection of buildings, considering all variations of style, size, function, and age, should share a common visual vocabulary and appear related without stifling architectural innovation. In general, each individual building should first establish its identity within the greater whole of the campus fabric and then present its individual identity. Visually speaking, all new buildings should contribute as supporting members of the campus image and as components of the network of public spaces. Unique “object” buildings, which in their architectural expression or form are aberrant from the campus norm, will not be allowed.

However, there is a place for, indeed, a need for the occasional “monumental” building to give focus or visual delight within an area of the campus. “Monumental” buildings are those which occupy prominent positions, such as at the end of a quadrangle (E. Cullen), or a major axis (Architecture), or a corner of the campus (Center for Public Broadcasting). The massing and architectural details of these buildings should belong to the campus family but may be more dramatic in keeping with their function and location. “Fabric” buildings, in contrast, are visually subordinate, require less detailing, and whose massing can be simpler. However, these buildings should still be fine and handsome in appearance.

5.2.6 Loggias

Some of the harsh aspects of the Gulf Coast region are the semi-tropical climatic conditions of hot sun, heavy downpours, and high humidity. The architecture of the original core campus buildings and many of the later modernist buildings does not include covered walkways, either freestanding or as part of the building. However, some of the buildings do include this element, which is a fine feature for protecting pedestrians from this climate. Well-lit walkways are a security enhancement at night as well. Loggias are recommended for all new facilities and for retrofit studies as well. Eventually, large areas of the campus could be linked with a series of colonnades tied to loggias or similar features. Therefore, buildings are encouraged to provide recognizable features such as loggias or overhangs or porches, which support pedestrian movements across campus.



Existing Loggias at Agnes Arnold Hall, PG Hoffman, Science Engineering Classroom

5.2.7 Entrances

A feature of older structures is the clarity of where the entrances are. Whether a symmetrically balanced façade or an asymmetrical design, the entrances were obvious, either through prominent appendages or dramatic recesses and overhangs. Many of the modern buildings on campus subordinate the entrance within the geometry and massing to the degree of its being difficult to locate. Architects are encouraged to seek ways to provide visual clues to the entrances. Entrances should be prominently defined as part of the architectural statement of the façade.



Examples of Well-Defined Entrances

5.2.8 Special Details

Architects are encouraged to include special elements of interest or delight in the exterior façades. The following are a few ideas:

- Dedication plaques and cornerstones, common on older buildings around campus, are also required on new construction and significant renovation. Refer to Section 10: Wayfinding for dedication plaque requirements.

- Building identification, whether inscribed in stone lintels or lettering applied to the façade, is crucial to orientation and should be considered early in the design process. Wayfinding is greatly enhanced when buildings (and entrances) are clearly identified in this manner. This also contributes to the sense of permanence mentioned elsewhere. However, being able to change the name for a later donor or changed function should be considered as well.
- With the expansion of evening courses and late building usage, concepts of “nocturnal architecture” bear consideration. This means functional as well as dramatic lighting, and the incorporation of CPTED (Crime Prevention Through Environmental Design) security practices.
- Inclusion of art, whether freestanding sculpture or murals or integrated into building elements, etc., is encouraged and may be required by some building programs.
- In the creation of outdoor spaces surrounding or formed by buildings, opportunities for use as alternative classrooms and “living rooms” should be considered.

SECTION 6.0

LANDSCAPE DESIGN GUIDELINES

NOTE:

The “Landscape Design Guidelines” outline the external landscape and open space features and elements that shall be considered in any proposed landscape project on the University of Houston campus. As a section of the University of Houston Design Guidelines and Standards, all codes, ordinances, and conditions that apply to the University of Houston System Procurement and Delivery Procedures also apply to the “Landscape Design Guidelines.

6.1 OVERVIEW

6.1.1 Preface

The original UH Campus Plan developed by Hare & Hare in 1937 established a formal framework of buildings, spaces and connections organized along axial lines. In contrast, actual campus landscaping practice duplicated the informality of the natural surroundings, particularly the woods as they extended from Brays Bayou. As the campus itself grew, the park-like nature of the campus increased, as roads were closed, axes were blocked and auto circulation was routed around the perimeter of campus with limited penetration.

Departing from the axial framework, developments after 1966 adopted a more informal and spontaneous pattern of building locations while still adhering to the orthogonal orientation of the original plan. More recent developments have focused on strengthening the axial pathways and transforming the open space between buildings from left over space into active spaces which engage with the neighboring buildings.

The intent of these landscape guidelines is to achieve a high level of quality in the design of landscape treatments while maintaining an order and structure to the campus, cultivating visual interest and biodiversity; and providing a conceptual framework for a distinct campus identity.

Landscape objectives include:

- A pedestrian campus which prioritizes its open spaces.
- Generous tree areas with a goal of a tree canopy equaling 40% of total land area
- Integrity of core campus’ open spaces while accommodating facilities’ growth.
- New campus gathering places of varying character that are harmonious with the scale of existing surroundings.
- Physically identifiable and pleasing presence of the campus upon arrival.
- Extension of the indigenous landscape and recreational uses of the adjacent bayou park system into the campus.

- Inclusion of native plantings which acknowledge the seasons, and shade and water elements.
- Appropriately lit exteriors which support nighttime activities and promote security.
- Support for key CPTED (Crime Prevention Through Environmental Design) security concepts: natural surveillance, natural access control and natural territorial reinforcement. The City of Houston provides a good resource for this design strategy at http://www.houstontx.gov/police/pdfs/cpted_infopage.pdf.

6.1.2 Variance from Government Code

Texas Government Code Section 2166.404, requires xeriscape landscaping design on new construction projects. However, Houston’s high heat and humidity, claylike soils, and high water table conditions vary from the dry environmental conditions suitable for typical Texas xeriscape landscaping. The University of Houston practices water-saving landscaping by appropriate plant selection, limiting turf in perimeter areas, efficient irrigation, and generous mulching.

6.1.3 Tree Campus USA

The University of Houston Sustainability Committee, in partnership with Facilities/Construction Management and TAMU Urban & Community Forestry, is implementing Tree Campus USA score standards of tree care and community engagement. Elements of the “Campus Tree Care Plan” recommended by the Arbor Day Foundation have been incorporated into this landscaping guideline.

6.2 LANDSCAPING OF CAMPUS EDGES

6.2.1 General

Establish standards for the landscape treatment of campus edges and for the creation of a distinctive, positive image that fixes the University within a landscape context that represents the University and the environment of the region. Landscape treatments shall consider urban design elements such as sense of place, sense of entry, view corridors, visual buffering, adjacent land uses, natural features and connection to the host community. Consideration shall also include the concept of extending and reinforcing the bayou woods particularly along Martin Luther King Blvd.

During schematic design of major building projects on campus, representatives of Campus Planning and Landscape Planning & Grounds shall be involved with the design consultant in design decisions and the overall vision of the landscape scheme.

6.2.2 Recommendations

The scale and character of the Campus edges that front highways is greatly influenced by the speed and distance of motorists that pass by the campus or enter the campus. The scale of plantings along the highway shall consist of large massing of trees that reflect both the formal and informal characters of campus. Consider view corridors, alignment, points of reference, and screening where appropriate.

The scale and character of campus edges adjacent to surrounding districts and neighborhoods shall communicate a strong sense of a campus threshold without creating a physical and visual barrier. Consider crossable boundaries that allow unobstructed pedestrian and vehicular access.

The natural woods that extend through the Campus from Brays Bayou shall be expanded to accentuate the bayou connection and to act as a landscape buffer between the surrounding highways and the Campus.

6.3 LANDSCAPING OF GATEWAYS

6.3.1 Existing Condition

UH has two major entrances possessing landscape features of the type and scale to create a sense of arrival on the campus. The Cullen Blvd. Entrance from I-45 achieves this with a pair of split granite obelisks at the northern end, and with flanking rows of oak trees and ornamental light posts and banners. University Drive off the Spur 5 access road has similar edge conditions and terminates in the campus' most iconic building, Ezekiel Cullen. Elsewhere on campus, the construction of the Health & Biomedical Science Building adjacent to the Armistead Optometry building, together with the METRO Southeast Corridor light rail station on Wheeler Street at MLK Blvd., has created another gateway condition at the southeast corner of campus.

6.3.2 General

Substantially enhance and beautify the landscape treatment at the appropriate locations to create significant gateways commensurate with a major university and create a memorable front door image. Gateways should be appropriately scaled.

6.3.3 Recommendations

6.3.3.1 Major Gateways

Major vehicular gateways shall be appropriately reinforced with landscape and architectural features to signify entrance and arrival. Gateway walls, monumentation, graphics, and colors shall be in scale with a major institution. Landscape elements shall be bold and simple in arrangements, massing, and alignment.

Consideration shall be given to view corridors, alignment, points of reference, and screening where appropriate; and to utilizing tall vertical gateway elements similar to the Cullen gateway (without duplicating the style).



FIGURE 6.3.1 MAJOR GATEWAY (CULLEN GATEWAY)

6.3.3.2 Portals

Portals, entry points to the campus less significant than gateways, shall be appropriately reinforced with landscape and architectural features to signify entrance and arrival. Portal walls, monumentation, graphics, and colors shall be in scale with a major institution but also in scale with the surrounding community. Landscape elements shall be simple in arrangement, massing, and alignment. (See **Figure 6.3.2**)

Consideration shall be given to view corridors, alignment, points of reference, and screening where appropriate. Portal size shall strike a balance between vehicular and pedestrian scale.

Materials and color for Portals shall be uniform and consistent throughout campus.



**FIGURE 6.3.1
PORTAL**

6.4 LANDSCAPING OF CAMPUS STREETS

6.4.1 General

Establish structure and clarity for vehicular circulation routes by utilizing consistent landscape treatment on the internal circulation routes and on the approaches to the UH campus, existing and proposed. Landscape treatments shall reinforce vehicular corridors, and shall project a campus image in the streets surrounding the campus.

6.4.2 Recommendations

Internal campus streets shall have a single row of regularly spaced canopy trees along both sides of the street continuing for the entire length of the street. Use of a singular species for each street with a spacing of 30'-40' on center is recommended. Trees may be different species for different streets, but mixing species within any particular street is discouraged. The trees shall be regularly spaced in a consistent alignment to distinguish them from adjacent landscape treatment and to reinforce the vehicular corridors. The ground plane shall be predominantly sod, with low maintenance groundcovers or native shrub areas at special points or entrances, if appropriate. Walkways shall border both sides of the street.

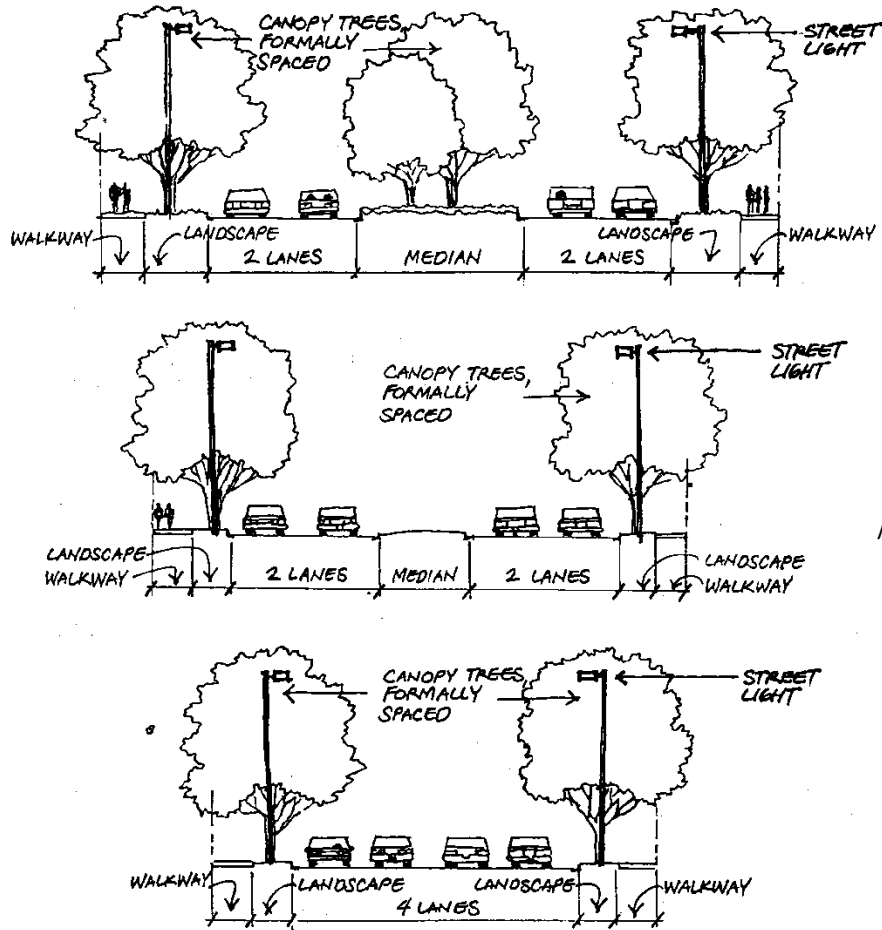


FIGURE 6.4.1
LANDSCAPING OF CAMPUS STREETS

Work within an overall conceptual framework for development of landscape elements on the campus. Establish a street tree planting based on a hierarchy of street types. Reinforce and extend current street tree planting program. Coordinate street landscape treatments with walks, lights and signage.

6.5 LANDSCAPING OF PARKING AREAS

Refer to **Section 9.13** of the Campus Design Guidelines and Standards for landscaping requirements of parking areas.

6.6 LANDSCAPING OF WALKS

6.6.1 Existing Condition

Sidewalks shall be standard broom finished concrete. There is, however, a significant amount of existing exposed aggregate concrete walks and care shall be given in transitioning between existing aggregate-finished walks and new broom-finished sidewalks.

6.6.2 General

Observe a hierarchy of systems, typology, scale, consistency of materials, and structure of pedestrian walkways to help define and articulate open spaces and enhance campus wayfinding. Create a more intriguing walkway environment. Promote and encourage a lively urban pedestrian environment in the streets surrounding the campus.

Differentiate between formal walks such as pedestrian malls and informal walks that follow a natural pattern of circulation.

6.6.3 Recommendations

Existing campus walks are characterized by curving, diagonal, intersecting and parallel walkways that reflect strong natural desire lines. Walkways that interconnect courtyards and academic clusters shall also follow the concept of diagonal walkways respecting desire lines and parallel walkways adjacent to vehicular circulation routes.

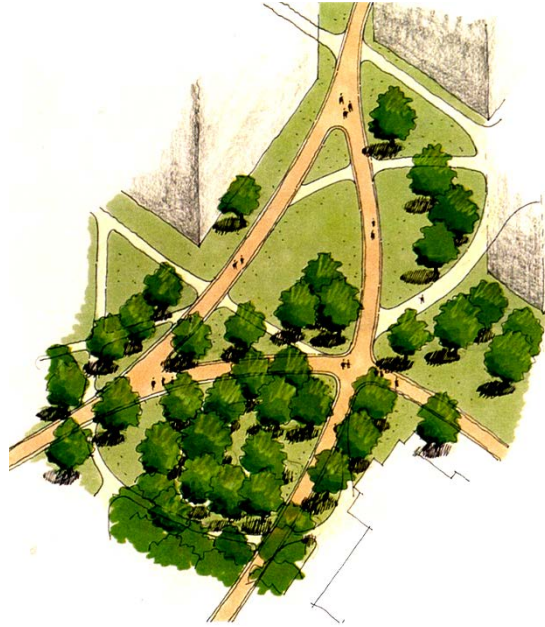
A primary walk system shall be developed that establishes a hierarchy of walks, with a select few given dominance over the existing walks. Priority should be given to major pedestrian routes by creating wide sweeping continuous pedestrian walks. **(See Figure 6.6.1)**

All other pedestrian circulation systems should be subservient but complementary to the primary pedestrian walk system.

For all pedestrian circulation typologies, there shall be established a hierarchy of materials and dimensions. As a rule of thumb, all walkways shall be designed to carry light vehicle traffic. Refer to Design Guideline Section 9.4 for additional paving criteria.

Walkways and special pavements shall not become subservient to individual buildings and their complementary materials. The width of the pedestrian circulation routes shall vary and be established by hierarchy, usage and urban design considerations.

A common palette of materials shall unify the entire campus. As a base material, concrete shall be the dominant walkway material. The finish, scoring and connection details shall be consistent and uniform. Special materials, patterns, banding, etc., may be used to articulate Pedestrian Malls, Plazas, or special features. Paved pedestrian entrance areas shall be simple and relate to overall pavement of open space circulation. Heavily articulated and patterned pavement is discouraged unless consistent with Pedestrian Malls or major campus circulation treatment. Pavers are not allowed.



**FIGURE 6.6.1
WALKS**

6.7 LANDSCAPING OF OPEN SPACES

6.7.1 General Guidelines

There exist on campus a large number of spaces that vary considerably in size, condition, formality, and significance. Some have been formally identified as named spaces, others are known by association with surrounding buildings or streets, and others are proposed for future development within recent master planning exercises.

This section establishes landscape treatments for various open space typologies, based upon the following categories of campus structure:

- Quadrangles, Courtyards, Plazas
- Pedestrian Malls
- Pedestrian Nodes
- Campus Greens
- Outdoor Gathering Areas
- Athletic Fields
- Planting Areas Around Buildings

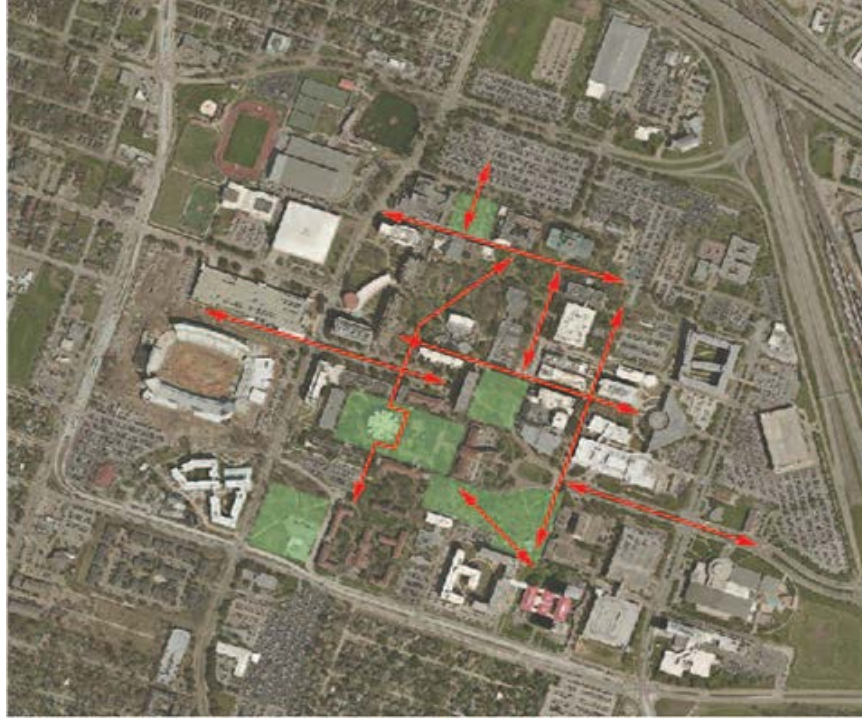


FIGURE 6.7.1
MAJOR LANDSCAPE AREAS AND PEDESTRIAN PATHS

6.7.2 Recommendations

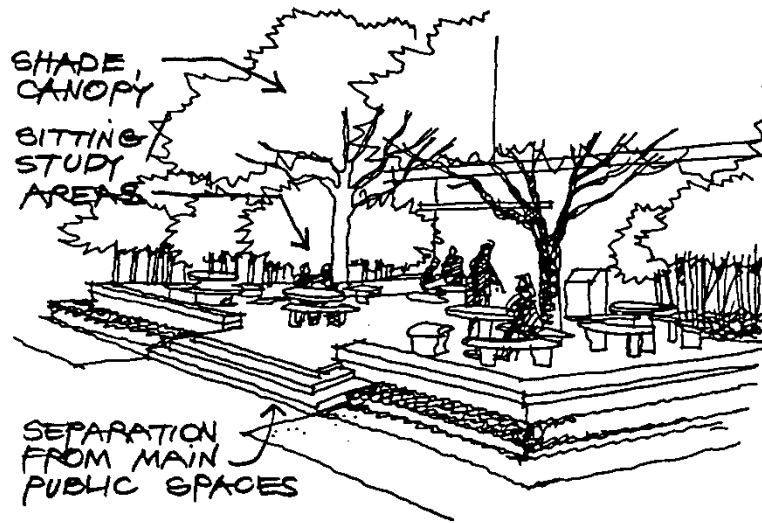
6.7.2.1 Courtyards

As noted in prior land use development plans, an open space system allows the existing linear walks and paths to extend the campus. Over time, new courtyards are anticipated which will be similar in size and nature to the many that exist today and which will serve as front door addresses for new buildings within each district.

Landscape treatment shall utilize walkways that parallel and define the boundaries of the courtyard. Simple, open, grass areas and tree massing shall reinforce the open space. Plant groupings can be formally or informally spaced, but the overall treatment shall re-enforce qualities of space and place within the courtyard. Individual landscape treatment of buildings, as they abut the courtyard, shall reinforce the totality of the courtyard and its special sense of place. Features such as fountains, monuments, sculpture, and special site furniture can occur at selected intersections of walkways and expanded pavement areas. (See Figure 6.7.2)

In addition to spatial reinforcement, the placement of landscape treatment shall reinforce significant visual straight lines, points of connections, axial relationships and building entrances. Pedestrian lighting, street furniture and signage shall also complement and reinforce the sense of a unified open space. Courtyard landscape treatments shall set them apart from Pedestrian Malls.

Courtyards shall also include seating areas for informal study and shall provide areas of sun and shade.



**FIGURE 6.7.2
COURTYARD**

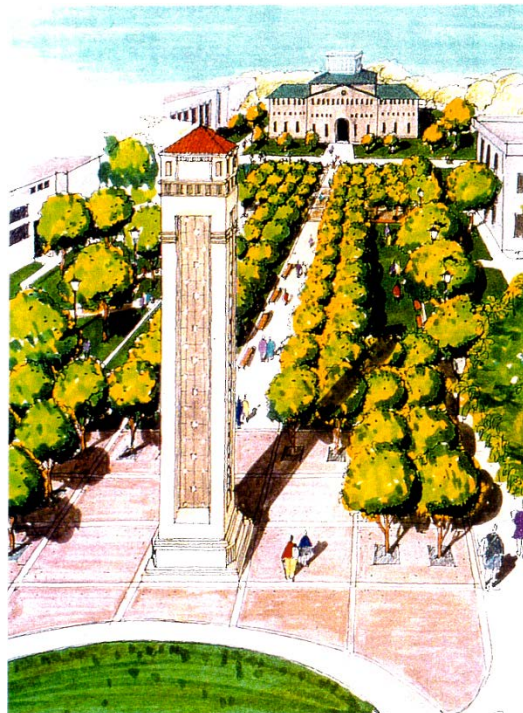
6.7.2.2 Pedestrian Malls

A Pedestrian Mall is a significant linear pedestrian promenade. (See **Figure 6.7.3**) It accommodates a significant volume of pedestrian traffic and functions as a major collector and as a major linear open space. At significant intersections and connecting points, the Pedestrian Mall shall be highlighted with an expanded plaza, which will serve as a focal point and meeting place. Significant features include regularly spaced, large canopy trees of a single species forming a shaded esplanade flanking an expansive lawn. Landmarks shall be considered as termini to the Mall. (See **Figure 6.7.4**)

The mall shall be detailed with special pavement and/or accent banding to provide interest and pedestrian scale. The materials selected shall be elegant, simple and timeless. The pavement material shall also be capable of being repaired and replaced with ease and consistency. The placement of benches, pedestrian lights and landscape shall reinforce the linear aspects of the mall. The mall design should facilitate strong directional movement. (See **Figure 6.7.2.2**)



**FIGURE 6.7.3
PEDESTRIAN MALL (FUTURE ARTS WALK)**



**FIGURE 6.7.4
CAMPUS LANDMARK (CONCEPT IMAGE)**

6.7.2.3 Pedestrian Node

Where there is a major confluence of pedestrian traffic, a pedestrian node shall celebrate the intersection as a special meeting place and point of reference. The pedestrian node shall function as an oasis characterized by a dominance of paving and tree canopy. Consideration shall be given to landscape treatments which are more urban in character, such as tree pockets, seating and special features, e.g. specimen plant material, fountain, kiosk, etc. Coordinate with Campus walks, lights, and signage.

6.7.2.4 Campus Greens

Campus Greens shall have a completely different character than the structured organization of quadrangles and malls. Literally parks, the Greens are informal open space corridors that meander through Campus in park like settings. Large drifts of tree massing shall define and reinforce Greens edges, screen out adjacent uses and generally create a very naturalistic open space/park area that is in sharp contrast to the rest of the campus. Flowering trees and a variety of plantings shall emphasize an arboretum-like display. Large, expansive lawns shall offset and complement large areas of shade and canopy. Walks shall be naturalistic and meander through the Greens. Greens can be remnants of the existing bayou woods or they can be man-made areas that emulate the natural character of the woods. Coordinate with Campus walks, lights, and signage.

6.7.2.5 Outdoor Gathering Areas

The Campus Master Plan for 2015-2020 (DesignLab) identified the following landscape goals:

Achieve a destination campus with signature pedestrian corridors linking housing, classrooms, research assets, and student life amenities.

Construct outdoor gathering spaces between research clusters and academic units to further collaborative engagement.



**FIGURE 6.7.5
CAMPUS GREENS (FINE ARTS GROVE)**

Collaborative outdoor spaces are envisioned for each campus district; the first example of which is the redeveloped Grove in the Arts district. (See **Figure 6.7.5**)

6.7.2.6 Athletic Fields

If feasible, athletic fields shall be located and organized to reinforce vistas into campus and views of landmark buildings. The fields shall consist of large grassed areas defined by ample massing of trees. The planting of trees between and around fields shall create large, outdoor rooms that scale down expansive open space. Landscaping shall also buffer and transition the fields from parking lots and building zones. Fields shall be integral with the Campus open space framework of shaded pedestrian walks. Coordinate with Campus walks, lights, and signage.

6.7.2.7 Landscaping Adjacent to Buildings

Landscape treatment adjacent to buildings shall be simple with a limited plant palette. Massing and size of planted areas shall be in scale with buildings and complement or reinforce the landscape of the open space areas and the campus landscape character. Mow strips are mandatory.

Landscape treatment shall consider reinforcement of main entrances, side and back yards. Placement of trees shall reinforce the architectural elevations. Priority shall be given to issues of safety and, therefore, heights of shrubs and small trees shall be limited to ensure adequate sight availability. Consideration shall be given for year-round color.

Dumpster yards and service areas shall be fully screened from general view using concrete walls, brick, block or other architectural materials that are complementary to the adjacent building. Hedges and buffer plantings surrounding the walls are encouraged.. Coordinate location with campus walks, pedestrian light poles, and signage. (See **Figure 6.7.6**)



**FIGURE 6.7.5
LANDSCAPING ADJACENT TO BUILDINGS**



**FIGURE 6.7.6
SERVICE AREA SCREENING**

6.8 PLANTING

6.8.1. General Guideline

In conjunction with buildings and facilities, planted areas shall serve to strengthen campus identity, reinforce open spaces, and create a comfortable environment. Campus planting, especially oak trees, street trees, and park-like settings, shall also establish a structure of continuity for the campus, helping to tie old and new sections, and the many architectural styles, together into a cohesive statement.

Over the last several years, earlier landscape guideline recommendations related to formal tree planting, native plants, and specialty gardens, and have been realized. A palette of plant materials for use on campus (please contact Architectural Landscape Manager for this information) has been developed which supports an attractive, harmonious and easily maintained landscape. An energy-efficient, environmentally responsible irrigation system has also been widely implemented, and a landscape master plan continues to develop.

Landscaping treatments vary across the campus. The core campus (the area bordered by Elgin, Calhoun, Wheeler, and Cullen) is treated consistently with turf acting as the primary surface to allow for student recreation. Where turf will not grow ground covers are desirable, and decomposed granite may be used sparingly in challenging growing conditions and in special accent areas. Live oaks are the dominant tree in this area and asian jasmine planting beds are at installed at their base.

As the landscape nears the core campus edges, landscape treatments transition to more drought tolerant, and in some cases more arid, schemes.

Visual coherence and consistency shall be achieved with the use of a limited plant palette. However, biodiversity should be a priority because over time this allows for less maintenance and more resilient trees. The overall campus landscape shall be not only unified, but shall also display a regional and indigenous character.

Functional and aesthetic design shall consider scale, hierarchy, context, adjacencies, spatial definition, screening, buffering, shade, view corridors, and seasonal color. Landscape and plant material shall complement the building and articulate main entry points and provide transitional zones between buildings area and larger, common open spaces and circulation areas. Plants shall also buffer or screen unsightly areas and reinforce larger landscape systems such as pedestrian malls and streetscapes.

Long-term maintenance requirements are a consideration for plant selection. Longevity and permanence are also a significant factor. Plants that grow quickly, thereby requiring more maintenance, pruning, etc., are discouraged. Additionally, plantings shall be designed and located in a manner that is conducive to easier maintenance. For instance, a landscape zone that has a multitude of species will require greater maintenance than a simpler mass planting of a single material with an occasional accent plant.

Personal security and safety is a significant factor in selecting plant material and specifying their location. Coordinate with DPS regarding plant/tree height and campus security and safety needs. Generally, there should be a clear visual zone between approximate knee height and sight line (or underside of the tree canopy) for all plantings to allow unobstructed views.

All landscaped areas shall be permanently and adequately irrigated as described in section 6.9 below. Existing and/or relocated trees and plants shall be protected and moved according to UH grounds maintenance requirements. (See Master Specification Section 01 50 00: Temporary Facilities and Controls.)

The final selection of plants chosen for use should be based on the following characteristics: low maintenance, low water use, long life, native or indigenous to the region; and non-native plants that thrive in this locale. The University requires that all new trees have a minimum caliper of 4” at installation. Final plant selection shall be coordinated with the UH Landscape Project Manager.

6.8.2. Other Landscaping Recommendations

- Employ the published standard for the selection of plant material for use on campus.
- Encourage use of landscape buffer at the building perimeter
- Work within the current campus master planning.
- Preserve existing trees, particularly the remnants of the existing woods (post oaks).
- Replace any trees removed due to new construction or renovation projects. Replacement trees shall match or exceed caliper inch per caliper inch of trees removed during construction. If space to plant similarly calipered trees does not exist, (with the approval of the UH Landscape Project Manager) larger caliper trees may also be used or replacement trees may be located on alternate sites.
- Consider a University tree farm to ensure a reliable supply of trees for the Campus.

6.8.3. Prepared Soil Mix:

Soil mix for exterior planting beds shall be a weed free mix of 20% sharp sand, 40% composted pine bark or rice hulls, and 40% topsoil.

6.8.4. Mulch:

Mulch material for exterior planting beds shall be double shredded hardwood mulch.

6.8.5. Gravel: Gravel shall not be used in planting beds.

6.8.6. Decomposed Granite may be used sparingly in challenging growth areas and in special accent areas with permission of Architectural Landscape Manager.

6.8.7. Turf:

Turf shall be 100% Raleigh St. Augustine sod (*Stenotaphrum secundatum* "Raleigh") for partial shade locations or Bermuda (*Cynodon dactylon*) for primarily sunny locations.

6.8.8. Staking and Guying Materials:

Stakes for bi-staking trees shall be 8-foot T-posts stakes.

Wire guys for tree support shall be pliable No. 10 gauge galvanized wire.

Hose for chafing guards shall be new or used two-ply fiber reinforced garden hose of not less than 3/4 inch diameter. One color shall be used throughout the job. *Alternate:* Metal T-Post may be used.

6.8.9. Root Stimulator

Green Light Root Stimulator and Starter Solution (5-20-10) or equal.

6.8.10. Planting Beds

Planting beds shall receive a minimum of four inches of prepared soil mixture, tilled thoroughly with existing soil until a homogenous mixture is achieved to a depth of six to eight inches. EPTAM pre-emergent herbicide shall be incorporated thoroughly at the rate of 20 lbs. per 1000 sq. ft.; and 13-13-13 fertilizer at the rate of 8 lbs. per 1000 sq. ft. into the top three inches of the prepared planting bed.

Prepared beds shall be mulched with two-inches of composted mulch.

6.9 IRRIGATION

6.9.1. PVC Pipe & Fittings

Pressure main line piping 6" and larger shall be Class 200 rubber gasket pipe and 4" and smaller shall be PVC Schedule 40 with solvent welded joints.

Pipe shall be made from an NSF approved Type I, Grade I, PVC compound conforming to ASTM resin specification D1785. All pipe must meet requirements as set forth in Federal Specification PS-22-70, with an appropriate standard dimension (S.D.R.) and be solvent-weld pipe.

6.9.1. Non-Pressure Lateral Line Piping:

Non-pressure buried lateral line piping shall be PVC class 200 with solvent-weld joints.

Pipe shall be made from NSF approved, Type I, Grade II PVC compound conforming to ASTM resin specification D1784.

PVC solvent-weld fittings shall be Schedule, 40, 1-2, II-I NSF approved conforming to ASTM test procedure D2466 for all PVC 4" and smaller.

Solvent cement and primer for PVC solvent-weld pipe and fittings shall be Christie's Red Hot Blue Glue manufacturer.

Rubber Gasket Type AWWA C153 Ductile Iron Fitting shall be used for all PVC pipe 6" and larger under constant pressure

6.9.2. Brass Pipe and Fittings: not used

6.9.3. Galvanized Pipe Fittings: not used

6.9.4. Valves:

6.9.5.1 Gate valves 4" and smaller shall be 200 lb. WOG (water, oil, gas), bronze gate valve featuring screw-in bonnet, nonrising stem and solid wedge disc, threaded ends, and bronze handwheel. Manufacture by Nibco or approved equal.

6.9.5.2 Gate valves 6 inch and larger shall be cast or ductile iron.

6.9.5.3 Quick Coupling Valves shall have a bronze one-piece body designed for working pressure of 150 P.S.I. operable with quick coupler. Valves shall have swing joint and o-ring seals and be installed in valve boxes.

6.9.5.4 Backflow prevention units shall be of size and type indicated on the irrigation drawings. Install backflow prevention units in accordance with irrigation construction details.

6.9.5.5 Swing check valves 2" and smaller shall be 200 pound W.O.G. bronze construction with replaceable composition, neoprene or rubber disc and shall meet or exceed Federal Specification WW-V-51D, Class A, Type IV

6.9.5.6 Anti-drain check valves shall be of heavy duty virgin PVC construction with R.I.P. thread inlet and outlet. Internal parts shall be stainless steel and neoprene. Anti-drain valves shall be field adjustable against drawout from 5 to 40 feet of head. Anti-drain valves shall be similar to the Valcon "ADV" or approved equal.

6.9.6 Electrical Control Valves:

Provide and install one Rainbird control valve box for each electric control valve.

All electric control valves shall be of the same manufacturer and shall feature a manual flow adjustment.

6.9.7 Valve Boxes:

Use 10" x 10-1/4" round box for all gate valves 2 1/2" and smaller, quick couplers and for all wire field splices. Carson Industries #910-12B with black bolt down cover or approved equal. Extension sleeve shall be PVC-6" minimum size. Provide minimum 4" deep clean pea gravel in bottom of all valve boxes (valves to have minimum 2" clearance).

Use 9-1/2" x 16" x 11" rectangular box for all electrical control valves, and 3" and 4" gate valves, Carson Industries 1419-12B with black bolt down cover or approved equal. Provide minimum 4" deep clean pea gravel in bottom of all valve boxes (valves to have minimum 2" clearance).

6.9.8 Sprinkler Heads:

Refer to Master Specification Section 328400, Planting Irrigation.

All sprinkler heads shall be of the same size, manufacturer, model, and deliver the same rate of precipitation. Riser nipples for all sprinkler heads shall be the same size as the riser opening in the sprinkler body.

6.9.9 Automatic Controllers:

Refer to Master Specification Section 328400, Planting Irrigation.

Irrigation controllers shall have inline flow monitors compatible with controllers in use on campus.

Final location of automatic controllers shall be approved by the UH Landscape Project Manager.

6.9.10 Control Wiring:

Connections between the automatic controllers and the electric control valves shall be made with direct burial, insulated copper wire AWG-U.F. 600 volt. Wiring will be a two wire system compatible with Baseline integrated system. Common wires shall be a different color wire for each automatic controller. In no case shall wire size be less than #14.

6.10 FURNISHINGS

6.10.1 General

Campus site furnishings vary in age, condition, style and material. Existing furnishings that are outdated, vandalized or deteriorated shall be replaced as needed with the style indicated in these guidelines until all site furnishings conform to the required standard.

Campus standard site furnishings shall be employed to ensure that all items are of the same family with regard to style, color, and material, and to create a uniformity of expression for exterior use areas of the

campus. Ensure that all items placed on the grounds and in public areas of the campus have a purpose for their placement, and will serve in a convenient but unobtrusive manner.

6.10.2. Furnishing Specifications

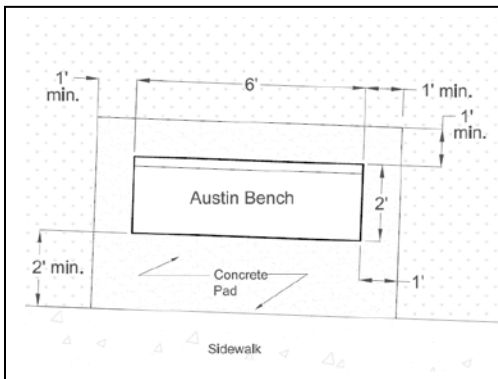
6.10.2.1. Benches

Benches specified for new or replacement installations shall be the Austin bench with cantilevered mounting from Landscape Forms. (See **Figure 6.10.1**) The bench shall be permanently anchored to a concrete base, and placed in a landscape alcove or courtyard-type area adjacent to but off main walkways areas. (See **Figures 6.10.1a and b.**) Benches shall not be placed directly on high-traffic walkways and corridors.

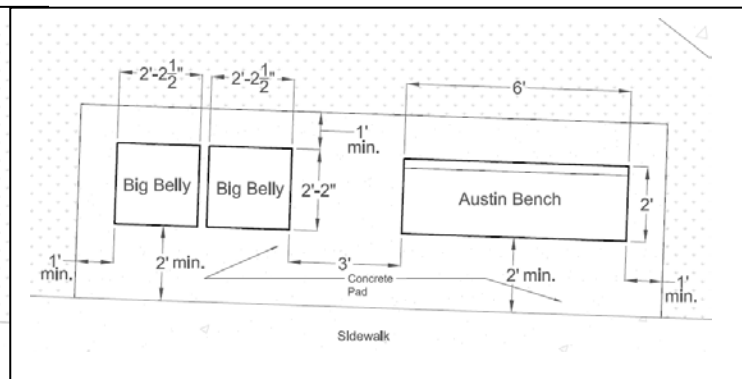
Consideration shall be given for deviations from the norm for benches that are dedicated as memorials or given as gifts to the University.



**FIGURE 6.10.1
BENCHES**



**FIGURE 6.10.1a
BENCH ALCOVE**



**FIGURE 6.10.1b
BENCH/BIG BELLY ALCOVE**



**FIGURE 6.10.2
TABLES AND UMBRELLAS**

6.10.2.2. Tables

Tables shall be Landscape Forms Carousel Table with black powdercoat finish, Equinox Umbrella and Catena solid table tops. (See Figure 6.10.2.)

In groupings of three or more tables, one table shall be wheelchair accessible.

6.10.2.3. Planters

Facilities Maintenance locates planters strategically on campus to control vehicular traffic. Requests for planters must be approved by UH Landscape Project Manager.

6.10.2.4. Trash Receptacles

Trash receptacles specified for new or replacement installations shall be Big Belly Solar Waste and Recycling Containers. Big Belly Containers shall be included in all capital improvement project budgets and site plans. Consult UH Project Manager for further information. **(Figure 6.10.3)**

6.10.2.5. Ash Urns

The University of Houston is a smoke free campus. Ash urns shall not be located on the campus grounds.



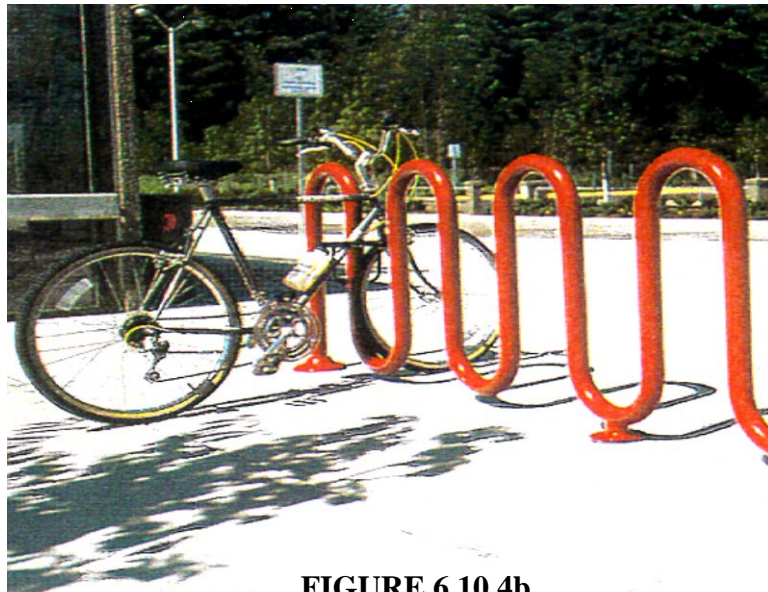
**FIGURE 6.10.3
BIG BELLY RUBBISH/RECYCLING CONTAINERS**

6.10.2.6. Bike Racks

Two styles of bike racks are allowed under these guidelines. The preferred style is the “ring style” (**Figure 6.10.4a**) in stainless steel or in a silver-colored powder-coated finish. The “ribbon style” bike rack (**Figure 6.10.4b**) (steel with a powder-coated finish) may also be used, especially in areas where higher concentrations of bikes are desired. Bike rack areas shall feature a decomposed granite surface; bike racks shall be permanently installed on a concrete base for durability.

Bike racks shall be placed in a location convenient to building entries, away from falling leaf and bird debris, but shall remain as visually unobtrusive as possible. Choice of location shall also take into account security camera coverage. Quantity of ring racks and length of ribbon racks shall be determined by usage requirements for each particular area.

**FIGURE 6.10.4a
RING STYLE BIKE RACK**



**FIGURE 6.10.4b
RIBBON STYLE BIKE RACK**

6.10.2.7. Bollards

Currently there exist many several types and sizes of bollards on campus used to control vehicular traffic on pedestrian walks and in parking lots. Design of bollards shall be considered on a project by project basis, as will the use of illuminated bollards to supplement pedestrian lighting. Existing bollards shall be replaced as the need arises and shall match surrounding bollards, if applicable. All new and replacement bollards must be removable, and should be cylindrical and feature sloped or crowned tops.

6.10.2.8. Sculpture

The Board of Regents of the University of Houston (BOR) approved the acquisition of public art in 1966 in connection with new construction. The acquisitions are to be financed in whole or part by the state’s public art revenue program and shall not exceed 1% of a project’s construction budget.

The System-wide Art Acquisition Committee (SWAAC) shall provide art acquisition services for the administration. Refer to <http://www.uh.edu/af/docs/SWAAC/policy.pdf> for current policies related to public art acquisition.

Sculpture and memorial placement and choice shall consider the size, quality, and color of the piece for proper integration with the overall campus environment. Consideration shall be given for groupings of sculptural elements, to suggest a sculpture garden that is set within a well-landscaped context. Individual sculptures chosen for a group setting should not conflict with each other or create a non-cohesive grouping. (See Figure 6.10.5 for examples.)



**FIGURE 6.10.5
CAMPUS SCULPTURES**

6.11 LIGHTING

6.11.1 General Guideline

Light fixtures shall be chosen for durability, ease of use and maintenance, security, and aesthetic design. Lighting elements shall be exclusively Metal Halide for consistent light color and non-glare properties. Walkway, parking lot, and roadway lighting shall be from overhead, pole-mounted sources. High wattage, low or wall-mounted spotlights that produce glare and create dark shadows shall not be used.

Contractor is cautioned to verify the voltage in use in the area of campus in which new or replacement pedestrian lighting will be installed.

6.11.2. Street and Parking Lights

Light fixtures for new or replacement installations shall be either a single head or double head canister style cylinder with a Metal Halide light element. The color of the pole, pedestal base and top shall be a black powder coat finish. Base mounting details for installation on lawn or planting areas shall be consistent throughout campus and shall be Sonotube formed concrete foundation exposed 6 inches above the finish grade, with the pedestal cap on top, concealing the pole mounting bolts. Installation on paved surfaces shall be nearly identical, with the pedestal cap resting flush with the pavement and with no foundation exposed.

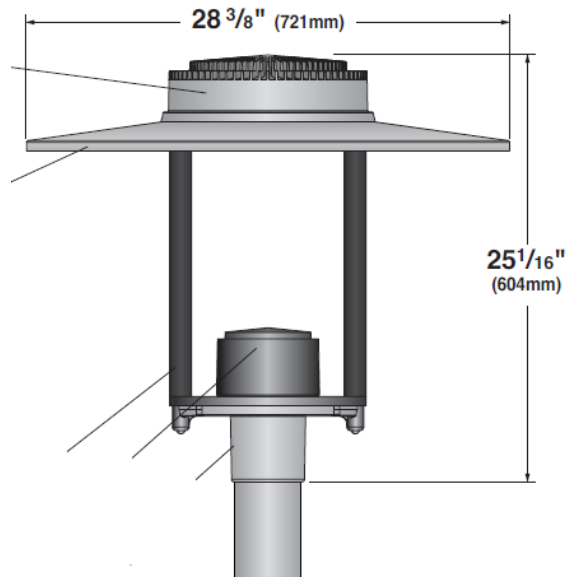
Lighting location shall consider safety and adequate illumination of the surrounding area. Design consideration should also be given of the fixtures as part of the overall landscape: linear alignment, progression, etc. (See Figure 6.11.2)

Refer to **Section 9.9** of the Campus Guidelines and Standards for additional parking lot lighting requirements.

6.11.3 Pedestrian Lights and Light Poles

Light fixtures for new or replacement installations shall be the Saturn Cutoff LED, a single mount luminaire with die-cast aluminum cover. The fixtures should be mounted on a 10' round tapered aluminum pole, with round tapered one piece base cover. The color of the pole and base cover shall be anodized dark bronze. Base mounting details for installation on lawn or planting areas shall be consistent throughout campus and shall be 14" diameter Sonotube formed concrete foundation exposed 5 inches above the finish grade, with slight convex top to shed water. Contractor shall install four leveling nuts between concrete base and pole mounting plate. Hinge location shall not impede pedestrian or vehicular traffic when in down position.

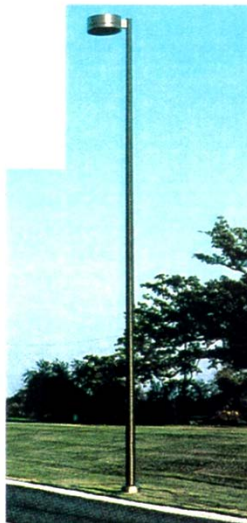
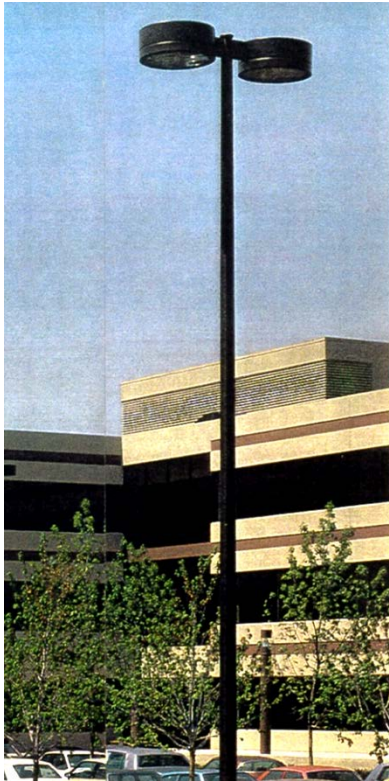
Lighting location shall consider safety, adequate illumination of the surrounding area. Design consideration should also be given of the fixtures as part of the overall landscape: linear alignment, progression, etc. (See Figure 6.11.1)



**FIGURE 6.11.1
PEDESTRIAN LIGHTS**

6.11.4 Lighting Intensities

Refer to **Section 11.2** of the Campus Guidelines and Standards for required light intensity levels.



**FIGURE 6.11.2
STREET AND PARKING
LIGHTS**

6.12 LANDSCAPE PLANS

6.12.1. Requirements

Landscape plans are required for all new major campus building or landscape projects that require site development or modification. Plans must be drawn to scale and identify and show the locations of existing and proposed property lines, easements, roadways, sidewalks, lights, trees, shrubs, groundcovers and other plant materials, natural features, all other landscape elements and planting and construction details. A plant schedule shall be provided which includes the type, installation size, number and placement of materials. Plants are to be identified by both their botanical and common names. Trees that have been designated as to be preserved or relocated by the University shall be identified along with the method of irrigation and protection and the proposed new location.

Landscape plans shall be submitted to FPC for internal distribution and review by Facilities Planning and Construction and by Facilities Maintenance (including the UH Landscape Project Manager). It is the responsibility of FPC to distribute the documents to the appropriate department heads and other appropriate University personnel for review and to verify requirements. FPC is responsible for coordination of all UH comments and requirements. The plans shall not be issued for pricing or construction until the consultant has received notification from the FPC to proceed.

SECTION 7.0

ENVIRONMENTALLY RESPONSIBLE DESIGN GUIDELINES

The Texas State Energy Conservation Office (SECO) has adopted the minimum energy standards for state agencies and institutions of higher education described in:

[http://texreg.sos.state.tx.us/public/readtac\\$ext.TacPage?sl=R&app=9&p_dir=&p_rloc=&p_tloc=&p_ploc=&pg=1&p_tac=&ti=34&pt=1&ch=19&rl=32](http://texreg.sos.state.tx.us/public/readtac$ext.TacPage?sl=R&app=9&p_dir=&p_rloc=&p_tloc=&p_ploc=&pg=1&p_tac=&ti=34&pt=1&ch=19&rl=32)

Environmentally Responsible (“Sustainable”) Design: In addition to other requirements, provide design and construction that minimizes adverse effects on the exterior environment, enhances the quality of the indoor environment, and minimizes consumption of energy, water, construction materials, and other resources.

7.1 LEED Criteria: The University of Houston has adopted many of the USGBC *Leadership in Energy and Environmental Design* (LEED) criteria for sustainable design and, since 2006, has required buildings to be designed to current LEED Silver criteria or greater. Actual certification has not commonly been pursued.

LEED 4 recently has replaced LEED-NC 2009. Like the LEED criteria, UH has also adopted revised EPA and ASHRAE guidelines and continues to improve its metering, recycling, and transparency initiatives.

Until further notice, UH will continue to require new construction to be designed, at a minimum, to LEED-NC 2009 Silver criteria. On an individual project basis, UH FP&C/FS and other Project Team members may make the decision to incorporate sustainable practices from LEED 4.

Selection from the *LEED Project Checklist* of specific credits to achieve is the responsibility of the Consultant unless otherwise indicated.

7.2 Goals: Listed below are some of the sustainable practices that are applicable to UH projects.

- 1) The goals indicated as "Required" must be achieved.
- 2) The goals indicated as "Desirable" will be given high priority.
- 3) The goals indicated as "If possible" must be achieved if the design and site considerations allow.
- 4) The goals indicated "As Specified" have different requirements specified in other Chapters.

7.3 Sitework/Landscaping:

- 1) Minimize footprint: Required.
- 2) Bicycle and cyclist facilities: Required.
- 3) Restoration of degraded site areas: Required
- 4) Minimum surface disturbance: Required. Minimum disturbance limits will be established by UH FP&C Project Manager
- 5) Sediment and erosion control: Required.
- 6) No net increase of storm water runoff: Required.
- 7) Proactive design of storm water management: Required.
- 8) Increased tree canopy: Desirable.
- 9) Use of indigenous/adapted plants: Desirable.
- 10) Reduced irrigation water use/reduced chemical maintenance use: Required.
- 11) Air Quality: The University of Houston is a tobacco-free campus Smoking is prohibited in all areas of campus including construction sites. Required.
- 12) Light pollution reduction: Required
- 13) Integrated pest management plan, including appropriate preventative measures which avert or reduce the occurrence of significant pest problems: Required

7.4 Water Conservation:

- 1) Reduction of potable water use for sewage conveyance: Desirable.
- 2) Reduction of water used by plumbing fixtures, appliances, and equipment through the use of high efficiency plumbing fixtures, appliances, and equipment: Required.
- 3) Air handler condensate recovery: Desirable.

7.5 Energy Conservation:

- 1) Energy efficiency meeting ASHRAE 90.1-2010 and As Specified. Required.
- 2) Improvement of efficiency through basic building commissioning: Required.
- 3) Energy and water consumption measurement and verification systems: Required (see also Section 12.0 of these Design Guidelines, subsections D2020 and D5010)
- 5) No use of HCFC's: Desirable.
- 6) No use of Halon: Required.
- 7) Use of LED lighting: Desirable.

7.6 Conservation of Materials and Resources:

- 1) Recycling rooms, one per floor, and recycling alcoves adjacent to large common spaces (student lounges, multi-purpose rooms, etc.). Required. (see Section 12.0 of these Design Guidelines, subsection C1050, "Recycling Rooms")

- 2) Recycling and/or salvaging of construction waste: Required. (See also Master Specification Section 01 74 19).
- 3) Use of materials containing recycled content: Desirable.
- 4) Use of local/regional materials: Desirable.
- 5) Use of rapidly renewable materials: Desirable.
- 6) Standardization of off-white paint color (See also Section 12.0 of these Design Guidelines, subsection C3010 WALL FINISHES)

7.7 Indoor Environmental Quality:

- 1) Smoking is prohibited in and adjacent to the building: Required.
- 2) Minimum ventilation performance: Required.
- 3) Carbon dioxide monitoring and control: Required in large common spaces (student lounges, multi-purpose rooms, etc.).
- 4) Increased ventilation effectiveness: Desirable.
- 5) Construction procedures that reduce impact on interior air quality during and after construction: Required.
- 6) Use of materials that are low-emitting, non-toxic, and chemically inert: Required.
- 7) Control of sources of indoor pollutants: Required.
- 8) Individual occupant control of environmental systems: If possible.
- 9) Individual occupant control of lighting systems: Desirable.
- 10) Thermal comfort conditions: As specified.
- 11) Provision of daylighting: Desirable.
- 12) Provision of views to outdoors: Desirable.
- 13) Humidity control and monitoring: Required in large common spaces (student lounges, multi-purpose rooms, etc.).

7.8 Substantiation:

- 1) Schematic Design Stage: LEED Checklist annotated to show specific credits to be achieved with brief description of how they will be achieved. If certification is pursued, University will submit application and pay applicable fees.
- 2) Design Development and Construction Documents Stages: LEED Checklist annotated to show status of design related to specific credits to be achieved. If certification is pursued, a comprehensive checklist of certification document specified in LEED Reference Guide annotated to show status of preparation of documentation shall be provided.
- 3) At Project Closeout
 - b) If certification is pursued, Contractor and Architect shall provide University a complete duplicate of certification documentation, including credit application paperwork.
 - a) Contractor shall install certification plaque.

SECTION 8.0

SPACE GUIDELINES AND UTILIZATION GOALS

Space Inventory:

Each institution of the Texas Higher Education Coordinating Board is required to demonstrate to the Board that the condition and quantity of its existing space is adequate to satisfy academic program requirements. Like its higher educational counterparts, the University of Houston collects and maintains data relating to the University of Houston's facilities and provides this information in a standardized format to the THECB and University constituents for internal and external reporting and analysis.

The inventory coding system in-use for this reporting is the UH Facilities Space Reporting Manual (found at: <http://www.uh.edu/plantops/resources/space-reporting-manual/index.php>). Its purpose is to provide a uniform inventory coding procedure for all assignable space in buildings in Texas colleges and universities. The information and procedures presented in this document are compatible with the space inventory coding system in use throughout the United States.

Throughout the year, an ongoing update of the Texas Higher Education Facilities Inventory is conducted by the THECB in cooperation with administrators of all component institutions. The data is received by the Coordinating Board's Division of Finance Campus Planning and Research, edited for internal consistency, and applied to the appropriate institutional file. Each institution receives a printout of its current inventory annually or as often as warranted by significant updates to its file. It is very important for the continued accuracy of each institution's inventory file that the campus representative continually reviews their inventory and make changes as they occur throughout the year. (Please see also <http://www.uh.edu/plantops/resources/space-reporting-manual/index.php>.) The inventory should be viewed as a tool which functions best when it has current data and is used often.

A current facilities inventory provides an excellent and readily useable tool for periodic evaluation both statewide and nationally as well as long-range projection of facilities' needs.

Space Guidelines:

The purpose of the space guidelines and utilization goals is to form a basis for translating elements of an academic or support program into a defined space. The result of applying the various space guidelines represents a "boundary" or "envelope" space requirement for an administrative department and for support space to complement the administrative department's program.

Design and size of specific rooms with an administrative department's generated space "envelope" must be addressed on an individual room basis. The space guidelines should be used in the development of programs for new and remodeled space.

The space guideline tables are merely guidelines in estimating whether or not sufficient space has been provided. They are not intended to be the maximum or minimum amount of space required by a person, an activity, or the administrative department. The space guidelines are not design guidelines but rather estimates of the amount of space by room-use categories that should be satisfactory under normal conditions and circumstances. It is not intended that each person in the University should have the exact amount of space indicated in the space guidelines or that each room would contain exactly the amount of space indicated. Persons may have more or less space than indicated in the space guidelines, depending

upon individual needs. Room space may be larger or smaller than indicated in the space guideline tables, depending upon how the room is used, the equipment that may be required, or the function intended.

The guidelines do not establish entitlements of facilities at each institution. Instead, they establish a reasonable amount of space necessary to accommodate the programs conducted at each institution. The space guidelines do not address the quality of the space or whether existing space is satisfactory for the function involved. These aspects must be addressed separately.

These guidelines are intended to serve as a guide for programming space to satisfy the overall total space requirements of System universities and may not be used necessarily as design guidelines for room sizes for renovation or construction projects. These guidelines address the requirements for satisfying the System's primary educational mission and do not include the requirements for grants and community support. Satisfying temporary shortfalls should be accomplished by leasing or other means short of planning new facilities. Factors used in the computations must be contained in the State System's official database, or verifiable from the institution's records.

The Texas Higher Education Coordinating Board Comprehensive Planning program is designed around a series of computerized data and information accrual systems. The data used in the computations must be contained in the State System's official database, or verifiable from the institution's annual reports.

Space Factors:

The THECB publishes a "five-factor academic space projection model [which] predicts the educational and general (E&G) space required for a public university, technical college, or state college to fulfill its missions of teaching, research, and public service." The model can be found at:

<http://www.thecb.state.tx.us/reports/PDF/1215.PDF?CFID=6019779&CFTOKEN=29199278>

Caution should be exercised in applying space factors and interpreting the results of space use analysis. A clear understanding of what space factor analysis can and cannot do is essential.

The following points should be emphasized in using the space guidelines:

- The validity of applying space factors in capital planning is suspect if space factors have not been consistently applied in the assessment of current space utilization.
- Space factor analysis establishes boundaries or parameters within which the architect, designer or space manager must function. Space factors are not design tools.
- In developing a set of space guidelines and standards, do not feel compelled to automatically reduce everything to numbers. Size of equipment to be housed, expected usage, and the importance of the role these rooms will serve, as determined by the administrative units, may be more appropriate planning parameters.
- Existing databases should be considered when developing specific space factors. For example, if the space inventory doesn't accurately reflect actual space, one must decide to either: 1) modify the inventory, or 2) modify the way the space factor is developed.
- When comparing the results of applied space standards to actual space, consideration must be given to existing conditions. Examples of this would be an existing office of 135 square feet used by a faculty member in which the space guidelines allows 120 square feet or library stack space

that cannot support the shelving capacity listed in the space guidelines because the floors structural load-bearing capacity is inadequate.

It cannot be stressed enough that SPACE GUIDELINES ARE NOT DESIGN STANDARDS. The establishment of a space factor of 220 square feet for a faculty research laboratory does not mean a room 20' x 11'. What the factor does mean is that each faculty member would contribute 220 square feet to the total departmental research space need. Research labs are not being designed – merely boundaries are being established within which design can take place. Individual research areas can range in size from expanded offices to the total departmental research requirement contingent upon the requirements of the program.

It should also be understood that all facets of an academic program cannot be reduced to numerical formulae and that some accommodation must be made for space of a unique nature. All types of university space needs cannot be determined merely by projections from faculty, student and staff data. Art galleries, armories and residential facilities are examples of space types which must be justified programmatically. Size of equipment to be housed, expected usage and the importance of the role these rooms will serve are more appropriate planning parameters.

Building spaces are also documented and areas calculated in CAD format. The Architect on a new construction project shall submit calculations on building assignable and non-assignable spaces with the Design Development Phase. These calculations shall be finalized in the Construction Document Phase submission, at which time the Project gross area shall also be calculated and submitted. Additional information on CAD documentation of building space can be found at:
<http://www.uh.edu/plantops/departments/fpc/cad-standards/index.php>

SECTION 9.0 PARKING LOT AND PAVEMENT DESIGN STANDARDS

- 9.1 INTRODUCTION**
- 9.2 PARKING LOT DESIGN**
- 9.3 HANDICAPPED ACCESSIBLE PARKING**
- 9.4 FLEXIBLE PAVEMENT SYSTEM**
- 9.5 SIDEWALKS AND RAMPS**
- 9.6 SHUTTLE BUS STOPS**
- 9.7 SECURITY**
- 9.8 DRAINAGE**
- 9.9 PARKING LOT LIGHTING**
- 9.10 STRIPING AND MARKING**
- 9.11 SIGNAGE**
- 9.12 PARKING BARRIERS**
- 9.13 LANDSCAPING**
- 9.14 MAINTENANCE AND REPAIR**
- 9.15 UNFORSEEN CIRCUMSTANCES**
- 9.16 WORKING WITH CAMPUS STAFF**
- 9.17 GLOSSARY**

9.1 INTRODUCTION

These standards are to be used when planning any new or refurbished parking lots on the University of Houston Central Campus. These standards are intended as a guide for the design of these lots and are not intended as a complete set of specifications for their construction.



**FIGURE 1.1
OVERVIEW OF PARKING LOT AND LIGHTING**

9.2 PARKING LOT DESIGN

9.2.1 General

The parking lot design objective is to maximize the total number of parking spaces in the space available with the following considerations:

- The parking layout should provide continuous flow of traffic through the lot.
- The design should allow safe movement of pedestrians from parking to buildings.
- The design should allow for appropriate landscaping of the parking areas without conflicting with site lighting.

9.2.2 Pedestrian and Vehicular Circulation

Circulation patterns shall be as obvious and simple as possible. All likely pedestrian routes should be considered in the design phase to eliminate “short cuts” which will eventually damage landscaped areas.

All site facilities and amenities shall be accessible to people with disabilities in accordance with the provisions of the Architectural Barriers Act – State of Texas and the Texas Accessibility Standards (TAS).

Circulation systems shall be designed to avoid conflicts between vehicular, bicycle, and pedestrian traffic. Pedestrian circulation shall take precedence over vehicular circulation.

Where pedestrian circulation crosses vehicular routes, a crosswalk with yellow striping in plastic paint, speed bumps, or signage shall be provided to emphasize the conflict point and improve its visibility and safety.

Circulation routes shall focus upon main entries and exits and also identify secondary access points.

All elements of the site design shall accommodate access requirements of emergency service vehicles. Currently, there are two primary emergency and service vehicles that require access to the various lots:

- Fire Truck – the pumper truck is 47’ long and 8’ wide. The curb-to-curb turning radius is 40’.
- Tow Trucks – the typical tow truck is 21’ long and 7 ½’ wide. The curb-to-curb turning radius with a car in tow is 47’.

9.2.3 Access to Parking Areas

All off-street parking spaces shall be accessible without backing into or otherwise re-entering a public right-of-way, unless it is physically impossible to provide for such access.

When an off-street parking area does not abut a public street, there shall be provided an access drive not less than 24 feet in width for two-way traffic, connecting the off-street parking area with a public street.

9.2.4 Driveway Design

The location of driveways is based upon many factors, including the location of individual property lines and available street frontage, requirements of internal site design, number of vehicles expected to use the driveways, and traffic safety. Generally, the farther from an intersection a driveway can be located, the less it will affect the through traffic and the less delay it will cause to vehicles using the driveway.

Driveway approaches shall be constructed so as not to interfere with pedestrian crosswalks.

Driveways shall be constructed a minimum of three (3) feet from any obstruction such as a street light or utility pole, fire hydrant, traffic signal controller, telephone junction box, etc.

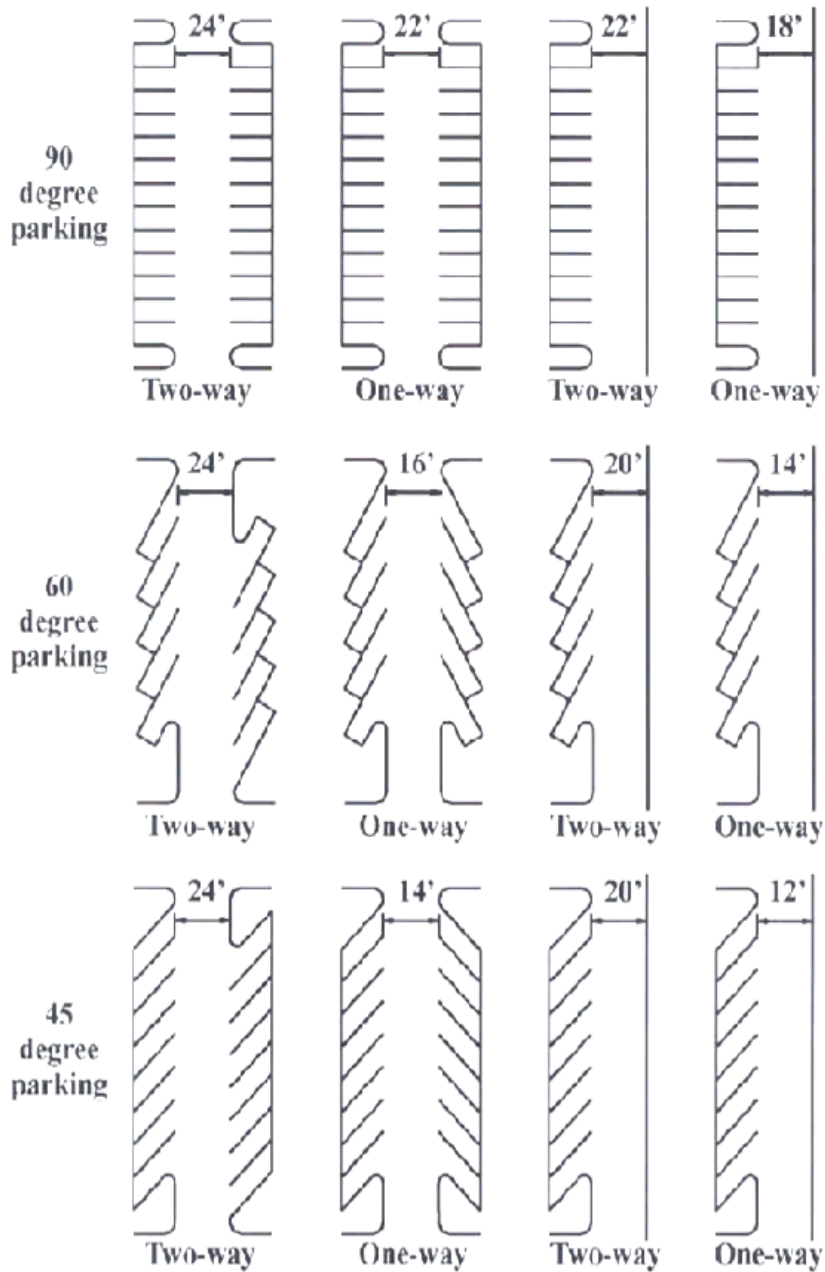
Driveway entrances shall be designed to accommodate all vehicle types having occasion to enter the lot, including delivery and service vehicles.



**FIGURE 9.2.2
FINISHING CONCRETE AT WHEELER STREET DRIVEWAY**

9.2.5 Parking Lot Layout

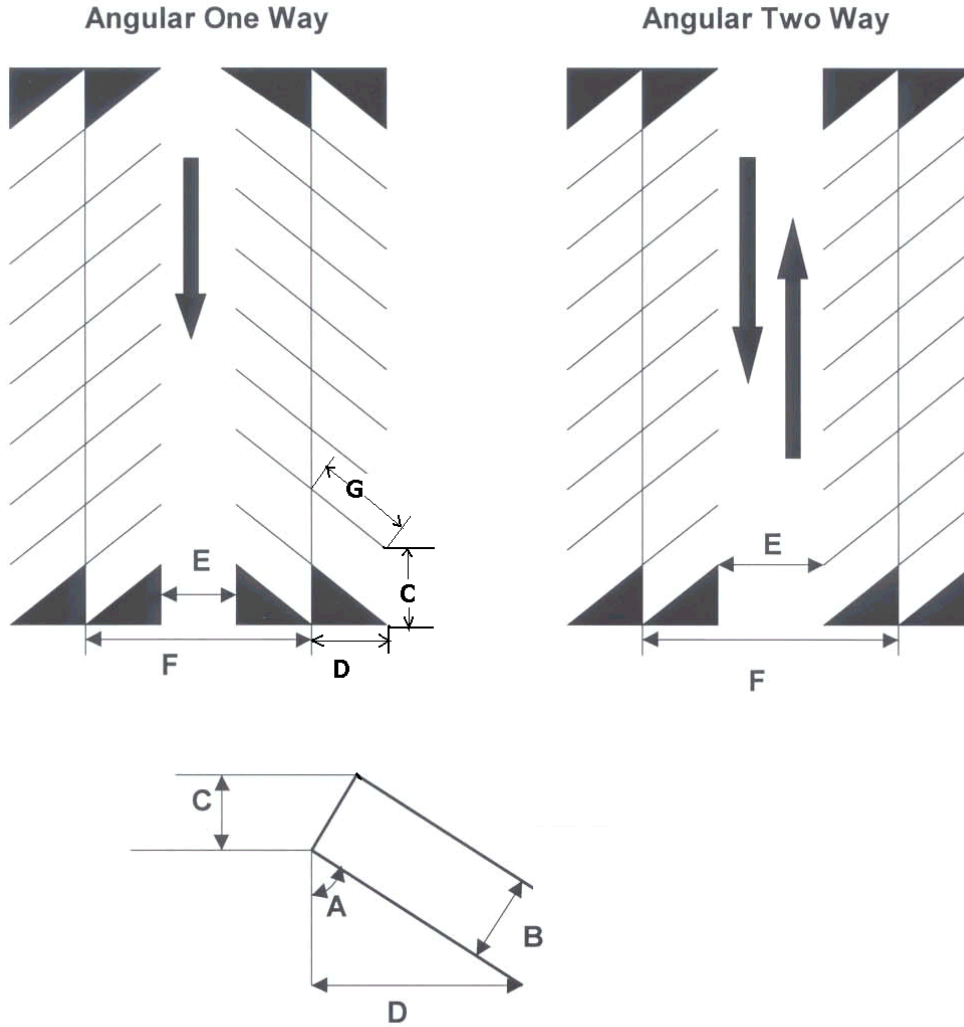
Drives that do not allow parking within the driveway right-of-way are 24' for two-way traffic and 12' for one-way traffic. For drives serving thirty (30) or fewer vehicles and where parking is not provided on either side, the width for two-way drives can be reduced to twenty-two (22) feet. Aisle widths are dependent upon traffic flow (one or two-way), angle of parking and whether or not parking is on both sides of the aisle. See Figure 9.2.3 for examples.



**FIGURE 9.2.3
PARKING LOT AISLE WIDTHS**

9.2.6 Dimensions

All parking spaces, exclusive of access drives or aisles, shall consist of a rectangular area not less than eight and one-half (8½) feet wide by eighteen (18) feet in length except that parallel parking stalls shall be ten (10) feet by twenty (20) feet. For parking dimensions refer to Figure 9.2.4 and Table 2 below:



**FIGURE 9.2.4
ACCEPTIBLE PARKING DESIGNS**

Angle Parking Angle	Dimensions				One Way Traffic		Two Way Traffic	
	Stall Width (ft)	Curb Length (ft)	Stall Depth (ft)	Stripe Length (ft)	Aisle Width (ft)	Section Width (ft)	Aisle Width (ft)	Section Width (ft)
A	B	C	D	G	E	F	E	F
30°	8.5	17	16.4	32.7	12	44.7	24	56.7
45°	8.5	12	18.7	26.5	14	51.4	24	61.4
60°	8.5	9.8	19.8	22.9	16	55.6	24	63.6
90°	8.5	8.5	18	18	22	58	24	60

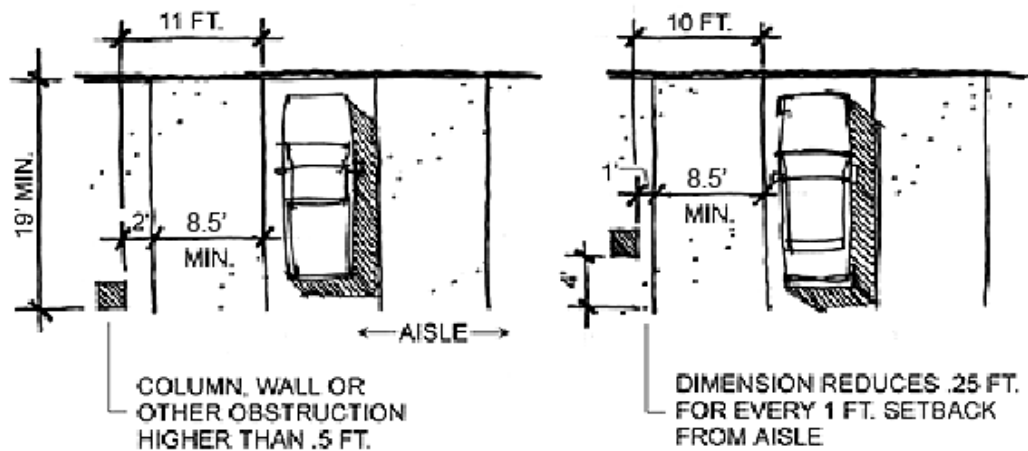
**TABLE 2
MINIMAL STANDARDS FOR PARKING ON BOTH SIDES OF AISLE**



**FIGURE 9.2.5
PERPENDICULAR (90°) PARKING SPACES**

The following exceptions to the minimum standards apply:

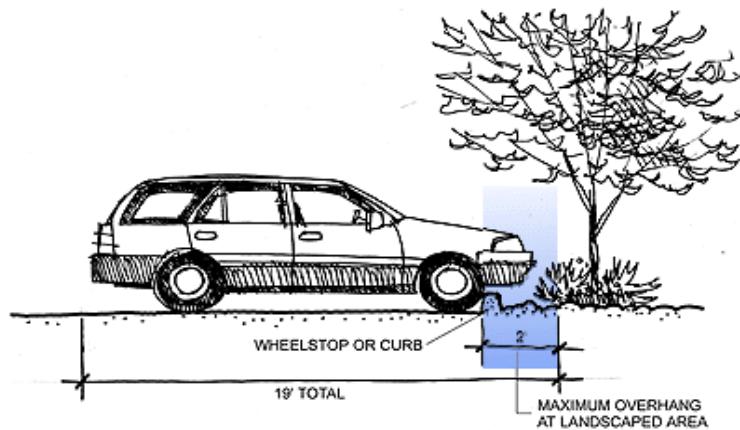
Spaces Near Obstructions. When the side of a parking space adjoins a wall, column, or other obstruction that is taller than 0.5 feet, the width of the parking space shall be increased by 2 feet on the obstructed side, provided that the increase may be reduced by 3 inches for each 12 inches of unobstructed distance from the edge of a required aisle, measured parallel to the depth of the parking space. (See Figure 9.2.6)



Spaces Near Obstructions

FIGURE 9.2.6

Planter Overhangs. When a parking space abuts a landscape island or planter, the front 2 feet of the required parking space length may overhang the planter, provided that wheel stops or curbing is provided. (See Figure 9.2.7)



Reduction for Planter Overhangs

FIGURE 9.2.7

9.2.7 Curbs

All new parking lots should be constructed with perimeter curbs wherever feasible. These curbs should be constructed of reinforced concrete and should be either monolithic or lay down depending upon the location and function of the curb. See Figure 9.2.8 for an example of a 6” monolithic concrete curb with gutter.



FIGURE 9.2.8
MONOLITHIC CURB ALONG PERIMETER OF PARKING LOT

9.2.8 Grading

Abrupt or unnatural appearing grading design is not acceptable. Grading on new project sites shall blend with the contours of adjacent properties. Proposed cut and fill slopes shall be rounded off both horizontally and vertically.

When designing a grading plan, balancing the cut and fill is highly encouraged when it does not result in further damage to the natural topography. Where the site plan results in substantial off-haul or infill, a mitigation plan may be required to address the impacts and clean-up of off-site construction activities.

To prevent soil compaction and significant root damage, grading under the drip line of trees is not acceptable.

9.3 HANDICAPPED ACCESSIBLE PARKING

9.3.1 General

Accessible parking for disabled persons must conform to the details and guidelines found in the Architectural Barriers Act – State of Texas and in the Texas Accessibility Standards (TAS).

9.3.2 Accessible Parking Space Location

Accessible parking must be conveniently located near a main accessible building entrance, via the shortest accessible route. For buildings with multiple accessible entrances with adjacent parking, accessible parking spaces should be dispersed and located closest to the accessible entrances.

Accessible parking spaces may be clustered in one or more lots if equivalent or greater accessibility is provided in terms of distance from the accessible entrance, impact of parking fees and convenience.

9.3.3 Route

An accessible route must always be provided from the accessible parking to the accessible entrance. An accessible route never has curbs or stairs, must be at least three (3) feet wide, and has a firm, stable, slip-resistant surface. The slope along the accessible route should not be greater than 1:12 in the direction of travel.

Parked vehicle overhangs shall not reduce the clear width of an accessible route.

9.3.4 Layout

Accessible parking spaces must be 8' wide with a 5' wide adjacent access aisle. The first space and 1 in every 6 additional spaces should be van accessible. Van accessible spaces require an 11' wide space with a 5' wide adjacent access aisle (preferred). Alternatively, van accessible spaces may be 8' wide with an 8' wide access aisle. Two accessible parking spaces may share a common access aisle.



FIGURE 9.3.1
SHARED HANDICAPPED ACCESS AISLES LEADING TO RAMP

9.3.5 Marking and Signage

Signs displaying the international access symbol should be provided at each accessible parking space. The signs should be displayed on fixed mountings in an area where they are not hidden from view. Pavement marking symbols must be used to supplement signs. Spaces intended for van parking should be marked accordingly. Refer to the Americans With Disabilities Act Accessibility Guidelines (ADAAG) for detailed requirements for marking and signs. See Section 9.11 for Sign and Pole details.

“Minimum fine” signage shall be mounted below access symbol signage.



FIGURE 9.3.3
“\$250 MINIMUM FINE” BELOW PARKING SIGN

9.3.6 Number of Spaces

Parking stalls for disabled persons should be provided in each parking lot in accordance with the following table:

Number of Spaces for Disabled Persons	
Total Spaces in Lot	Required Accessible Spaces
1-25	1
26-50	2
51-75	3
76-100	4
101-150	5
151-200	6
201-300	7
301-400	8
401-500	9
501-1000	2%
1000+	20, plus 1 for each 100, or fraction thereof, over 1000

9.3.7 Parking Lot Access Ramps

Ramps must be provided at curbs or other raised barriers to provide access to the accessible routes leading from the parking lot. Ramps must be 48" wide (exceeds 36" code minimum) and ramp grades cannot exceed 1:12. Handrails must conform to the latest requirements in the Architectural Barriers Act.



**FIGURE 9.3.4
ADA RAMP AND HANDRAILS**

9.4 PAVEMENT SYSTEM

9.4.1 General

In recent years the University of Houston has constructed more concrete parking lots than asphalt parking lots. As the construction cost between the two systems diminishes, the University has elected to take advantage of concrete paving's greater durability and lower heat island effect.

Maintenance of existing asphalt lots is predominantly crack repair, seal coating on a regular basis, localized area patches to address potholes and ruts on an as needed basis, and a mid-life asphalt overlay. See 9.14 for further information.

NOTE: Upon completion of all University of Houston asphalt parking lot projects, the contractor is required to submit Material Safety Data Sheets (MSDS) for asphaltic materials used in the project, as well as the amount used (including added kerosene or other cutting agents).

9.4.2 Usage

Since parking lot traffic will consist primarily of passenger vehicles and possibly light construction vehicles from time to time, the Traffic Design Index is DI-1 – Light Traffic (Few vehicles heavier than passenger cars; No regular use by heavily loaded two axle trucks or larger vehicles).

9.4.3 Pavement Standards—Refer to Master Construction Specification Section 32

9.5 SIDEWALKS AND RAMPS

9.5.1 Sidewalks (See also Master Construction Specification 321313 -- CONCRETE PAVING FOR PEDESTRIAN AREAS)

Sidewalks should be constructed according to the following criteria:

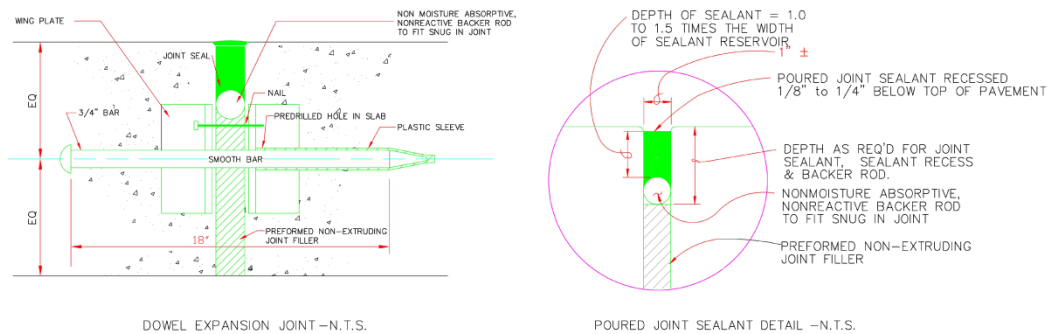
Sidewalks shall be 6'-0" wide, 5" thick, with ¼" per foot transverse slope, and shall be reinforced with #3 bar spacing at 14" OC in the interior and #4 bars along the edges. Rebar shall be supported on support chairs. Prior to installing, existing substrate shall be cleaned of all vegetation and proof-rolled. Sidewalk subbase shall be graded using a compacted fine-graded soil with PI of between 13 and 20. Walks designated as traffic-bearing must be at least 6" thick.

The sidewalk should extend above the adjacent finished grade 2".

Sidewalk curves should be formed true and smooth. Contractor should secure approval of formwork from the Project Manager prior to placing concrete for each pour.

New sidewalks should be doweled into existing sidewalks with 12" long smooth No. 4 dowels, with one end greased and thimble, spaced at 12" o.c., with a ½" expansion joint.

Doweled 1" expansion joints in the sidewalk should be located at every 42 feet. Dowels should be 18" long smooth No. 4 dowels, spaced at 12" o.c., with one end greased and thimble.



Joint dowel bars for expansion joints should be Grade 60 plain steel bars, as specified under ASTM A615. Cut bars true to length, with the ends square and free of burrs.

The 1" expansion joints for sidewalks should be formed as follows:

- The joint filler should be polyethelene closed-cell expansion joint filler material, Sonoflex F by Sonneborn, or equal.
- Install to a depth of 1" below the walk surface.
- Prior to applying joint sealant, clean the joint and prime joint with primer. Do not prime expansion joint filler material.
- Apply one-component polyurethane self-leveling sealant, conforming to ASTM C920, Type S, Grade P, Class 25, Use T or M, in the upper 1/2" depth of the joint, over the joint filler material.. Alternatively, Install xpansion and Isolation-Joint-Filler Strips: ASTM D 1751, asphalt-saturated cellulosic fiber or ASTM D 1752, cork or self-expanding cork

Control (contraction) joints in the sidewalk should be cut through 1/4 of the slab thickness and have both sides edged and tooled. The layout of the control joints should be indicated in the drawings or described in the project specifications.

All edges and joints should be rounded to a minimum of 1/4" radius with an approved tool. Horizontal surface of edging tool should not exceed 2" in width and should not depress into sidewalk more than 1/16".

The Contractor should secure approval of walk finish from a UH project representative at the completion of no more than the first 300 sq. ft. of walk construction.

All sidewalks should be cured with liquid-type membrane-forming curing compound complying with ASTM C309, Type I, Class A or B. Curing compound should be applied in strict accordance with manufacturer's recommendations.

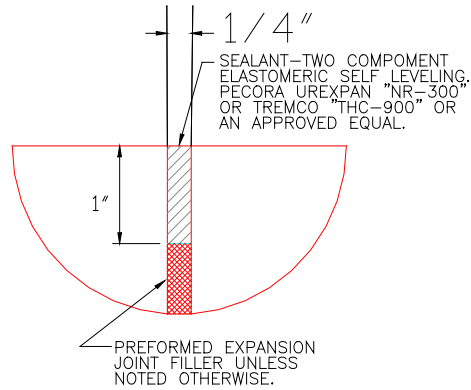


FIGURE 9.5.2
SEALED EDGE ISOLATION JOINT

9.5.2 Accessible Routes

Provide at least one accessible route within the boundary of the parking lot from public transportation stops, handicapped accessible parking and accessible passenger loading zones, and public streets or sidewalks to the accessible building entrance they serve.

Location: Accessible routes shall be located so that pedestrians are not required to wheel or walk behind parked vehicles (except the one they operate or in which they are a passenger) or in traffic lanes.

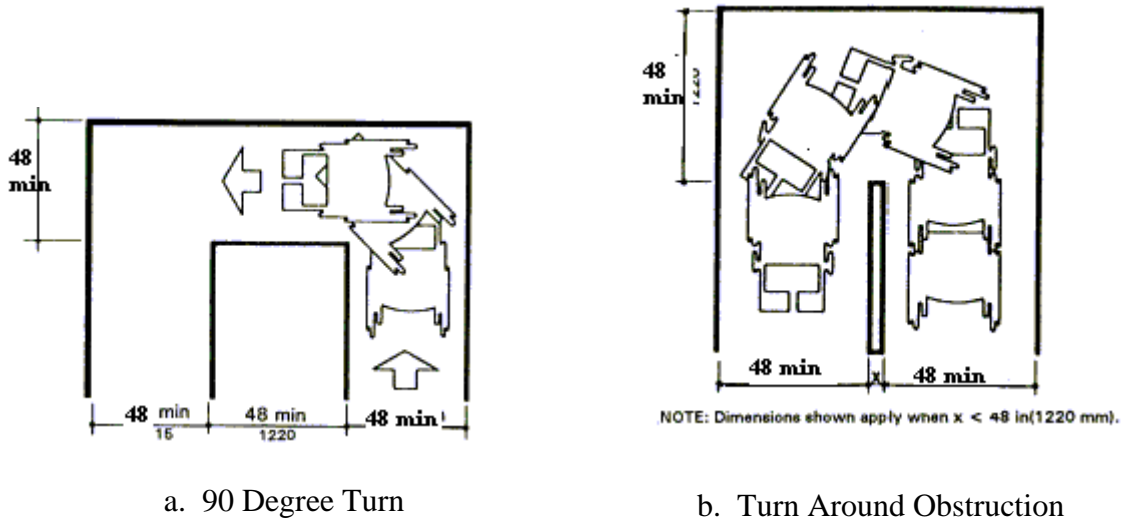
Width: The minimum clear width of an accessible route shall be 48". If a person in a wheelchair must make a turn around an obstruction, the minimum clear width of the accessible route shall be as shown in Fig. 9.5.3.

Passing Space: If an accessible route has less than 60" clear width, then passing spaces at least 60" by 60" shall be located at reasonable intervals not to exceed 200 ft. A T-intersection of two walkways is an acceptable passing place.

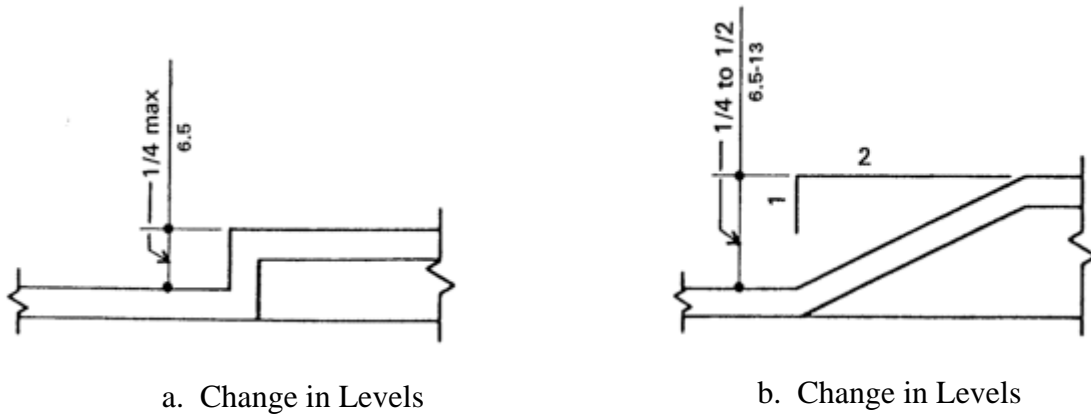
Surface Textures: Ground surfaces along accessible routes including walks, ramps, and curb ramps, shall be stable, firm, and slip-resistant. Sidewalks and walkways should be constructed of concrete or similar materials. Soft or loose materials such as sand, gravel, bark, mulch or wood chips are not suitable.

Slope: An accessible route with a running slope greater than 1:20 is a ramp and shall comply with section 5.4. Nowhere shall the cross slope of an accessible route exceed 1:50.

Change in Levels: Changes in levels along an accessible route up to 1/4" may be vertical and without edge treatment (See Fig. 9.5.4a). Changes in levels between 1/4" and 1/2" shall be beveled with a slope no greater than 1:2 (See Fig. 9.5.4b). If an accessible route has changes in level greater than 1/2", then a curb ramp or a ramp shall be provided that complies with the current Texas Accessibility Standards (TAS). An accessible route does not include stairs, steps, or escalators.

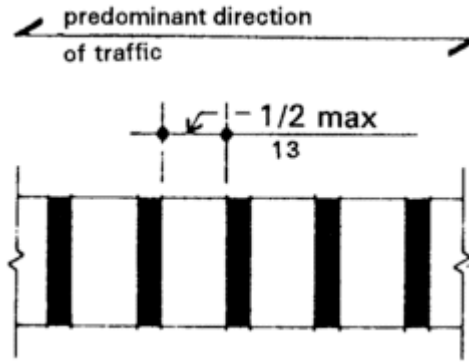


**FIGURE 9.5.3
 ACCESSIBLE ROUTE**

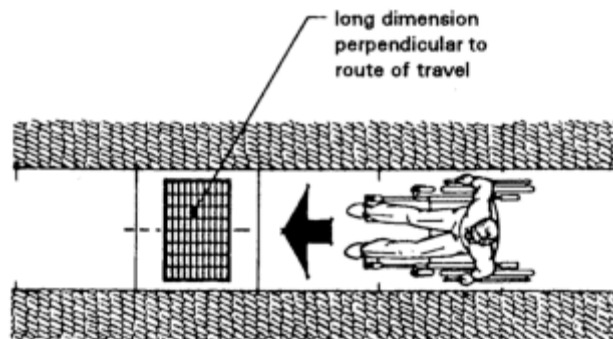


**FIGURE 9.5.4
 ACCESSIBLE ROUTE**

Gratings: If gratings are located in walking surfaces *or along accessible routes*, then they shall have spaces no greater than 1/2" wide in one direction (See Fig. 9.5.5a). If gratings have elongated openings, then they shall be placed so that the long dimension is perpendicular to the dominant direction of travel (See Fig. 9.5.5b).



**FIGURE 9.5.5a
GRATINGS**

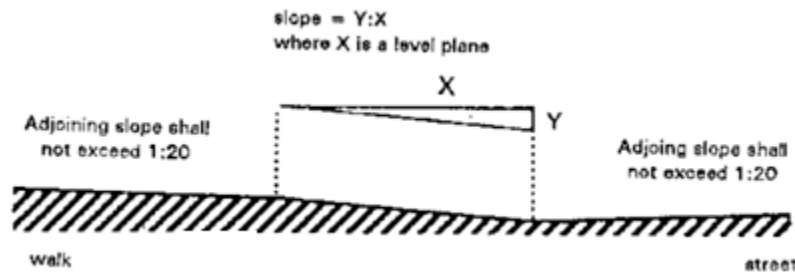


**FIGURE 9.5.5b
GRATING ORIENTATION**

9.5.3 Curb Ramps

Curb ramps must conform to the following standards:

Slope: Slopes of curb ramps shall comply with section 9.5.4. The slope shall be measured as shown in Fig. 9.5.6. Transitions from ramps to walks, gutters, or streets shall be flush and free of abrupt changes. Maximum slopes of adjoining gutters, road surface immediately adjacent to the curb ramp, or accessible route shall not exceed 1:20.

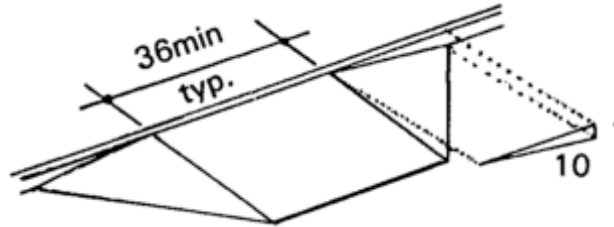


**FIGURE 9.5.6
MEASUREMENT OF CURB RAMP SLOPES**

Width: The minimum width of a curb ramp shall be 36", exclusive of flared sides.

Surface: Surfaces of curb ramps shall be stable, firm and slip-resistant with a broom finish. Transitional textures at base of ramp vary with location. Refer to current TAS 2012 guidelines for current truncated dome requirements.

Built-up Curb Ramps: Built-up curb ramps shall be located so that they do not project into vehicular traffic lanes or into spaces that would interfere with persons entering or exiting parked or standing vehicles (See Fig. 9.5.7).



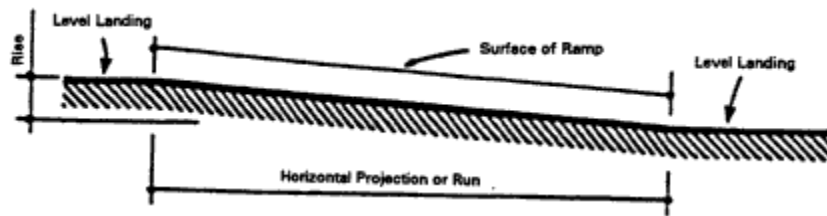
**FIGURE 9.5.7
BUILT-UP CURB RAMP**

9.5.4 Ramps

Please note that in December 2015, the US Department of Justice released an ADA Compliance Brief affecting handicapped parking striping and parking lot ramp configuration. Please see http://www.ada.gov/restriping_parking/restriping2015.pdf for details.

In accordance with the Texas Architectural Barriers Act any part of an accessible route with a slope greater than 1:20 shall be considered a ramp. Ramps shall be constructed according to the following criteria and shall conform to all current TAS requirements.

Slope and Rise: The least possible slope shall be used for any ramp. The maximum slope of a ramp in new construction shall be 1:12. The maximum rise for any run shall be 30" (See Fig. 9.5.8).



Slope	Maximum Rise		Maximum Horizontal Projection	
	in	mm	ft	m
1:12 to < 1:16	30	760	30	9
1:16 to < 1:20	30	760	40	12

**FIGURE 9.5.8
COMPONENTS OF A SINGLE RAMP
RUN AND SAMPLE RAMP DIMENSIONS**

Clear Width: The minimum clear width of a ramp 30 feet or less in length shall be 44”.

Landings: Ramps shall have level landings at bottom and top of each ramp and each ramp run. Landings shall have the following features:

- It shall be at least as wide as the width of the ramp run leading to it.
- The landing length shall be a minimum of 60” clear.
- If ramps change direction at landings, the minimum landing size shall be 60” by 60”.

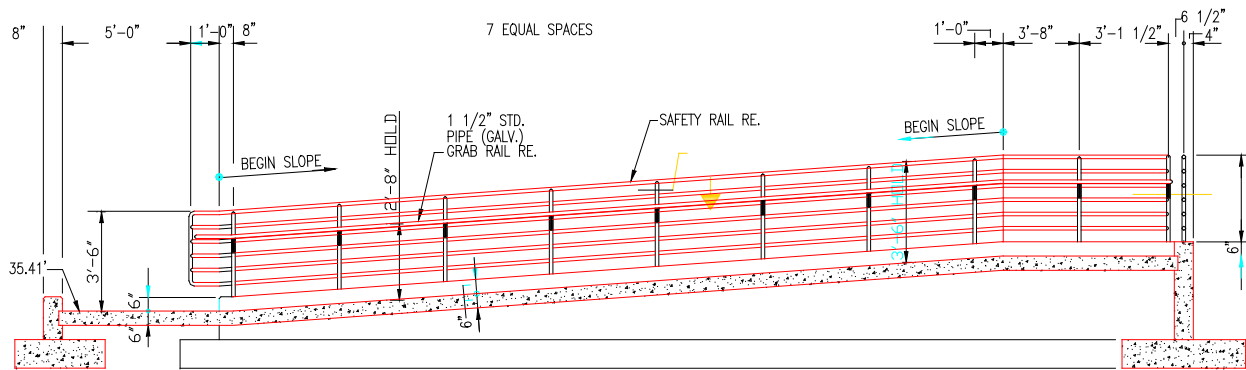
Handrails: If a ramp run has a rise greater than 6” or a horizontal projection greater than 72”, then it shall have handrails on both sides. Handrails are not required on curb ramps. Handrails shall have the following features:

- Handrails shall be provided along both sides of ramp segments. The inside handrail on switchback or dogleg ramps shall always be continuous. Ramps in excess of 176” in width shall have intermediate handrails spaced a maximum of 176” on center.
- If handrails are not continuous, they shall extend at least 12” beyond the top and bottom of the ramp segment and shall be parallel with the floor or ground surface (See Fig. 9.5.7).
- The *nominal* diameter or width of the gripping surfaces of a handrail shall be 1-1/2”, or the shape shall provide an equivalent gripping surface.
- If handrails are mounted adjacent to a wall, the space between the wall and the handrail shall be 1-1/2”. Handrails may be located in a recess if the recess is a maximum of 3” deep and extends at least 18” above the top of the rail.
- Handrails shall be of low maintenance materials such as galvanized metal or factory finished aluminum; or shall be painted with epoxy paint. Typical handrail color is black.

Cross Slope and Surfaces: The cross slope of ramp surfaces shall be no greater than 1:50. Ramp surfaces shall comply with Section 9.5.2.

Edge Protection: Ramps and landings with drop-offs shall have curbs, walls, railings, or projecting surfaces that prevent people from slipping off the ramp. Curbs shall be a minimum of 2” high.

Outdoor Conditions: Ramps approaches shall be designed so that water will not accumulate on walking surfaces.



**FIGURE 9.5.9
ADA RAMP AND HANDRAILS**

9.6 SHUTTLE BUS STOPS

9.6.1 General

The University of Houston will designate locations for Shuttle Bus Stops requiring a concrete slab for a shelter. These locations will be clearly drawn on the parking lot construction drawings.

9.6.2 Criteria

Shuttle Bus Shelter pads will be constructed of 6" poured concrete (3500 psi) 18' x 24' in size unless otherwise shown on the individual shelter plans. Concrete slabs will be reinforced with #3 bar spaced a maximum of 18" apart in both directions. Concrete surface shall be broom finished and feature 2% slope to rear of pad for drainage.

Where Shuttle Bus Shelter pads are above pavement height, a curb ramp conforming to Section 5.3 will be constructed to allow handicapped access to or from the pad.

9.7 SECURITY

9.7.1 General

Each parking lot presents its own particular problems based on physical layout, terrain, and security requirements. Campus parking lot security can be enhanced through a combination of lighting, surveillance and response. These actions will improve security, deter crime, reduce potential liability and make staff and students feel safer.



FIGURE 9.6.1
FRAMING AND REINFORCING FOR CONCRETE PAD

9.7.2 Security Lighting (see also SECTION 11.0 --LIGHTING DESIGN GUIDELINES)

Security lighting is used to increase effectiveness of campus police forces by increasing the visual range of the police during periods of darkness or by increased illumination of an area where natural light does not reach or is insufficient. Lighting also has value as a deterrent to potential individuals looking for an opportunity to commit crime. Normally security lighting requires less intensity than working areas. Police must be able to identify badges, people at gates, observe activity, inspect vehicles, observe illegal entry attempts, detect intruders in the protected area, and observe unusual or suspicious circumstances. The goal of direct illumination is to provide the specified intensity throughout the area for support of campus police, provide good visibility for faculty, students or staff and have a minimum of glare. Lighting must follow the provisions of Section 9 of this manual.

As a rule of thumb, illumination levels at entrances, exits, loading zones and collector lanes of parking areas should not be less than twice the illumination of the adjacent parking area or the adjoining street whichever is greater.

9.7.3 Layout

Normally students and staff who arrive early also leave early, leaving late arrivals the less secure (further away from buildings and traffic flow) parking spaces. Since these late arrivals also are usually the last to leave, they are also the most vulnerable to crime. By rerouting incoming and outgoing traffic through the parking lot to pass by the more remote areas, natural surveillance is increased and criminal opportunity is reduced.

Parking perpendicular to the line of sight reduces the criminal value of hiding between cars waiting for potential victims. Walking corridors between cars at strategic locations also concentrates foot traffic and increases natural surveillance by students and staff.

9.7.4 Emergency Call Stations

Surveillance without potential response provides little increase in system trust by customers. Emergency Call Stations that can be used to call security forces or police to an emergency situation should be provided at multiple convenient locations in each lot. Availability of these call stations for use by customers observing a crime in progress or by victims who are threatened provides a considerable increase in comfort level for staff and students. These systems provide immediate voice contact (with security forces), alarm (to attract attention) and light signal (quick location of trouble spot).

The UH emergency call station system consists of a one button hands-free direct dial communications unit. There are two different types of units one for wall mounting and one standalone exterior mounting. The communications units are manufactured by Code Blue (www.codeblue.com). For current specifications, please see Master Construction Specification Section 28 26 00 - Electronic Personal Protection Systems.



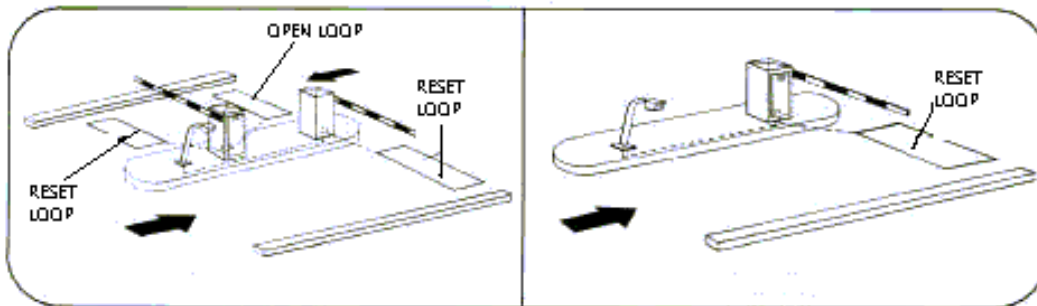
**FIGURE 9.7.1
CODE BLUE EMERGENCY
CALL BOX**

9.7.5 Barrier Gates

Barrier gates are a means of restricting use of parking spaces to those individuals with pre-approved permission to park in a specific lot. Gates can be a two-way gate system or a single card gate with a separate controlled egress. (See Figures 9.7.2 and 9.7.3)



**FIGURE 9.7.2
BARRIER GATE**



a. Two Way Gate System

b. Card Gate

**FIGURE 9.7.3
PARKING LOT GATE SYSTEMS**

9.8. DRAINAGE

9.8.1 General

All parking lots shall be designed to develop proper site drainage, directed at the disposal of all storm water accumulated on the site. Parking lots constructed on UH campuses and other facility sites which contain an area of 2,500 square feet or more; and which are located within 150 feet of an existing storm sewer or other drainage way, including an open channel or creek, should be designed to direct storm water runoff into such storm sewers or drainage ways. The parking lot should be graded and surfaced such that storm water runoff from the site is collected on the site

by a parking lot drainage system and carried to the storm sewer system, and not allowed to discharge through the driveway entrances and exits onto the public way. Proposed finished elevations of the parking lot must be indicated on appropriate plans. The site drainage design must not restrict flows that could occur during a 100-year flood condition.

9.8.2 Proper Drainage

Laboratory testing and practical experience have demonstrated the dramatic reduction in the ability of a soil to resist stresses in the presence of excess moisture. For this reason, one of the most important functions of a pavement is to provide a seal over the underlying soil or sub grade.

Although the pavement itself absorbs much of the traffic-induced stress, invariably some of this pressure is ultimately transmitted to the soil foundation. If there is excess moisture in this soil, it may be unable to resist the applied loads. The load will eventually exceed that which the pavement can tolerate, and a local failure will result.

Excess moisture can be prevented by proper drainage. Properly designed inlets and culverts should efficiently remove storm water from the parking lot surface. Where necessary, subsurface drains should be used to collect and dispose of groundwater before it can reach the sub grade.

Evidence of poor drainage, which includes ponding (bird baths) or standing water that does drain from the surface of a parking lot, is an unacceptable consequence of poor parking lot construction. The University of Houston will require that the paving contractor rectify any ponding susceptible areas at their cost and at a schedule and method acceptable to the University during the first year following handover of the parking lot to the University.

9.8.3 Pipes

Refer to Master Construction Specification Division 33. All drainage pipes shall be constructed of Reinforced Concrete Pipe (RCP). Pipes shall be designed for free flow and a minimum velocity of 3.0 fps at peak design flow. Wherever possible underground utilities should parallel the roadway centerline.

9.8.4 Storm Drain Manholes, Junction Boxes and Cleanouts

Manholes are required at:

- Any change in horizontal or vertical alignment of underground drainage pipe. Minor horizontal curvature in pipe less than 15 degrees may be allowed, (without manholes or cleanouts), depending on pipe size, street alignment, degree of curvature and reason. Maximum joint deflection shall be per manufacturer's recommendation.
- All connections.
- All changes in pipe size.
- At least every 500 feet.

Standard catch basins, junction boxes, or cleanouts may be used in place of manholes for pipe no larger than 18 inches in diameter and with a depth less than 4.0 feet.

Avoid placing manholes within a parking space. Wherever possible manholes should be located behind the curb or in drive lane.

9.8.5 Inlets and Catch Basins

Inlets and catch basins are required at:

- All low spots and shall be connected to a storm drainage facility.
- At least every 500 feet of gutter length.



FIGURE 9.8.2
MONOLITHIC CURB, INLET AND CATCH BASIN

9.8.6 Open Channels

All existing ditches and other open channels feeding a pipe with a diameter greater than 36 inches shall remain open channel except at road crossings.

Where possible, ditches shall be located along or adjacent to lot lines.

For reasons of maintenance and safety, bank slopes shall be 4:1 or flatter.

The maximum allowable design velocity is 7 fps.

The minimum allowable design velocity is 2 fps. The installation of a concrete lined low-flow channel may be required to achieve minimum velocity.

The normal maximum depth for an open ditch is 4 feet outside of road rights-of-way and 2 feet adjacent to the roadways.

9.9 LIGHTING (see also SECTION 11.0 --LIGHTING DESIGN GUIDELINES)

9.9.1 Purpose

Parking lot lighting is vital for traffic safety; for protection against assault, theft and vandalism; for convenience; and for comfort to the user. Lighting on parking lots at the University of Houston Central Campus are to be designed to provide the minimum lighting necessary to ensure adequate vision and comfort while being arranged so as not to cause visual interference on public thoroughfares or encroach on the visual privacy of adjacent building occupants.

9.9.2 Criteria

Lighting systems are to be designed to conform with Illuminating Engineering Society of North America (IESNA) requirements, to the International Dark-Sky Association (IDA) recommendations, and to the following criteria:

General: All UH parking lot lighting will utilize a standard luminaire and pole height unless the Director of Facilities Planning and Construction directs otherwise.

Illumination Level within the Parking Lots: Illumination levels at any point across the parking lot must not be greater than 6.0 foot-candles in the horizontal plane, and must not exceed 0.5 vertical foot-candles. All points across the interior of the parking lot must have an illumination level greater than 3.0 foot-candles. Illumination in low traffic areas must not fall below the 2.5 foot-candles level.

Illumination Level Beyond Parking Lot Perimeter: Illumination attributable to a parking lot lighting system should not exceed 0.50 horizontal foot-candles beyond the perimeter of the parking lot.

Illumination Level at High Traffic Areas: Illumination levels at entrances, exits, loading zones and collector lanes of parking areas should be greater than twice the illumination of the adjacent parking area or the adjoining street, whichever is greater.

Uniformity Ratio: The illumination uniformity ratio should not exceed 3:1, average to minimum, or 4:1 maximum to minimum. The use of unnecessarily high wattage lights can actually lead to a less secure environment by creating dark pockets just outside the range of the lights.

Glare Control: Lighting should be designed to protect against glare onto public rights-of-way that could impair the vision of motorists and adversely impact adjoining properties. Lighting adjacent to buildings and/or residential districts must be arranged so that the luminaires have a sharp cutoff at no greater than 78 degrees vertical angle above nadir. Not more than five (5) percent of the total lamp lumens can project above 78 degrees vertical.

Spillover: In the ideal case, all exterior light would be shielded from adjacent properties by existing vegetation, thick evergreen vegetated buffers, berms, walls or fences, and/or the use of directional lighting, lighting shields, special fixtures, timing devices, appropriate light densities, luminaires, and mountings at established heights. A design objective for all UH parking lots is for outdoor lighting to be designed and located such that the maximum illumination measured in foot-candles at the property line shall not exceed 0.5 onto adjacent residential sites and 1.0 onto adjacent commercial sites and public rights-of-way.

Orientation: The intent of UH parking lot lighting is to minimize or eliminate light directed upward. Light emitted at angles of 80 degrees higher (where straight down is 0 degrees) fails to produce useful illumination on horizontal surfaces in open areas. At these high angles light produces significant glare, light pollution, and energy waste. Light above 90 degrees is totally wasted and produces undesirable sky glow.

Placement: The placement of light poles within raised curb planter areas is encouraged, but conflicts with parking lot trees, which can obscure the lighting, should be avoided. The distance separating lights will be determined by the geometry of the parking lot and the requirement to satisfy illumination levels.

Control: Lighting must be designed to interface with the existing University control system where lighting is currently controlled by photocells. Each lighting circuit must be equipped with a manual over-ride switch. Lighting should be capable of bi-level control within a future campus-wide energy management system.

9.9.3 Luminaires

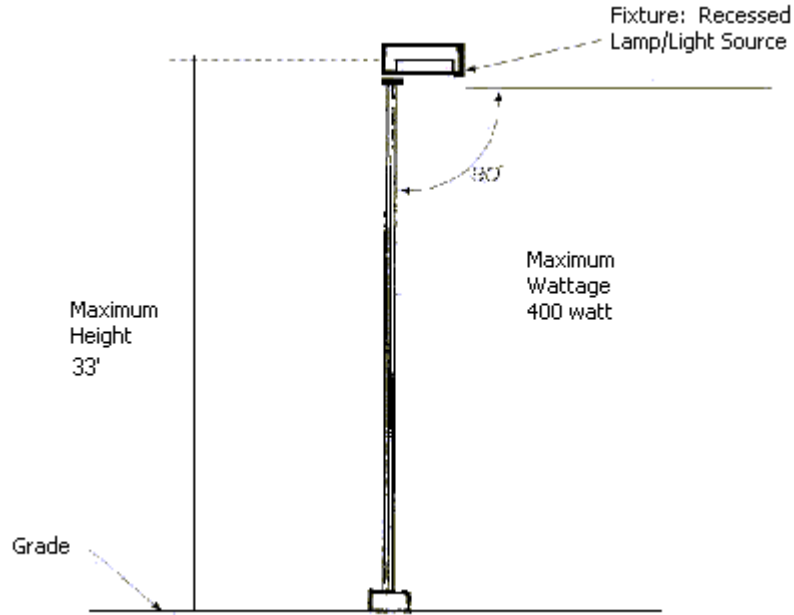
Parking lot illumination at the University of Houston is in a transitional phase between the traditional metal halide fixtures and preferred LED lighting. It is anticipated that a LED retrofit fixture adaptable to the current luminaire standard soon can be found and implemented in its place.

Mounting Height: The mounting height is measured from the finished grade or surface and includes the total height of the luminaire, pole, and any base or other supporting structure required to mount the light. Parking lot luminaires shall be designed, located and mounted at heights no greater than:

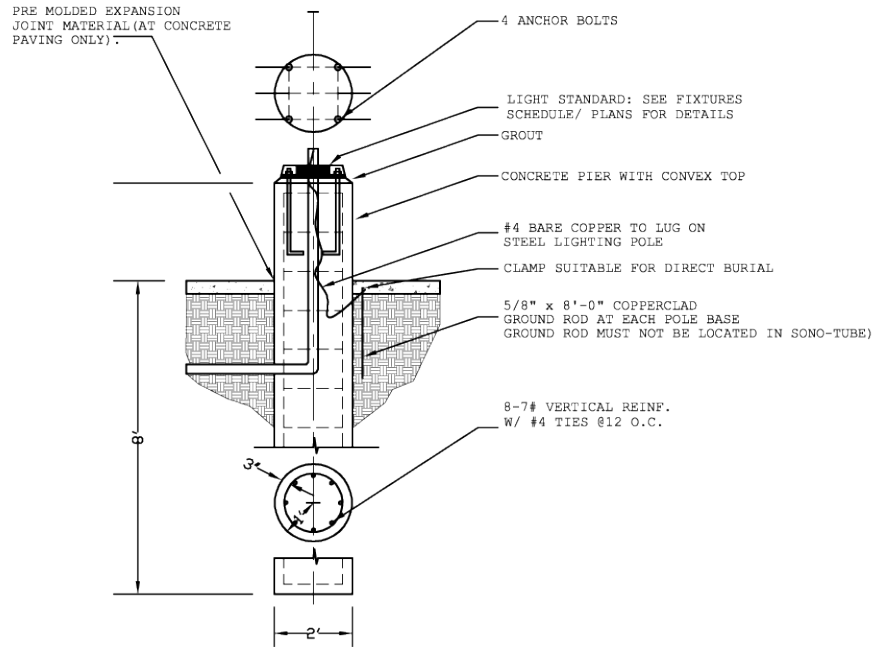
- 33-feet above grade for cutoff lights (See Figure 9.9.1)

Pole bases: Raised light pole bases shall be attractively designed and compatible with the overall campus. The standard is a 2 ft. diameter, cylindrical concrete base set 8.0 ft. below and 2.5 ft. above grade. The top of the base must be finished in a slight convex shape to prevent water pooling at the base of the light pole. (See Figure 9.9.3 for details).

Light Source: Lamps shall be metal halide (MH), 20,000 hour type. Lamps for cut-off luminaires shall not exceed 400 watts without specific approval of the University of Houston.



**FIGURE 9.9.1
CUTOFF LIGHT FIXTURE**



**FIGURE 9.9.3
LIGHT STANDARD POLE BASE**



FIGURE 9.9.4
REBAR, ELECTRICAL CONDUIT



FIGURE 9.9.5
CONCRETE LIGHT POLE BASE WITH ANCHOR BOLTS

9.9.4 Luminaire Specifications

All luminaires will have to meet the provisions of the International Dark-Skies Association. The current UH standard luminaire is:

Single Head: Lithonia Lighting model: KVR2 400M ASYC RPVD12 DBL or approved equal
Double Head: Lithonia Lighting model: KVR2 400M SYMC RPVD12 DBL or approved equal

Alternative luminaries must be approved by the University and must meet the following specifications:

Housing: Parking lot pole mounted fixtures are to be cylindrically shaped and constructed of 0.90 heavy gauge spun aluminum. The internal components of the fixture must be accessible through the top of the fixture. Access to the ballast should not require the removal of the internal reflector. EPA shall be 1.5 ft squared.

Lens: Each fixture must have impact-resistant, clear, 3/16-inch thick tempered glass drop lens.

Fixture Style: Fixtures can be either double head or single head depending upon the location of the assembly and the illumination required. Note that shielding may be required at the fixture to prevent light spillover and glare when the luminaire is set adjacent to a residential area.

Optics: The fixture must have segmented, anodized aluminum optics, field interchangeable and rotatable. Fixture shall be vertically lamped with sealed optical chamber. Optical design shall redirect light around the arc-tube for optimum lamp life and fixture efficiency.

Electrical System: Fixture must be 480V 1phase 60 cycle, constant-wattage autotransformer, high-power factor ballast. Ballast is copper wound and must be 100% factory tested. The assembly should include a removable power tray and positive locking disconnect plug. Lighting should be capable of bi-level control and should be pre-wired for a future campus-wide energy management system. Double head fixtures must be 480V 3 phase 60 cycle to balance loads.

Finish: The polyester paint finish must meet or exceed the following paint standards:

- ADHESION: ATSM D 3359
- IMPACT: ATSM D 2794
- FLEXIBILITY: ATSM D 522 (1/8' CONICAL MANDREL)
- SALT SPRAY: ATSM B 117, D 1654
- HUMIDITY: ATSM D 2247, D 1654

9.9.5 Pole Requirements

The current UH standard light pole for parking lots is:

Single Head: Valmont model: DS210 800A300 DM10 FP FBC or approved equal
Double Head: Valmont model: DS210 800A300 DM2180 FP FBC or approved equal

Alternative poles must be approved by the University and should meet the following requirements:

Anchor Bolts: Anchor bolts should be fabricated from carbon steel bar conforming to AASHTO M314 Grade-55 or ASTM F1554 Grade-55. Bolts should have an “L” bend on one end and be galvanized a minimum of 12” on the threaded end. Four anchor bolts are required per pole. Each anchor bolt must be furnished with two hex nuts and two flat washers that meet the same requirements as anchor bolts.

Anchor Base: The anchor base (base plate) shall be fabricated from structural quality hot rolled carbon steel plate conforming to ASTM A36. The base plate shall telescope the pole shaft and be circumferentially welded on top and bottom.

Pole Shaft: The pole shaft shall conform to ASTM A595 Grade-A and shall be 11-gauge thick. The pole must be of single piece construction, with a full-length longitudinal high frequency electric resistance weld. The pole shaft is to be round in cross-section and have a uniform taper of approximately 0.14 inches per foot of length.

Hand Hole: A 4” x 6.5” hand hole is to be located 1’-6” above the pole base plate. The hand hole is to be provided with a steel attachment bar, and a steel cover with hex head stainless attachment screws.

Pole Coating: Pole coating shall be a black, powder finish coat.

Surface preparation: Exterior pole surfaces must be blast cleaned to Steel Structures Painting Council Surface Preparation Specification No. 6 (SSPC-SP6) requirements utilizing cast steel abrasives conforming to Society of Automotive Engineers (SAE) Recommended Practice J827.

Interior Coating: Interior pole shaft surfaces shall be mechanically cleaned and coated at the base end for a length of approximately 2.0’ with a zinc rich epoxy powder. The coating shall be electrostatically applied and cured in a gas fired convection oven by heating the steel substrate to a minimum of 350 degrees and a maximum of 400 degrees F.

Exterior Coating: All exterior surfaces shall be coated with either Urethane or Triglycidyl Isocyanurate (TGIC) Polyester Powder to a minimum dry film thickness of 2.0 mils for Urethane Powder and 3.0 mils for TGIC Powder. The coating shall be electrostatically applied and cured in a gas fired convection oven by heating the steel substrate to a minimum of 350 degrees and a maximum of 400 degrees F.

9.9.6 Maintenance

The current UH standard luminaire and pole selections are designed to accommodate maintenance accessibility, with long ballast and lamp lives, and to resist dirt, animal droppings, bird nests, vandalism, and water damage.

Note that outdoor lighting fixtures require regular maintenance. Lamps tend to produce less light as they age and should be replaced at scheduled intervals and not just when they burn out. Dirty light fixtures also produce less light. Arrange to have the luminaires cleaned both inside and outside on a regular basis.

The growth of trees and other types of landscaping can have a significant effect on outdoor lighting. Even a well-designed lighting system can become ineffective as trees grow to a point

where they block out large portions of the light. Arrange to have trees and landscaping regularly trimmed so that the lighting system is not adversely affected.

9.10 MARKING AND STRIPING

9.10.1 Layout

The project design drawings must include a detailed and accurately scaled parking lot layout clearly showing the location of parking spaces and aisles. The dimensions of the parking spaces, aisles and driveways must conform to the layout design standards included in this guideline.

9.10.2 Marking

The construction documents should require the parking spaces to be marked on the parking lot surface according to layout shown on the project design drawings, and should conform to the following criteria:

Each required parking space shall be identified by surface markings and shall be maintained in a manner so as to be readily visible and accessible at all times. Such markings shall be arranged to provide for orderly and safe loading, unloading, parking and storage of vehicles.

One-way and two-way access into parking facilities shall be identified by directional arrows. Any two-way access located at any angle other than 90 degrees to a street shall be marked with a traffic separation stripe the length of the access. This requirement does not apply to aisles.

Markings that are required to be maintained in a highly visible condition include striping, directional arrows, lettering on signs, lettering in handicapped-designated areas, and field color.



**FIGURE 9.10.1
ACCESSIBLE SPACE MARKING**

Each loading space shall be striped or permanently designated by other suitable methods and permanently posted with a sign restricting its use to loading.

Parking spaces shall be permanently marked with striping in accordance with all federal, state and local standards. As a minimum lines, shall be located along the sides and, unless curbing is present, at the head of parking stalls. Lines shall be four (4) inches wide and should extend the full length of the space.

“YIELD” markings shall be painted in yellow letters a minimum of 36” high at the end of each parking row as it intersects either a drive lane or another parking row that has priority flow for traffic.



**FIGURE 9.10.2
YIELD MARKINGS AND YELLOW STRIPING**

9.10.3 Striping

Please note that in December 2015, the US Department of Justice released an ADA Compliance Brief affecting handicapped parking striping and parking lot ramp configuration. Please see http://www.ada.gov/restriping_parking/restriping2015.pdf for details.

Striping shall be one consistent color, semi-permanent, reflective traffic paint with reflective glass beads to enhance visibility. See Master Construction Specification Division 32 Exterior Improvements for paint specifications.

Parking spaces will be striped white except at the end of each row of parking or at handicapped accessible aisles. These lines will be painted yellow. All cross walks, no parking areas and access walks will be striped in yellow.

Parking spaces are a minimum of 8' 6" wide from center of stripe to center of stripe. All lines must be 4" wide.



**FIGURE 9.10.3
STRIPING**

9.10.4 Re-striping

When an existing parking lot is re-striped, the re-striping must provide accessible parking spaces as required by the ADA Standards for Accessible Design and the Texas Accessibility Standards (TAS). These requirements are outlined in Section 3 and Section 5 of this Manual.

9.11 SIGNAGE

9.11.1 General

Parking, handicap, and other signage must conform to the U.S. Department of Transportation *Manual on Uniform Traffic Control Devices Standard* and the Americans with Disabilities Act standards. All signs must meet University of Houston standards for colors and lettering.

9.11.2 Sign Size

All signs must have a ratio that is neither greater than 3.20 nor less than 1.75 (ratio: divide the length by the height).

Street signs and standard roadway signs will be 18" wide by 24" high. Examples include "Do Not Enter" and "One Way" (without arrow). See Figure 9.11.1.

Handicap (ADA) and other parking signs will be 12" wide by 18" high. See Figures 9.11.2 and 9.11.3



**FIGURE 9.11.1
STANDARD STREET AND ROADWAY SIGNS (18"×24")**



Colors
Legend and Border -- Green
White symbol on Blue background
Background – White

**FIGURE 9.11.2
ACCESSIBLE PARKING SPACE SIGN (12"×18")**

9.11.3 Font Size

Font size is strictly dependent on the nature of the sign; i.e. whether the sign is intended for vehicular or pedestrian traffic. Only the rules that apply to traffic around the University are detailed in Figure 9.11.3.

Travel Speed	Traffic Category	Reading Distance	Appropriate Letter Height	Appropriate Symbol Size
0 mph	on campus pedestrians	5 feet	1 inch	4 inches
0-10 mph	pedestrians cyclists rollerbladers	10 feet	2 inches	8 inches
10-40 mph	Vehicular	20 feet	4 inches	16 inches

FIGURE 9.11.3 SIZES FOR CAMPUS SIGNAGE

9.11.4 Sign Materials

Sign materials depend upon the following criteria:

- DOT standards include 0.080 gauge aluminum signs covered with Approved Engineer Grade (SEG) reflective sheeting for street and parking signs.
- ADA standards include a 6" pictogram with verbal description, 1/32" raised letters and numerals, 5/8" minimum letter height, raised grade 2 Braille, and 70 percent contrast between background and text for all handicap signage.
- All other signs can be made from metal or Dura-ply.

9.11.5 Pole/Mounting Post

Poles shall be manufactured or constructed of 2" O.D. round galvanized pipe. Poles for street signs or standard roadway signs should extend 9' 0" above the parking surface. Poles for Handicap markings should be 6' above the pavement. All poles must be set in concrete footings extending a minimum of 2' 6" below the surface. Signs should be mounted as close to the top of the post as possible. See Figure 9.11.4 for details.

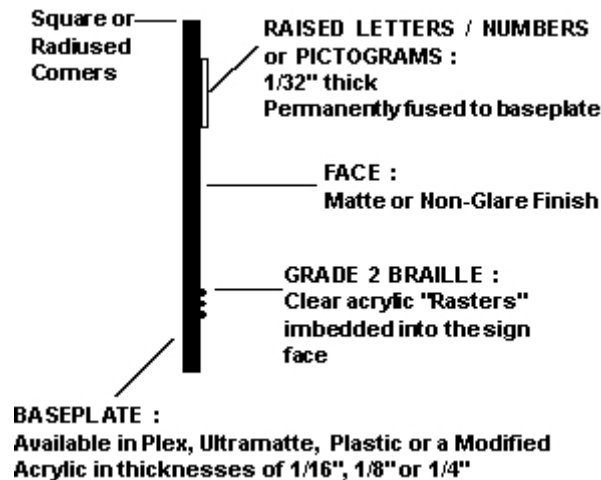


FIGURE 9.11.4
STANDARD POLE DETAILS



**FIGURE 9.11.5
ACCESSIBLE PARKING SIGN WITH FINE**

9.11.6 Quality Assurance

Manufacturer should have a minimum of 5 years experience in manufacturing signage. All signage is to be manufactured by one manufacturer. Install traffic signs in accordance with the manufacturer's written installation instructions and the project plans.

9.11.7 Replacement

All signs should be replaced on an as-needed basis to reflect the proper image of the University.

9.12 PARKING BARRIERS

9.12.1 Purpose

All parking areas and spaces shall be provided with bumper barriers, wheel stops, or wheel stop curbing designed to prevent parked vehicles from extending beyond the property lines, damaging adjacent landscaping, walls or buildings, or overhanging sidewalk areas. Each handicapped accessible parking space without a curb stop should be furnished with a parking barrier. Barriers should not block the access aisles between handicapped accessible spaces.

9.12.2 Approved Barriers (Wheel Stops)

Prefabricated concrete parking barriers, where used, shall be a minimum of 6" wide, 6" high, and 6 feet long (See Figure 9.12.1). Prefab barriers must be firmly and permanently anchored a minimum of 12" below the pavement with galvanized anchor pins (See Figure 9.12.2).

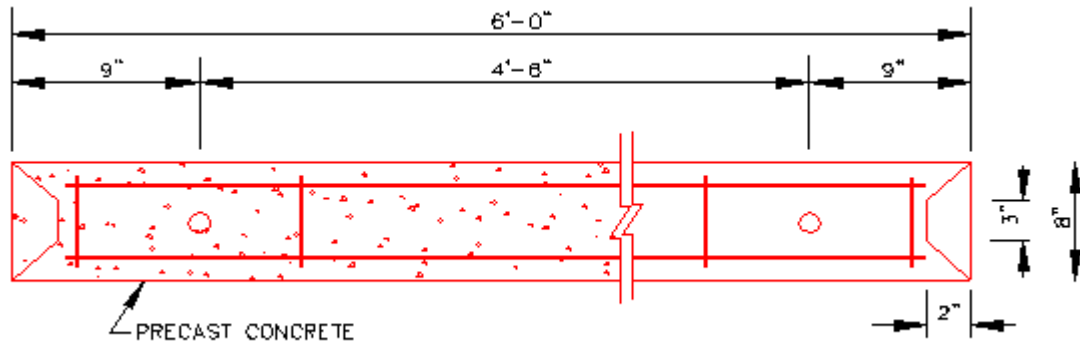


FIGURE 9.12.1
PRE-CAST CONCRETE PARKING BARRIER

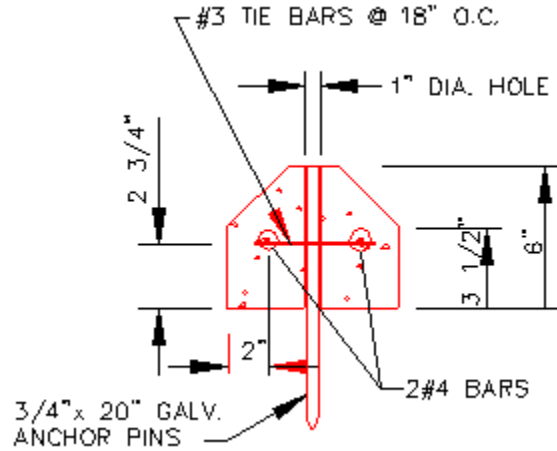


FIGURE 9.12.2
PARKING BARRIER ANCHORS

9.12.3 Location

Barriers should be located to contain the parking within the approved parking lot. When a concrete curb is used as a barrier for perpendicular or angle parking, it should be offset at least two (2) feet from the edge of the parking lot to allow for the front overhang of the vehicle.

9.12.4 Painting/Marking

All parking barriers (wheel stops) will be painted white except for the following:

- Yellow – No Parking / Tow Away Zones
- Red – Emergency Vehicle / Fire Zones

- Blue – Handicapped Parking
- Black Letters – Denote Reserved Spaces (usually with a space number)

9.12.5 Benefits

Properly placed barriers protect structures and landscaping from vehicle damage.

Bumpers encourage drivers to pull all the way into a parking space. This ensures adequate clearance behind the vehicle for other traffic.

Bumpers along a centerline of a double row of parking can prevent drivers from taking unsafe short cuts through a parking lot.

9.13 LANDSCAPING OF PARKING AREAS

9.13.1 General

The requirements described under this section include the minimum provisions prescribed in the City of Houston Code of Ordinances, Chapter 33: Planning and Development, Article V: Trees, Shrubs and Screening Fences. The intent of these guidelines is to establish standard criteria for landscape design of all new and/or renovated surface lot parking areas.

9.13.2 Existing Condition

The vast majority of campus parking consists of large expansive lots situated along the perimeter of campus. Many of the lots have been screened with continuous rows of shrub hedges and trees. There are little or no landscape treatments in the interior of the lots.

9.13.3 General Guideline

Vehicular parking areas shall be both functionally and aesthetically pleasing. The overall goals of implementing these requirements are to enhance, beautify, provide aesthetic unity with the rest of the campus environment, improve the environmental and climatic impact of surface parking lots and to minimize the vast, barren character of existing and future parking areas while providing efficient parking, vehicular circulation and safe pedestrian access. Large canopy trees shall dominate the parking areas for shade and shrubs along the perimeter shall be provided for screening.

The University will implement a sequence for phasing in renovation of existing parking lots that contain little or no landscaping to meet the requirements of this section. This sequence is not a timetable and implementation will occur as funding becomes available. First priority will be given to Campus Core lots and/or other high profile lots, with the renovations moving out to the large, outlying lots on the edge of Campus.

9.13.4 Numerical Requirements

The parking lot design shall include one (1) tree for every ten (10) parking spaces, rounding up or down in the case of a fraction to the nearest whole number, and in no case shall be less than one

(1) tree. Required trees must be located in the interior of, or an area adjacent to the parking lot. For parking lots with more than 20 parking spaces, a minimum of five percent (5%) of the total interior parking lot area shall be landscaped (excluding perimeter landscaping).

In addition to the parking lot tree requirements described above, shrubs shall be planted along the perimeter of all parking surfaces so that the parking lot is screened from all adjacent public streets, exclusive of driveway entrances, pedestrian walkways and visibility triangles. Shrubs shall be maintained at a height of no more than 36 inches nor less than 18 inches as measured from the surrounding soil line. The number of shrubs required shall be equal to the total number of street trees required multiplied by ten (10). No less than 75 percent of the shrubs required under this section shall be planted along the perimeter of the parking surface adjacent to the public street. A minimum 10'-0" wide landscaped area, exclusive of sidewalks and utility easements, shall be provided between the parking lot and street right of way to accommodate the required screening shrubs.

9.13.5 Design Requirements

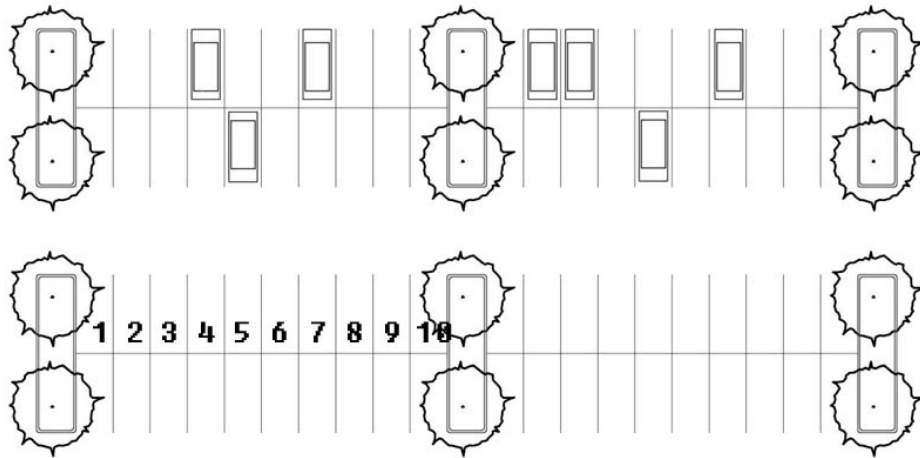
Landscape islands shall be created to comply with the above numerical requirements, to provide shade canopy and to break up the visual monotony of large asphalt covered areas. The requirements are as follows:

- Landscaped terminal islands shall be provided at the end of each parking row. Terminal islands shall contain at least one (2) trees and shall be the approximate size of two (2) parking spaces.
- Additional intermediate islands shall be created when the maximum number of parking spaces between terminal islands is greater than twenty (20). (See Figure 9.13.1)
- All landscaped islands shall be a minimum of 250 sq. ft.
- All landscaped islands shall be provided with raised concrete curbs to prevent vehicular intrusion.

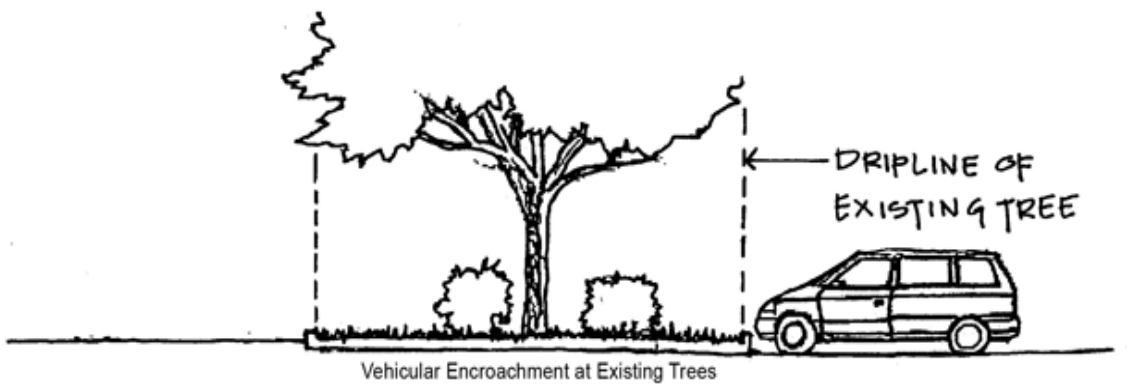
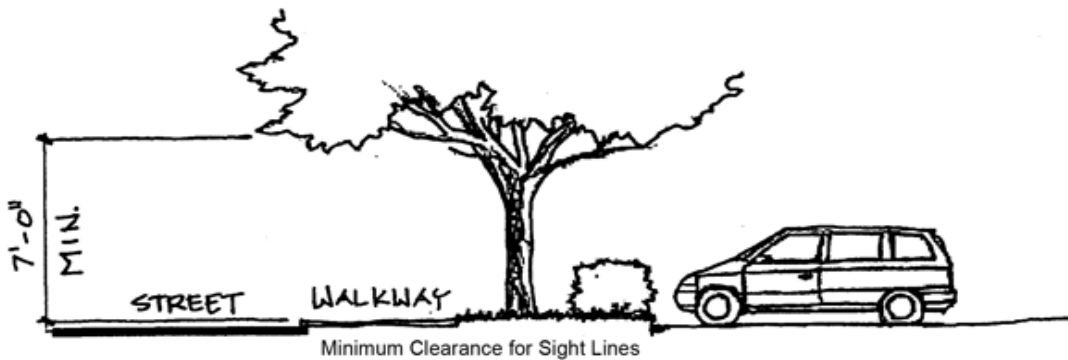
9.13.6 Additional Requirements

- No tree shall be planted closer than three (3) feet to a curb.
- All new trees shall have a minimum caliper of 4" at installation.
- All required landscaped areas shall be provided with a permanent and adequate means of irrigation and shall be adequately maintained.
- Each island and screening buffer zone shall be planted with ground cover or sodden lawn in addition to canopy trees.
- Large canopy shade trees are required for terminal islands and must be suitably sized, located and maintained to provide a clear trunk height of seven (7) feet at maturity to allow for unobstructed sight lines. A combination of canopy and ornamental trees that add color and variation may be planted in perimeter areas. Final species selection shall be coordinated with the FP&C Project Manager and Grounds Maintenance representative.
- Where canopy trees are located along the perimeter with screening shrubs, sight lines shall be maintained between the underside of the canopy and the top of the shrubs for security. (See Figure 9.13.2)
- All landscaping shall be arranged so as not to obscure traffic signs or fire hydrants, or obstruct drivers' sight distance within the parking area and at driveway entrances.

- Preserve existing trees where possible, especially native species. All trees that have been designated by the University as existing to remain or existing to be relocated shall be protected and moved according to UH Grounds Maintenance requirements.
- No new parking lot or sidewalk paving or curbs shall encroach within the drip line of existing trees. No equipment, dirt or construction materials shall be stockpiled within the dripline of existing trees.



**FIGURE 9.13.1
PARKING**



**FIGURE 9.13.2
LANDSCAPING OF PARKING AREAS**

9.14 MAINTENANCE AND REPAIR

9.14.1 Introduction

All pavements require maintenance. They need this attention because stresses producing minor defects are constantly at work. These stresses may be caused by traffic loads, temperature fluctuations, or by changes in moisture content in the soil. Regardless of the cause, the result is the same -- without timely maintenance the pavement ultimately deteriorates. Preventive maintenance means the early detection and repair of minor defects, before major corrective action is necessary; it is the only proper way to care for a parking lot.

9.14.2 Proper Drainage

For the maintenance of parking lots, moisture and drainage have three implications. First, a properly functioning drainage system can eliminate a number of future maintenance problems. Second, surface repair of a pavement defect caused by poor drainage will merely be a temporary solution, since it treats only the symptom, not the cause. Third, the most important repairs are those that will stop water from getting beneath the pavement surface. These repairs can prevent even larger maintenance expenditures in the future.

9.14.3 Inspection and Evaluation

The key to successful maintenance is careful planning and programming of the work to be done. The first step in planning is a periodic evaluation of all parking areas and access roads in the system.

The parking lot should be thoroughly inspected at least twice a year for surface condition, structural strength, and drainage. The inspection should be done on foot rather than from a slow-moving vehicle. This enables the inspector to notice very small cracks and defects. Subtle signs of future trouble, such as mud or water on the pavement, can be detected and recorded.

In all cases of pavement distress, it is important to determine the cause(s) of the difficulty. This will facilitate repairs that will both correct the defect and prevent its recurrence. Time and money spent for such repairs are well invested, since the same repairs will not have to be repeated in the future.

When the inspection has been completed, there should be a record of problem areas, as well as an idea of the general condition of the pavement.

When these inspections reveal minor defects they should be repaired immediately, before they deteriorate into pavement failures requiring major maintenance expenditures.

9.14.4 What to Look For

Pavements in need of maintenance or repair can exhibit any or all of these conditions:

Raveling. This is the progressive separation of aggregate particles in a pavement from the surface downward. Usually, the fine aggregate comes off first and leaves little "pock marks" in the pavement surface. As the process continues, larger and larger particles are broken free, and the

pavement soon has the rough and jagged appearance typical of surface erosion. Raveling can result from lack of compaction during construction, construction during wet or cold weather, dirty or disintegrating aggregate, poor mix design, or extrinsic damage to the pavement.

Alligator Cracks. These are interconnected cracks forming a series of small blocks resembling an alligator's skin or chicken wire. In most cases, alligator cracking is caused by excessive deflection of the surface over unstable sub grade or lower courses of the pavement. The unstable support usually is the result of saturated granular bases or sub grade. The affected areas are usually not large. They can cover entire sections of a pavement, and when this happens, it usually is due to repeated heavy loadings exceeding the strength of the pavement.

Upheaval. Upheaval is the localized upward displacement of a pavement due to swelling of the sub grade or some portion of the pavement structure. Upheaval may also be caused by the swelling effect of moisture on expansive soils.

Pot Holes. These are bowl-shaped holes of various sizes in the pavement, resulting from localized disintegration of the pavement under traffic. Contributory factors can be improper asphalt mix design, insufficient pavement thickness, or poor drainage. Also, potholes may simply be the result of neglecting other types of pavement distress.

Grade Depressions. Depressions are localized low areas of limited size that may or may not be accompanied by cracking. They may be caused by traffic heavier than that for which the pavement was designed, by settlement of the lower pavement layers, or by poor construction methods. A depressed, cracked area frequently denotes a plastic failure in the base or sub grade. A cracked area without permanent deformation often indicates an elastic movement in the pavement structure.

Effects of Tree Roots. This is either an upheaval situation in which the growth of the tree roots pushes the pavement up or a depression due to the trees removing moisture from the soils under the pavement. Treatment of these areas should be coordinated with the Campus Grounds Department.

9.14.5 Corrective Actions

These are some typical cases of pavements requiring maintenance, and the proper methods of correcting the deficiencies.

Pavement in Good Condition. Typically, a pavement in good condition might exhibit fine cracking, and some raveling of the fine aggregate; the ordinary effects of some wear and tear.

The remedy for this condition is the application of a light seal coat, such as a fog seal or an emulsified asphalt slurry seal. For University of Houston Parking lots seal coating shall consist of two coats of coal tar asphalt sealer with eight pounds per gallon of concentrate sand aggregate and 5% latex additive. Seal coat should be allowed to cure for a minimum of 24 hours before re-striping and marking.

All newly paved lots should be seal coated within 12 months of completion and every three years thereafter to maximize the life of the pavement.

Pavement in Fair Condition. Such a pavement is characterized by random cracks of up to 13 mm (1/2 in.) in width, and raveled aggregate. Seal these cracks by:

- If needed, rout out the crack to the sealant manufacturers' specifications for width to depth ratio. Clean the crack using wire brushing, high-pressure air, sandblasting, hot air blasting, or high-pressure water. This is a key step to crack sealing or filling. If the crack is not thoroughly cleaned the sealant will not adhere to the sides. Thoroughly dry the crack before sealing.
- After removing the old sealant and/or cleaning the cracks, check them for depth. Generally if they are over 19mm (3/4 in.) deep a backer rod is used to conserve sealant. The backer rod should be a compressible, non-shrinking, non-absorbent material with a melting point higher than the sealant temperature. The backer rod should be about 25% wider than the crack so it doesn't slip down, or float out after installing the sealant.
- Immediately before applying the sealant, inspect the cracks to ensure they are clean, dry and any backer material is properly installed. If the cracks have been left unsealed for any period of time, clean them out with compressed air before sealing them.
- The sealant should be applied from the bottom to the top of the crack to prevent air bubbles from forming and creating a weak spot in the sealant. Use a sealant kettle that has an injection wand for the best results. To prevent tracking the sealant should be left about 3 to 6 mm (1/8 to 1/4 in.) below the top of the crack. Use a squeegee to remove any excess sealant on the pavement surface.

Pavement in Poor Condition. This pavement may display random cracks, raveled aggregate, depressions, alligator cracks, potholes, and perhaps upheaval. Repairs these areas by:

- First, the areas of local distress -- areas containing alligator cracks, potholes, and upheavals -- should be repaired. This is accomplished by constructing a Full-Depth asphalt patch.
- Following the repair of local distress, cracks should be filled.
- Depressed areas should be restored to the proper cross-section by applying a leveling or wedge course. This is an asphalt layer of variable thickness, specifically intended to eliminate irregularities in the contour of an existing surface prior to an overlay.
- Finally, an asphalt overlay or slurry seal should be applied.

9.15 UNFORESEEN CIRCUMSTANCES

9.15.1 Purpose

This section outlines the appropriate steps to be followed when unforeseen circumstances or condition occur during the construction of parking lots on the University campus. This section is also aimed at providing the appropriate contacts in the various university departments so that the problem is solved in the most efficient way.

9.15.2 Initial Actions

Whenever an unforeseen circumstance is encountered the Contractor should immediately notify the appropriate Project Managers, i.e. the University of Houston Project Manager and the Contractor's Parking Lot Project Manager (if the contractor uncovering the circumstance is a sub-contractor). The decision regarding the solution of the problem rests initially with these Project Managers. These Project Managers, or the personnel assigned by the Project Managers, are responsible for contacting the respective agencies or departments affected by the circumstance. If an unsafe circumstance is encountered, work in the affected area should immediately cease and all non-essential personnel should vacate the immediate area to a safe distance and await a decision by the appropriate agency.

9.15.3 Contacts

Following is a list of contacts for specific items uncovered during construction (numbers as of 7/20/2015):

- For general inquires:

FACILITIES, PLANNING AND CONSTRUCTION (713) 743-8025

- Telephone/telecommunications, fiber optic cables (buried, encased in concrete, etc):

DATA COMMUNICATIONS (713) 743-1111

- Electrical lines or devices:

UTILITY SERVICES (713) 743-5791

- Water, steam or other utility lines:

UTILITY SERVICES (713) 743-5791

- To report a theft or vehicles trespassing on construction sites:

CAMPUS POLICE (713) 743-0600 (non-emergency)

- Sprinkler lines or sprinkler system problems:

GROUNDS DEPARTMENT (713) 743-5745

- General parking and access questions:

PARKING AND TRANSPORTATION (713) 743-1097

- Physical safety questions:

FIRE DEPARTMENT (713) 743-1635

9.16 WORKING WITH CAMPUS STAFF

9.16.1 Purpose

Because of the potential negative impact on faculty and staff due to lot closures, construction traffic, traffic barriers, etc., any contractor engaged in parking lot work for the University of Houston must be prepared to interface and coordinate with the appropriate University departments. This section addresses the principal construction issues and the relevant University departments that need to be contacted in order to resolve issues either in anticipation or as they arise.

9.16.2 Parking Permits

Except for outlying and visitor lots all University of Houston Parking Lots require a permit for parking. Contractor parking is available at ERP with Owner provided bus service at designated times.

UH Department of Parking & Transportation may allow, at its option, a small number of Contractor cars to be parked within a project's construction limits. No other on-campus parking will be provided to or used by Contractor or any of its employees, subcontractors, consultants, agents or representatives.

Permits for the duration of a project may be secured through the Facilities, Planning and Construction Office. Failure to display these permits may result in ticketing or towing. Contractor vehicles shall park in authorized spaces and shall not park on the grass or in other ways to disrupt traffic.

9.16.3 Construction Barriers and Marking

All construction sites should be clearly and adequately marked to prevent non-construction personnel from entering the site without approval. Construction barriers, cones and orange plastic fencing should be used to prevent pedestrians and non-construction vehicles from inadvertently entering the work area. Sub-contractors are responsible for the safety of all personnel entering or leaving the work site.

9.16.4 Lot Closures

Whenever a parking lot must be closed for construction or repairs three to five class days' notice is required. The Parking and Transportation Department will arrange to notify users of the lot being closed. It is imperative that lot closures, especially during normal class times, are kept to an absolute minimum. Since the University also functions as a cultural center these lot closings must be extremely flexible.

9.16.5 Campus Police

If roads or driveways need to be closed for limited periods of time to allow access for heavy equipment, the Campus Police will make arrangements for officers to control and reroute traffic on campus. Campus Police should be given at least three days' notice of these requirements.

9.17 GLOSSARY Industry Glossary such as that at http://www.asphaltinstitute.org/wp-content/uploads/Asphalt_Industry_Glossary_of_Terms3.pdf

SECTION 10.0

WAYFINDING STANDARDS AND GUIDELINES

10.1. INTRODUCTION

The University of Houston is a large urban campus that is largely accessed by its community through the automobile. Wayfinding is very important to this community, especially to first time visitors and new students, faculty, and staff. The wayfinding process begins at the freeways and major thoroughfares that border the UH campus, flow to the parking lots, and then onto the campus. The on-campus wayfinding is shared by everyone and consists largely of maps and building names. Once inside the buildings the interior signage is a typical service with the room numbering system carried out in accordance with the THECB recommendations.

This section is divided so as to reflect the sequential experience of wayfinding: exterior directional signage for getting to the campus and locating parking areas; external on-campus signage for navigating once on the campus; and interior signage for finding one's way inside a building.

SIGNAGE TYPES:

TXDOT Signage	Parking Identifier
City of Houston Signage	Bike Path Marker
Perimeter and Public Thoroughfare Directional Sign	Exterior Building Name Graphics
Entrances and Campus Vehicular Directional Sign	Building Street Addresses
Building Identifier	Dedication Plaque
Pedestrian Directional	Street Name with UH Logo
Pedestrian Directory Kiosk	Shuttle Bus Stop Sign
Alternate and Special Exception Monument Sign	Area Patrol Sign
	Traffic Control Sign
	Interior Building Signage (various)

10.2. EXTERIOR DIRECTIONAL SIGNAGE

10.2.1 TEXAS DEPARTMENT OF TRANSPORTATION (TXDOT) SIGNAGE

A significant portion of the northern and eastern edges of the campus are defined by Interstate 45 and Spur 5. Examples of TxDOT signage that begin the wayfinding process to campus can be found at I-45 and Cullen Blvd., Spur 5 and University Drive and Spur 5 and Wheeler Ave. (See **Figure 10.1**) Once the visitor has exited the freeways, the UH entrance monument sign (usually on a boulevard) begins the on-campus directional signage. (See **Figure 10.2**).



FIGURE 10.1
TXDOT SIGNAGE-I-45 EXITS

10.2.2 CITY OF HOUSTON SIGNAGE

Similar to the TxDOT signage, City of Houston signs point the way to the major thoroughfares that cross the campus. An example can be found at the I-45 feeder road and Cullen Boulevard.

10.2.3 UNIVERSITY OF HOUSTON EXTERIOR DIRECTIONAL SIGNAGE

In the latter part of 2013 and early in 2014, the University began to implement a new wayfinding graphics package based on the division of the campus into seven districts, each with its own specific color. Individual signs include the color of the district in which they are located, and sign copy is kept to a minimum. Phased implementation in the other districts was underway.

Please contact a University of Houston FP&C or FM Project Manager for the most current information on signs required by construction projects. A rendering of the Campus Exterior Wayfinding Signage Family as of February 25, 2014 is attached as **Figure 10.2**.

PERIMETER AND PUBLIC THOROUGHFARE DIRECTIONAL SIGN

See Campus Exterior Wayfinding Signage Family, Type A

ENTRANCES AND CAMPUS VEHICULAR DIRECTIONAL SIGN

See Campus Exterior Wayfinding Signage Family, Type B

PEDESTRIAN DIRECTIONAL

See Campus Exterior Wayfinding Signage Family, Type C

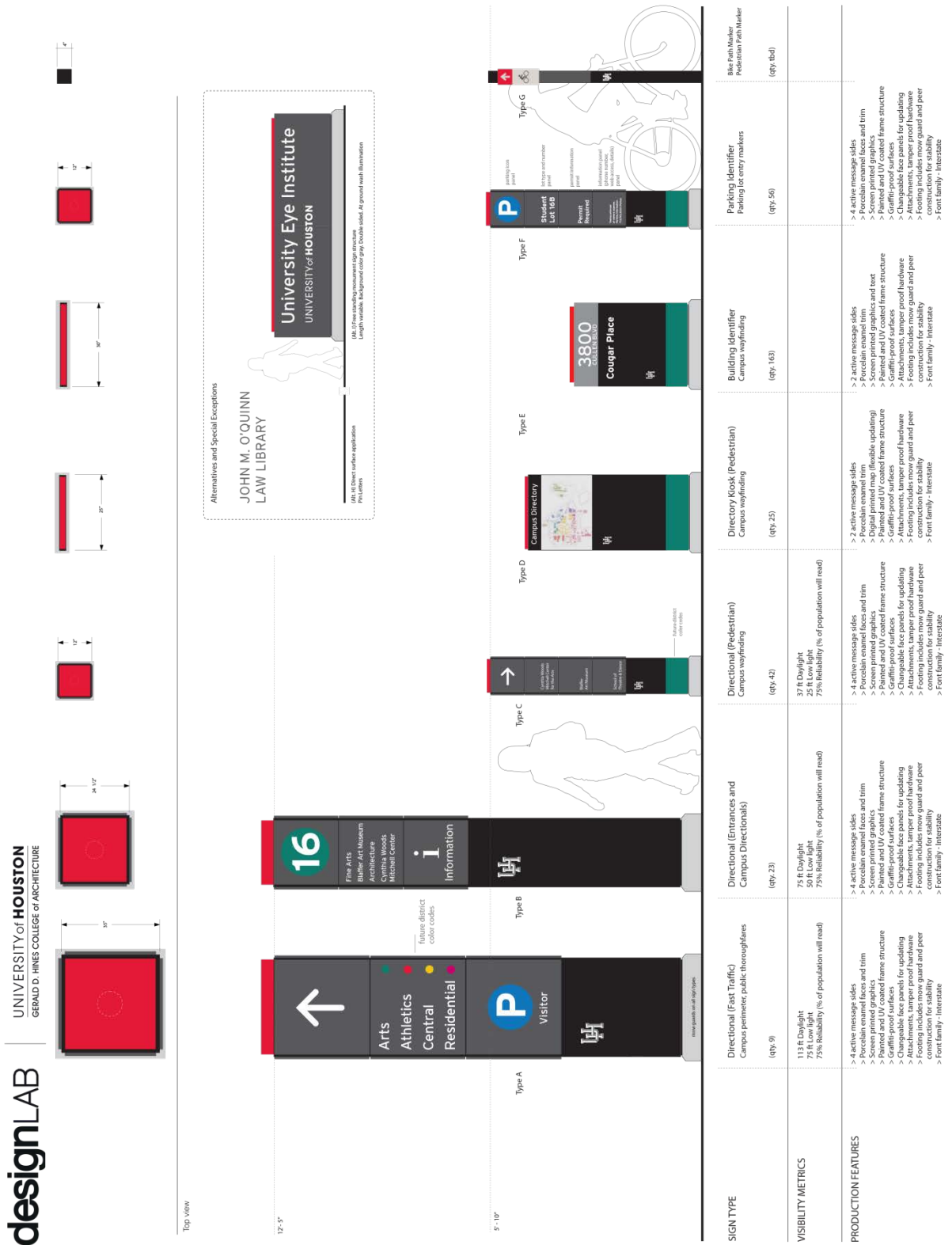


FIGURE 10.2
CAMPUS EXTERIOR
WAYFINDING SIGNAGE
FAMILY

PEDESTRIAN DIRECTORY KIOSK

See Campus Exterior Wayfinding Signage Family, Type D

ALTERNATE / SPECIAL EXCEPTION MONUMENT SIGN

See Campus Exterior Wayfinding Signage Family, Type Alt. H

BUILDING IDENTIFIER

See Campus Exterior Wayfinding Signage Family, Type E

PARKING IDENTIFIER

See Campus Exterior Wayfinding Signage Family, Type F

BIKE PATH MARKER

See Campus Exterior Wayfinding Signage Family, Type G

10.2.4 UNIVERSITY OF HOUSTON BUILDING EXTERIOR GRAPHICS

BUILDING NAME

In addition to a Building Identifier Sign, exterior building graphics (building name at a minimum) shall be carved in the exterior wall material or shall be surface mounted at the main entrance in such a location as to be easily visible to the pedestrian from a distance. If surface mounted, the letters shall be of permanent and durable material such as bronze, aluminum, or stainless steel and shall be approved by FP&C. (See **Figure 10.3**)

Building name shall be externally illuminated in accordance with SECTION 11.0 LIGHTING DESIGN GUIDELINES.

Exterior building graphics (building name and/or donor name) utilizing large scale lettering intended to be viewed above the pedestrian level from a distance shall be reviewed and approved by the Campus Facility Planning Committee. Any internal illumination of the graphics shall also be reviewed by the Campus Facility Planning Committee.

BUILDING IDENTIFIER PROTOCOL

Names of departments located within the building may not be listed on the Building Identifier sign. This guideline, which has been in place since at least 2002, is necessary due to the approximately 400 names of departments and organizations that otherwise would have to be added to the signs and the difficulty of keeping such information accurate.

When a public destination is located within a building (such as Blaffer Museum or Dudley Recital Hall), a variance request may be submitted to the Campus Facility Planning Committee.



**FIGURE 10.3
EXAMPLES OF BUILDING NAME GRAPHICS**

BUILDING STREET ADDRESSES

Street address numbers meeting the requirements of the current NFPA 1 and City of Houston Fire Code shall be displayed on each building. Letter size is generally 6” but may be taller if located higher on the building elevation. Vinyl letters at glass entries and aluminum pin-mounted letters are common installations. Contact FPC/FS Project Manager for current requirements.

DEDICATION PLAQUES

Dedication plaques shall be of incised stone or cast metal or as approved by FP&C. Plaques shall comply with the requirements of University of Houston System Board of Regents Policy Number 53.02: (See **Figure 10.4** for example)

53.02 Building Identification Plaques

Building identification plaques shall be placed in all new buildings constructed by the System.

53.02.1 Contents

Building identification plaques shall contain:

- A. the name of Texas governor at the time of approval of the project;*
- B. the names of Chair, Vice Chair, Secretary and other members of the Board at the time of approval of the project;*
- C. the names of the Chancellor and component University President at the time of approval of the project;*
- D. the names of architects;*
- E. the name of general contractor;*
- F. the year project is approved; and*
- G. the year building construction is completed.*

53.02.2 Definitions

The “time of approval” date shall be the date the Board approves the project program, budget, schedule, and schematic design.

The “completion” date shall be the date established by the certificate of substantial completion as issued by the architect and approved by the Executive Vice Chancellor for Administration and Finance.

(08/17/11)

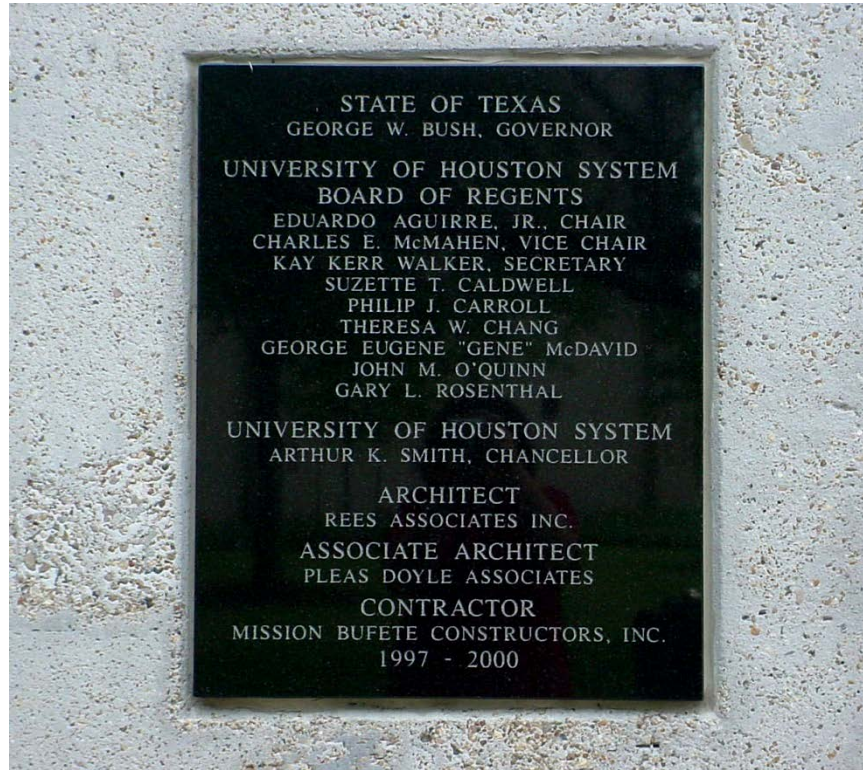


FIGURE 10.4
EXAMPLE OF DEDICATION PLAQUE
(LEROY AND LUCILE MELCHER CENTER FOR PUBLIC BROADCASTING)

10.2.5 EXTERIOR MISCELLANEOUS SIGNAGE

STREET NAME SIGN with UH Logo

To delineate the boundaries of and routes to the main campus, all standard green on white City of Houston street name signs at major intersections on campus have been replaced with special UH street signs (See **FIGURE 10.5**).

Campus street name signs are black with white copy in standard fonts and sizes. The street name is 4" high standard block font, with the street type (e.g. Drive, Blvd., Street) and the block number in 1" high standard block font. At the top of the pole is a 9"W x 9 3/4"H aluminum sign painted red to match the approved University standard, with a 6" high interlocking UH logo in white reflective vinyl outlined in black. (See Figure 10.6)

SHUTTLE BUS STOP SIGN

Production and installation of shuttle bus signs is the responsibility of the UH Parking and Transportation department.

New building site designs and parking lot designs shall take into consideration the potential requirement of new shuttle bus stops with covered waiting structures. New

location requirements shall be determined by Parking and Transportation and incorporated into the project design. (See **FIGURE 10.6**).

AREA PATROL SIGN

The location of new area patrol signs shall be determined by the University of Houston Department of Public Safety and conveyed to FP&C for fabrication and installation (See **FIGURE 10.7**).

- Each sign shall be 17.5”H x 14”W, made of 1/8” aluminum and mounted on a 2” aluminum pipe with the top of the sign at 8’-0” above grade. The pipe shall be installed in a 8” diameter concrete footing that extends 2’-0” below finished grade.
- The signs shall be painted black to match Imron color #99, semi-gloss. A 2” section at the top of the sign shall be painted red to match the approved University sample and shall contain the interlocking UH logo in the left hand corner.
- All text copy shall be white reflective vinyl of a font and size to match existing signs. The UH Police logo shall be of digitally printed vinyl and placed in the center of the sign. (See **Figure 10.7**)

TRAFFIC CONTROL SIGNAGE

All traffic control signage on the University of Houston campus shall conform to the *Texas Manual on Uniform Traffic Control Devices for Streets and Highways*.

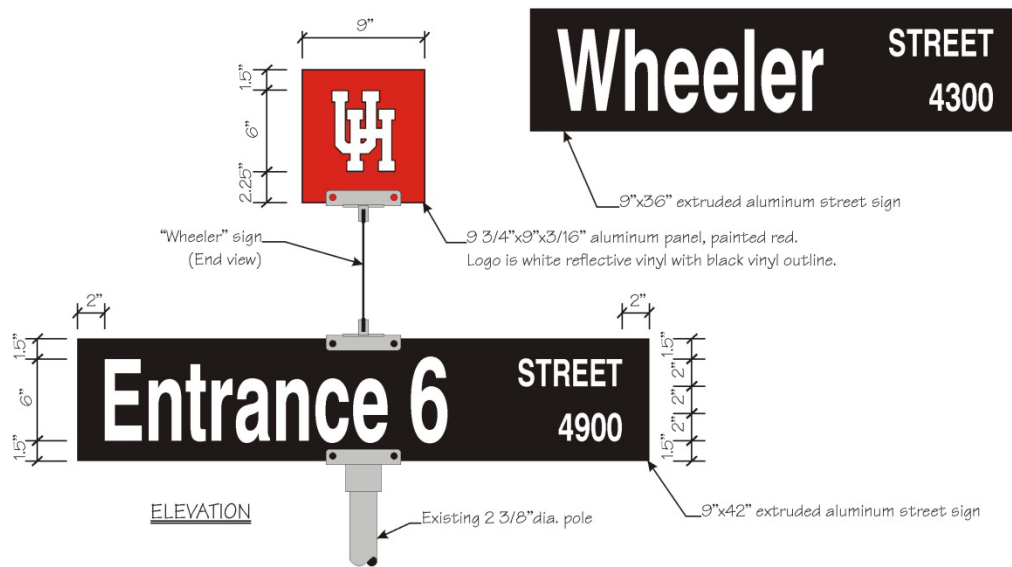
- See also UH Design Guidelines and Standards Section 9: Parking, 9.11—Signage.



**FIGURE 10.5
STREET NAME SIGN with UH LOGO**



**FIGURE 10.6
SHUTTLE BUS SIGN**



5

Use current UH interlocking mark for all signage requiring logos (see <http://www.uh.edu/policies/graphicstandards/graphic/index.php#uhmark> for current interlocking mark)

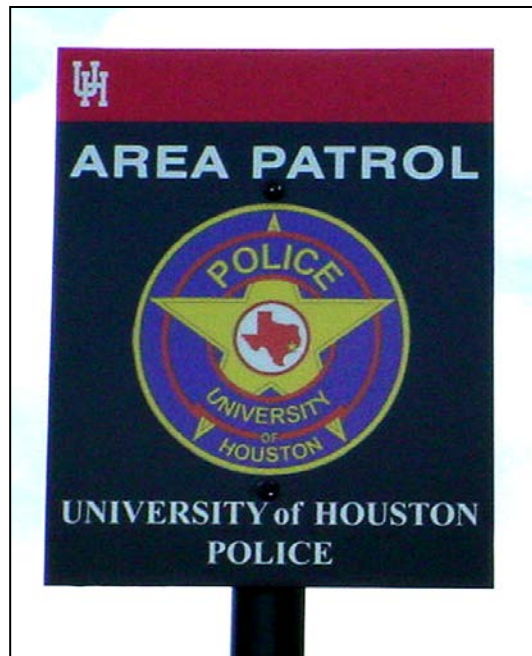


FIGURE 10.7
AREA PATROL SIGN

INFORMATIONAL GRAPHICS

Where informational graphics are required, high pressure graphic laminates may be used if submitted to and approved by the Campus Facility Planning Committee.

10.3. INTERIOR BUILDING SIGNAGE

10.3.1. Purpose and Scope

The interior signage program is a standardized signage program meeting the intent of the Texas Accessibility Standards (TAS) and the American's with Disabilities Act (ADA) signage requirements for interior spaces. Other regulating bodies' requirements or policies, such as UBC and Fire and Safety Codes, may not be fully addressed in these guidelines; a code expert should be consulted in the design of compliance and regulatory signage.

All buildings within the University of Houston Campus shall be provided with Building Directional Signage in accordance with these guidelines. **Interior signage colors and selected format shall be presented to the project team at the same time as the interior finishes.** Plant Ops FM Lock/Access Shop personnel will assist with developing a work request for replacement or additional signage. Department managers who authorize non-standard interior signage for their facilities assume the responsibility for the cost of replacement or additional signage.

All room numbers shall be approved by the FP&C Office of Facilities Information.

Signage issues outside the scope of these guidelines shall be addressed on a project-by-project basis with FP&C.

10.3.2. Signage Standard Overview

For full details of the interior wayfinding sign program please contact, Facilities Planning & Construction Planning Services Group at 713-743-8025. Please review the following overview of the signage program and the signage schedule at **Figure. 10.8**.

The signage program consists of acrylic signage in five (5) different colors: red, black, light gray, dark gray, and white. Typically, identifying signs will include a red number panel or accent field, but choice of colors from the standard palette may take into account existing signs in the area or discordant wall colors. Panels are modular for consistent edges when grouped. Fonts are Trade Gothic Bold No. 2, Trade Gothic Medium, and Trade Gothic Light, and letters are 5/8" in height or more depending on sign function.

Sign types include but are not limited to flush-to-wall-and flag-mounting, identifying, directional, paper insert, directory, compliance/hazard, evacuation, posted occupancy, and stairwell signage.

Prior to installation, installer shall examine substrates, areas, and conditions for compliance with requirements for installation tolerances and other conditions affecting performance of signage work. Substrate shall be cleaned of all bond-breaking materials and loose debris.

Install signs level, plumb, true to line, and at locations and heights indicated, with sign surfaces free of distortion and other defects in appearance.

Affix flush-mounted signs with manufacturer's standard high-bond, foam-core tape, 0.045 inch (1.14 mm) thick, with adhesive on both sides. Apply tape strips symmetrically to back of sign and of suitable quantity to support weight of sign without slippage. Keep strips away from edges to prevent visibility at sign edges. Place sign in position, and push to engage tape adhesive.

Installer shall provide all hangers, channels, rods and other miscellaneous support steel as necessary to support suspended signage and shall fasten support to the existing structure in such a manner as to not compromise its existing structural integrity or fire rating.

Room Identifiers - Life Safety - Regulatory

Fix versions
Permanent versions
Stackable versions



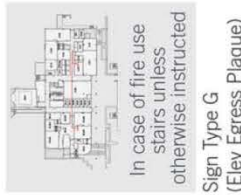
Sign Type B (Fixed Room Identification)



Sign Type C (Fixed Room Numbering)



Sign Type D (Clear View Sheet Holder)

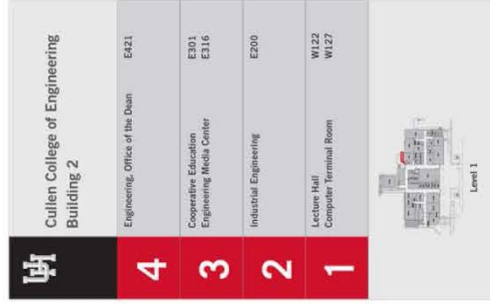


Sign Type G (Elev Egress Plaque)



Sign Type H (Egress Plaque)

Directory System



Sign Type I (Directory - Building)



Sign Type J (Directory - Dept)

Wayfinding



Double sided suspended directionals



Sign Type L (Wayfinding panel)



Sign Type M (Wall mount flag sign)

Wall mount flag signs

10.3.3. INDIVIDUAL ROOM SIGNAGE / ROOM NUMBERING AND IDENTIFICATION

A. Policy

Signs will designate all permanent rooms and spaces and comply with ADA requirements.

Every room shall have a room number. Semi enclosed spaces may also require room numbering; confer with Facilities Planning and Construction for project specific requirements.

Every department and suite of offices on a public corridor shall have identification along with a number. **Names of individual occupants shall not be included on any room sign.**

Signs for special use rooms, i.e., restrooms, stairwells, and the interior of stairwells, will include character / pictogram signs that comply with ADA.

10.3.4. BUILDING DIRECTORIES / MAIN ENTRANCE DIRECTORIES (Type 4 options a and b)

A. Policy

A wall-mounted building directory will be strategically located at or near the main entrance of every building.

Only administrative departments and academic units will be identified in the directory. No individual names will be included.

10.3.5. INDIVIDUAL FLOOR DIRECTORIES

A. Policy

A floor directory may be strategically located on each floor not considered the main floor of every building.

Only administrative departments and academic units will be identified in the directory. No individual names will be included.

10.3.6. COMPLIANCE SIGNS

A. Policy

The sign content and quantity of compliance signs (e.g. “No Entry,” “Employees Only,” “Maximum Occupancy _____,” “_____ Prohibited,” etc.) will be determined by Facility Planning & Construction and the department(s) involved. ISO graphic symbols shall be used (Sign Type 5) where applicable.

B. Sharps Signage

On the first floor of every building on campus, one public men’s room and one public women’s rest room shall feature both an approved Sharps container and exterior signage indicating Sharps disposal within. Contact the FPC or FS project manager for further information on the container and signage requirements.

10.3.7. EMERGENCY EVACUATION SIGNS

A. Policy

Certain occupancy types on campus shall contain emergency evacuation signs that illustrate the locations of all fire exits and the location of the viewer in relation to the fire exits. Each floor of an occupancy type listed below shall contain a minimum of one sign prominently placed in a public corridor. Additional signs shall be placed in any public corridor in which a ceiling or wall mounted exit sign is not visible.

Occupancy	Exit Diagrams Required
Classroom Buildings	No
Many of these include Auditoria) w/ >300 occupants	Yes
Hazardous Mtl Laboratories	No
Non-production Higher-ed Research laboratories	No
Charter School	No
Day Care (NFPA 101 separates educational and day cares into separate occupancies)	Yes
Student Housing Residential Flrs	Yes
Student Housing Facilities includg Dining Rooms or Commons >50 occup	Yes
Free-standing Dining Halls, >50 occupants	Yes
Indoor Athletic Space >49 occupants	Yes
Parking Garages	No
General Office	No
Retail Space	No
Clinics	No

10.3.8. STAIRWELL EMERGENCY EGRESS SIGNS

A. Policy

All stairwells on campus shall have buildings on campus shall have interior stairwell and occupancy side signage which meet Houston Fire Department and Texas Accessibility Standards requirements. The University of Houston Fire Marshal (Authority Having Jurisdiction) shall review and approve all stairwell signage.

10.3.9. PRODUCTION, INSTALLATION, MAINTENANCE, REPLACEMENT

A. Policy

All signage for capital improvement and major renovation projects shall be manufactured and installed in accordance with Design Guidelines Section 10.0 Wayfinding, by a sign manufacturer approved by Facilities Planning & Construction and under contract to the Project Consultant. Signage cost shall be charged to the construction budget.

All supplementary and replacement interior signage (due to minor remodeling, departmental moves, and reorganization) shall be manufactured and installed in accordance with Design Guidelines Section 10.0, Wayfinding. Requests for replacement and supplementary interior signage shall be directed to Facilities Maintenance via Work Request (<https://ssl.uh.edu/plantops/services/online-request/index.php>). Cost will be charged to the department or project budget.

Room numbers and departmental identification damaged due to vandalism or excessive wear will be replaced with signs meeting the current signage standards in Design Guidelines Section 10.0, Wayfinding at no charge to the department. Requests for such signage shall be directed to Facilities Maintenance via Work Request (<https://ssl.uh.edu/plantops/services/online-request/index.php>).

Specialized signage (e.g. directional or compliance) shall be initiated by Work Request from the department (<https://ssl.uh.edu/plantops/services/online-request/index.php>). Cost will be charged to the department.

10.4. GRAPHIC STANDARDS

Any use of the University of Houston's signature, logo, seal or other elements of the institutional identity program must comply with the requirements outlined in the UH Graphic Standards On-Line manual, which can be accessed by link through the web site of the Division of University Advancement, Office of University Relations at <http://www.uh.edu/policies/graphicstandards>.

SECTION 11.0

EXTERIOR LIGHTING DESIGN GUIDELINES

11.1 OVERVIEW

Inside its buildings and facilities the University of Houston desires to have a high quality of light suitable for the functions performed in each area while also achieving energy efficiency. By and large the design of this lighting is the responsibility of the designers of the individual project in accordance with the program requirements for each area.

Outside the buildings and facilities, UH desires to have a campus that is lighted so as to feel safe and secure to its nighttime users. These guidelines express the overall intent for lighting the campus; this intent is purposefully presented as a sequence of lighting that recognizes that safe and secure lighting levels vary with location, function, and adjacent influences. The sequence begins with street lighting for vehicular access and progresses to arrival in the parking lots. From the parking lots the sequence recognizes a lighting level for walkways adjacent to the parking lots that are influenced by the lighting in the lots and a lighting level for walkways farther away from the lots. The sequence proposes a lighting level for destinations such as building entrances and special places, as well as for landscaped areas adjacent to the walkways.

The UH recognizes that these lighting levels must flow from one to another and are not precise. The levels are indeed guidelines. However, it is the desire of the UH that the overall effect of all combined outdoor lighting works in a way similar to the lighting in the interior in that it is appropriate to each area so as to convey a sense of security and safety.

11.2 LIGHTING INTENSITIES

The brightest lighting intensity is typically found in the parking lots. This intensity is used as the basis for establishing all others.

11.2.1 Parking Lots

Lighting intensity for parking lots is described as follows:

Designation	Average	Maximum/Minimum	Minimum / Average
-------------	---------	-----------------	-------------------

Please also see Section 9.9.2 for additional criteria for parking lot lighting.

PL	6 fcs	8 : 1	4 : 1
-----------	--------------	--------------	--------------

11.2.2 Streets

Lighting intensities on UH streets should conform to those on public right of ways, or 1 to 1.5 foot-candles. This intensity is described as follows:

Designation	Average	Maximum/Minimum	Minimum / Average
ST	1-1.5 fcs	12 : 1	6 : 1

11.2.3 Walkways Crossing Streets

Lighting intensity for walkways crossing campus streets is described thusly:

Designation	Average	Maximum/Minimum	Minimum / Average
WS	4.5 fcs	8 : 1	4 : 1

11.2.4 Walkways Adjacent to Parking Lots

Walkways adjacent to parking lots (the first 100 feet) are the next brightest intensity at 2 to 3 foot-candles at the center of the walkway. This intensity is described as follows:

Designation	Average	Maximum/Minimum	Minimum / Average
WB	2-3 fcs	10 : 1-11 : 1	4 : 1

11.2.5 Walkways at Interior of Campus

Walkways away from the spillover influence of parking lot lighting are the "normal" level lighting intensity at 1.5 to 2 foot-candles at the center of the walkway. This intensity is described as follows:

Designation	Average	Maximum/Minimum	Minimum / Average
WN1	1.5-2 fcs	8 : 1	4 : 1

11.2.6 Walkways at Interior of Campus in Large Open Areas

Walkways away from the spillover influence of parking lots and in large open areas are another "normal" level of lighting intensity. This least bright intensity is described as follows:

Designation	Average	Maximum/Minimum	Minimum / Average
WN2	.75 fcs	8 : 1	4 : 1

11.2.7 Landscape Areas Adjacent to Walkways

Landscape areas within twenty-five feet of the walkways should be lighted to an intensity of 1.5 to 2 foot-candles so as to eliminate their appearance as dark islands. This intensity is described as follows:

Designation	Average	Maximum/Minimum	Minimum / Average
LA	1.5-2 fcs	8 : 1	4 : 1

11.2.8 Building Entrances

Building entrances are the destinations for most nighttime trips on the campus. They should be illuminated at an intensity of 6 to 9 foot-candles, so as to emphasize them to the pedestrian. The name of the building should be clearly illuminated as well. This lighting inside the building entrance should be designed so as to provide a transition to the lighting intensity at the building entrance outside. The entrance lighting intensity is described thusly:

Designation	Average	Maximum/Minimum	Minimum / Average
BE	6-9 fcs	n/a	n/a

11.3 LIGHT QUALITY

11.3.1 Color Spectrum

Lighting at walkways in particular must be "white" or the cool spectrum such as is necessary for distinguishing colors easily by eye and by remote security scanning cameras.

Pedestrian lighting at streets and walkways is gradually being retrofitted with LED lamps; all future pedestrian lighting shall be the University's standard pedestrian light fixture including LED lamp. Lighting at building entrances shall also be LED.

Parking lot illumination at the University of Houston is in a transitional phase between the traditional metal halide fixtures and preferred LED lighting. It is anticipated that a LED retrofit fixture adaptable to the current luminaire standard soon can be found and implemented in its place

11.4 CONTINUITY OF LIGHTING PERFORMANCE

Light pole bases have occasionally been knocked over, physically breaking the circuit and leaving areas of the campus without light. The University of Houston desires to further ensure functionality by individually fusing certain lights as follows:

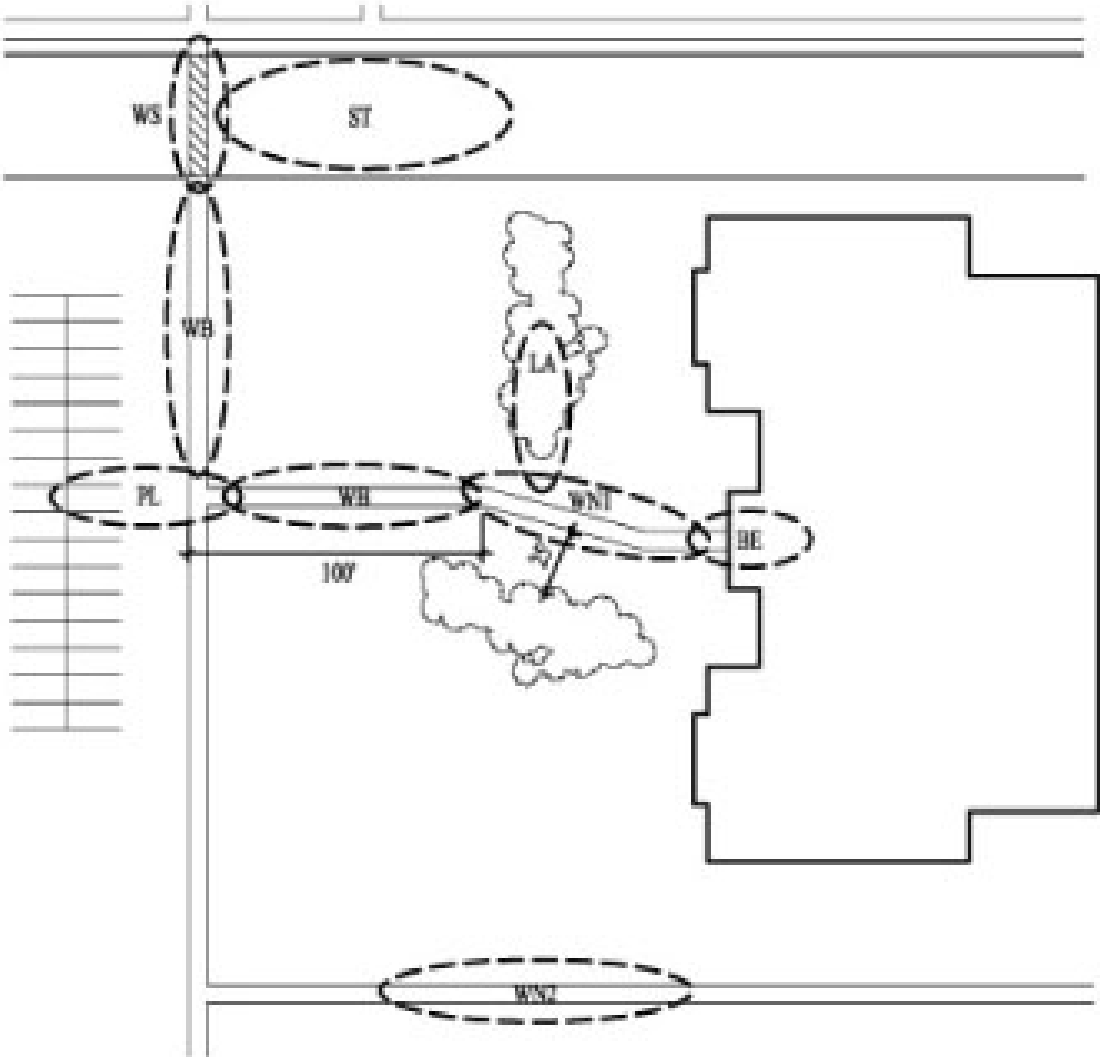
- All walkway lights, street lights, and parking lot lights shall be individually fused at each pole base. Fuses shall be Bussman HEB-JW-RLC-J with weather boot or UH –approved equal,

11.5 FIXTURE LOCATIONS

11.5.1 General Comments

- Architectural showcase lighting should not be used except for landmark or theme buildings. Even for these exceptions the lighting intensity should be as low as possible for the purpose.
- Lighting fixtures (especially flood lights) are not to be mounted on buildings except to illuminate the entrance, as described in **Section 11.2.7** above.
- Lighting fixtures should be carefully located and screened so as not to shine in the eyes of the pedestrian.

11.6 RELATIVE LIGHTING INTENSITY SEQUENCE DIAGRAM



SECTION 12.0

CONSTRUCTION SYSTEMS AND ASSEMBLIES STANDARDS AND GUIDELINES

INTRODUCTION

The University of Houston ("University" or "UH") expects and desires state of the art, "leading edge" design from the design consultants for its facilities. However, the design of the University's facilities must occur within certain desirable guidelines and meet certain standards. This section provides the guidelines and standards for the physical construction and systems of a project. The information is presented in the UniFormat style in order to facilitate initial estimates of construction cost.

The Office of Facilities Planning & Construction (FP&C) introduced master construction specifications in June 2011. FP&C intends that the standards and guidelines in this Section and the Master Construction Specifications be used in a complementary manner. Apparent conflicts between the standards and guidelines and the specifications shall be brought to the attention of the FP&C Project Manager, or submitted by email at <http://www.uh.edu/plantops/resources/owners-design-criteria/comment/>

All variations from these guidelines and standards must be requested in writing and approved in writing by the University Project Manager.

Please note that in several places there are references to other sections in the *University of Houston Campus Guidelines and Standards* document (such as SECTION 7.0 SUSTAINABLE DESIGN GUIDELINES, SECTION 8.0 SPACE STANDARDS AND GUIDELINES, SECTION 10.0 WAYFINDING STANDARDS AND GUIDELINES and SECTION 11.0 CAMPUS LIGHTING GUIDELINES).

FACILITY PERFORMANCE

The following is a fundamental description of the facility expected and desired by the University.

- A. Basic Function:
 - 1. Provide built elements and site modifications as required to fulfill needs described in the project program.
 - 2. The complete project comprises the following elements:
 - a. Substructure: Elements below grade and in contact with the ground.
 - b. Shell: The exterior enclosure, windows, sun screens, exterior doors, and roofing.
 - c. Interiors: Interior construction, stairs, finishes, and fixtures, except fixtures associated with services and specialized equipment.

- d. Services: Mechanized, artificial, automatic, and unattended means of supply, distribution, transport, removal, disposal, protection, control, and communication.
 - e. Equipment and Furnishings: Fixed and movable elements operated or used by occupants in the functioning of the project.
 - f. Site work: Modifications to the site, site improvements, and utilities.
3. Code: Make all portions of the project comply with "the code". The code referred to herein consists of all applicable local, state, and federal regulations.
- a. City of Houston review and permit is not required for projects on University-owned property. The University of Houston (State of Texas) is a sovereign authority. However, the design consultants will perform their work and design the project so that it would pass a City of Houston code review for permitting if submitted for such a review.
 - b. Criteria Documents: In addition to specific regulatory requirements, the following documents are also incorporated into the definition of "the code" for the purposes of this project. Except for administrative provisions contained therein, where referenced, the role of the code official described in the document will be performed by the University through the University of Houston System's ("System" or "UHS") Facilities Planning and Construction office ("FP&C").
 - c. Regulatory Documents:
 - i. City of Houston building, plumbing, mechanical and electrical codes with local amendments. Current versions are: 2012 IBC, 2012 Uniform Mechanical and Plumbing Codes, and 2014 National Electrical Code. The University uses NFPA Uniform Fire Code (**MAPP 07.02.01**).
 - ii. City of Houston construction standards for streets, storm and sanitary sewers
 - iii. National Fire Protection Association Life Safety Code 101, **2015**, with NFPA-72-**2015**. *Note: this edition is mandated by the State of Texas and has numerous referenced publications. **Attention is specifically drawn to the recent inclusion of NFPA 241-2013.***
The UH Fire Marshal's office is the officially designated Authority Having Jurisdiction (AHJ) over all Fire and Life safety-related issues. These are typically covered by NFPA or OSHA standards, as well as some municipal standards related to Houston Fire Department requirements.
 - iv. Texas Accessibility Standards and the Americans with Disabilities Act (ADA) Standards for Accessible Design; where standards disagree, the most stringent criteria shall be met.
 - v. Recognized design and construction standards such as National Electrical Code (NEC), American Society of Heating, Refrigeration, and Air Conditioning Engineers (ASHRAE), American Remodelers Institute (ART), Sheet Metal and Air Conditioning National Association (SMACNA), American Concrete Institute (ACI), Portland Cement Association (PCA), etc.
 - vi. Campus Design Guidelines and Standards. *Note: the technical standards included in this document may exceed those established in the codes*

referenced above.--

vii. State Energy Conservation Office Standards; ASHRAE/IESNA Standard 90.1-2013 with COH amendments; 2015 IECC with amendments

d. Where more than one code addresses the same subject, the more stringent code shall apply.

B. Amenity and Comfort

1. Thermal Performance: Design and construct to provide comfortable interior environment in accordance with the code and the following:
 - a. Summer Interior Design Conditions:
 - 1) Daytime Set point: 72° F.
 - 2) Interior Relative Humidity: 50%, maximum.
 - b. Winter Interior Design Conditions:
 - 1) Daytime Set point: 72° F.
 - c. Outside Air Design Conditions:
 - 1) Summer Outside Air Design Temperature: 95° F dry-bulb; 78° F wet-bulb.
 - 2) Winter Outside Air Design Temperature: 20° F dry-bulb. (target)
 - d. Energy Design Wind Speed: 25 mph (40 km/h).

C. Health and Safety:

1. Prevention of Accidental Injury: Design as required by code.
 - a. Safety Glazing: Provide in locations required by code, glazed areas subject to human impact, glazed areas at grade, and doors.
2. Flooding Hazard: Design to prevent harm to occupants or damage to structure, service, and contents due to flooding by rising water from Brays Bayou and to overland flow from the watershed above the campus.
 - a. Establish a "Project First Floor Elevation" on upstream side of site, which must be approved by FP&C. Refer to Section A1000.
 - b. Do not provide enclosed interior spaces below Project First Floor Elevation except where existing conditions require such space to connect to existing tunnels, as determined by FP&C.
 - c. Do not provide new tunnels except where existing conditions require such construction, as determined by FP&C.
 - d. Where a tunnel has been determined to be necessary, provide watertight structural separation of utility tunnel from connection to building below first floor level. Where personnel door is required through the separation, provide a watertight structural steel ship's hatch with linked battens at each side so the door may be opened or secured from either side.
 - e. Provide flood protection levees or walls at Project First Floor Elevation around all openings into building at grade that are below the Project First Floor Elevation, and outside of the building line, should such openings be determined to be necessary by FP&C.
 - f. Provide back flow preventing valves in all storm and sanitary sewer lines (both force and gravity) at building line. Provide access for easy maintenance of the

valves.

3. Lightning Hazard: Design to prevent damage to occupants, structure, services, and contents due to lightning strikes.
 - a. Provide protection equivalent to that specified in NFPA 780 (current edition) Supplementary strike termination devices, ground conductors, and grounding electrodes are required only where the integral portions of the structure cannot perform those functions.
 - b. Ground Resistance Measurement Methods: As described in NFPA 780 (current edition), Appendix I, or IEEE 81 (current edition).
 - c. Commissioning: Perform continuity tests for grounding conductors, equipotential bonding of other systems, and ground terminals; ground resistance test for each ground terminal, or equivalent taking into account related grounding systems.

4. Health Hazards:
 - a. Design to prevent growth of fungus, mold, and bacteria on surfaces and in concealed spaces.
 - b. Hazardous Construction Materials: Design and construct to comply with the requirements of the code.
 - c. Indoor Air Quality: Design and construct to comply with the code and the following: Acceptable air quality as defined by ANSI/ASHRAE 62 (current edition).
 - d. Commissioning: Field measure outside and supply air quantities for each space and its associated air handler.
 - e. Licensed architect shall provide written and sealed/stamped verification that all included specified materials are asbestos free.

Refer to SECTION 7.0 SUSTAINABLE DESIGN GUIDELINES

5. Physical Security: In addition to any provisions that may be required by law or code, design and construct both exterior and interior spaces to incorporate accepted principles of crime prevention through environmental design (CPTED), using natural (as opposed to technological) methods of providing surveillance, access control, and territorial reinforcement wherever possible.
 - a. Definition of Elements at Ground Level: For purposes of physical security, any element within 20 feet (6 m) of the ground, grade, or adjacent paving.
 - b. Security Zones:
 - i. Public Access Zone: That area to which the public has free access, including public corridors, grounds, and parking lots.
 - ii. Reception Zone: The area to which the general public has access but beyond which access is restricted at all times.
 - iii. Operations Zone: The area to which only employees and visitors with a legitimate reason to be there have access.
 - iv. Secure Zone: The area to which access is always controlled and which is monitored continuously.
 - c. See other Guidelines Sections for additional requirements.

Refer to SECTION 11.0 CAMPUS LIGHTING DESIGN GUIDELINES

6. Electrically-Operated Equipment and Appliances: UL listed for application or purpose to which they are put; suitable for wet locations listing for exterior use.

D. Durability

1. Expected Service Life Span: Expected functional service life of the built portions of this project is **50 years minimum**, unless otherwise indicated in the project program.
 - a. Service life spans of individual elements that differ from the overall project life span are defined in other Sections.

Foundation and Structure	50 years minimum
Roofing	20 years minimum
Exterior Cladding	approved hardware
35 years minimum	

Note: Brick, Metal Curtain Wall, Glass Curtain Wall, Precast Panels, and Stone Veneer meet this minimum.

Exterior Windows	30 years minimum
Exterior Doors	25 years minimum
Plumbing, Site	50 years (can last longer)
Plumbing, Domestic	30 years minimum
Sprinkler System	25 years minimum
HVAC	25 years minimum
Electrical Service	40 years minimum

2. Flood Resistance: The project is expected to stand fully operational in 3 feet of flood water as measured above the lowest first floor level allowed by code on the upstream side of the site. Refer to Section A1000.
 - a. At interiors below the Project First Floor Elevation, where determined to be necessary, provide interior construction and fixtures that are inherently water resistant.

E. Operation and Maintenance:

1. Space Efficiency: Minimize floor area required while providing specified spaces and space relationships, plus circulation and services areas required for functions.
2. Energy Efficiency: Minimize energy consumption while providing function, amenity, and comfort specified. Refer to SECTION 7.0 SUSTAINABLE DESIGN GUIDELINES.
 - a. All new construction or major renovation projects undertaken by state agencies and state supported institutions of higher education must comply with the State Energy Conservation Design Standards (Texas Administrative Code Title 34, Part I, Chapter 19, Subchapter C. Rule §§ 19.31-19.34), (Statutory Reference: Texas Government Code, § 447.004), (effective June 20, 2003) and applicable provisions of ASHRAE 90.1-2010.
 - b. A major renovation project is defined as a renovation or improvement that affects the energy or water use of the facility. For instance, a lighting project that requires engineering drawings would require certification, replacing lamps would not.

- c. Standard for public low rise residential buildings: the energy conservation design standard of the International Energy Code Council as published in the International Energy Conservation Code (current adopted version).
 - d. Certification: State agencies and state-supported Institutions of Higher Education must require that the design architect or engineer certify that the project complies with the Energy Conservation Design Standard and submit a copy of that certification to SECO prior to construction. The certification form can be found on the State Energy Conservation Office website, <http://www.seco.cpa.state.tx.us/>.
- 3. Water Consumption: Minimize water consumption. Refer to SECTION 7.0 SUSTAINABLE DESIGN GUIDELINES.
 - 4. Waste (Trash/Rubbish) Removal: Refer to Master Specification 017300 and 017700.
 - 5. Ease of Operation: Provide facility, equipment, and systems that are easily operated by personnel with little prior training for the specific activities.
 - a. Minimize the need for specialized training in operation of specific equipment or systems; identify all equipment and systems for which the manufacturer recommends or provides training programs.
 - b. Train University personnel in operation of equipment and systems.
 - 6. Ease of Maintenance: Minimize the amount of maintenance required.
 - 7. Ease of Repair: Elements that do not meet the specified requirements for ease of repair may be used, provided they meet the specified requirements for ease of replacement of elements not required to have service life span equal to that specified for the project as a whole; the service life expectancy analysis and life cycle cost substantiation specified for service life are provided; and University acceptance is granted.
 - 8. Allowance for Changes in Occupancy and Arrangement:
 - a. Office Spaces: Design for churn of less than 15 percent, requiring only occasional minor changes to individual workplaces or relocation of staff.
 - 9. Maintenance Materials: Attic stock requirements for finish and material items (such as paint, flooring, wall covering, rest room and door hardware, or other items that require specific color, pattern, or stylistic match) shall be as defined in individual Section 12 subcategories and Master Specifications documents. If not defined, attic stock quantity shall generally be 5% and in no case more than 5%. Replacement stock, that is, only non-standard items that are location specific, may be included in major construction projects in quantities of 1-2 %.
 - a. A Maintenance/Replacement Materials (Attic stock) submittal shall be included with other required project submittals. See Master Construction Specifications Form 00 60 00 ASF.
 - b. No paint, adhesive or chemical attic stock will be permitted. Contractor shall provide the final paint schedule in PDF format and in paper format with paint chips attached. Contractor shall also provide a list of sealers and stains used on

floors, tiles, and wood surfaces in PDF format and in paper format.

- c. No light bulb attic stock will be accepted unless specialty light bulbs have been installed.
- d. No left over parts like j-boxes, conduits, ceiling grids, etc. will be accepted.
- e. Acceptable attic stock items are listed in Master Construction Specifications Form 00 60 00 ASF.
- f. The percentage of attic stock to be supplied should be discussed with the FM supervisor of the zone in which the project is located as soon as the attic stock room size is known.

ELEMENT A

SUBSTRUCTURE

A10 FOUNDATIONS

A1000 GENERAL

- 1. To ensure the proper "Project First Floor Elevation", the design consultant is requested to set the floor elevation from interpretations of the existing and proposed finish grades and contours, after confirming proper drainage around the building, and referring to the applicable code. The design consultant is then directed to increase that floor elevation one foot to establish the "Project First Floor Elevation." In no instance shall the finished floor be less than one foot above the 100-year flood plain as established by TSARP. FP&C shall approve the Project First Floor Elevation.

A1010 STANDARD FOUNDATIONS

- 1. For occupied space at grade level, provide a structural slab over a void of sufficient depth to prevent expansion of earth resulting in pressure on the bottom of the slab. Provide precast soil retainer at perimeter grade beams to prevent soil intrusion. Apply concrete damp proofing to mitigate water vapor penetration. Exterior stairs and ramps for building occupants (not for maintenance purposes) shall also be structural slabs.
- 2. FP&C has traditionally required an accessible crawl space under portions of buildings where ongoing access to plumbing or other below grade systems may be required, such as at kitchens. The crawl space characteristics are a two (2)-inches thick, 2500 psi un-reinforced mud slab, properly sloped and drained; with lighting and ventilation. Minimum clearance shall be established by the Facility Authority but shall in no case be less than three (3)-feet minimum clear dimension. Crawl spaces shall have damp proofing at bottom of slab to mitigate water vapor penetration. The geotechnical engineer on the Project shall advise whether a crawl space may be included on a project.

A1020 SPECIAL FOUNDATIONS [NOT USED]

A1030 STANDARD SLAB ON GRADE

1. Non-structural slabs on grade may be utilized with FP&C approval in basements, maintenance/storage buildings, parking garages and other outdoor structures. All other non-structural slabs may only be used upon advisement of a licensed geotechnical engineer and with the approval of FP&C. Only FP&C will make these determinations on a project-by-project basis. For non-structural slabs on grades at conditioned spaces, a minimum 15mil ASTM E 1745, Class A vapor barrier shall be utilized.

A20 BASEMENT CONSTRUCTION: NOT ALLOWED

A2000 GENERAL

1. Basement construction, tunnels, and related slabs on grade are generally not allowed for new construction. There are existing basements and utility tunnels on the campus, and new projects may of necessity have to connect to these existing facilities. Only FP&C will determine these exceptions on a project-by-project basis. When such an exception is allowed, the new construction must safely stand alone in a flooding condition.

A2010 BASEMENT EXCAVATION

1. **Basements for habitation, storage, mechanical or electrical equipment are not allowed.** Utility tunnels and utility access basements will be approved by FP&C only as determined to be necessary by existing conditions.

A2020 BASEMENT WALLS

1. **Where basements are allowed,** provide all basement walls with waterproofing, protection board, drainage materials, French drains and geo-tech fabric.
2. **Where tunnels are allowed,** provide all tunnels with basement wall construction and floor slabs sloped for positive drainage to sump pits with pumps.

ELEMENT B

SHELL

B10 SUPERSTRUCTURE

B1000 GENERAL

1. Due to the characteristics of the energy source of powder-actuated fasteners, these tools pose potential health and safety hazards to the worker and the work area. The University of Houston prohibits the use of powder-actuated fasteners on new construction or renovation projects.

B1010 FLOOR CONSTRUCTION

1. Design floor structures on all major buildings to carry a minimum live load of 100lbs./s.f., unless greater is required by Code for a particular space function such as library shelving. This allows flexibility of future design when it may be renovated. Design floors to be sufficiently rigid to prevent objectionable vibration.

B1020 ROOF CONSTRUCTION

1. Traditional pitched roofs may be considered where appropriate to the building type, aesthetic design, and roof enclosure design. Refer to SECTION 5.0 ARCHITECTURAL DESIGN GUIDELINES.
2. Refer to section B3010 for low slope roof covering options.
3. Metal deck and concrete roof slabs for new buildings will be sloped by designing the pitch into the structural frame and not by using variable thickness insulation or other non structural assemblies. Design roof to slope from the center toward the exterior walls.
4. New construction minimum 1/4" per foot as per IBC requirements in any direction; this includes cross-slopes and crickets. Re-roof minimum IBC slope not required; zero slope variance.

B20 EXTERIOR ENCLOSURE. Refer to SECTION 5.0 ARCHITECTURAL GUIDELINES.

B2000 GENERAL [NOT USED]

B2010 EXTERIOR WALLS

1. When selecting exterior building materials, obtain approval from FP&C prior to proceeding with development of details. Final approval of desired exterior materials and color must be approved by FP&C.
2. Building design must comply with the latest ASHRAE 90.1 energy code. The design consultants are required to prepare and submit forms for compliance verification to Texas State Energy Conservation Office (SECO).

3. Choose low maintenance building materials; design for durability and to optimize material use.
4. Choose building materials with low embodied energy.
5. Exterior materials such as stucco, painted concrete, or colored porcelain are not allowed.
6. Per the Architectural Precast Concrete Sealant and Joint Guide, precast concrete panel joints shall have two sealant beads: a weather seal near the exterior face and an air/vapor barrier seal close to the interior face of the panel. The exterior weather barrier is designed to shed most of the water from the joint, and the interior air vapor seal is the demarcation line between outside and inside air pressure. Between the two joint sealants is an air cavity which must be vented and drained to the outside.

Air tightness of the air vapor barrier seal is critical, as is the sizing of the weather seal openings which govern the speed at which pressure equalization occurs. Pressure equalization must take place almost instantaneously for a joint to be effective.

Water in precast panel joints, either from penetration or condensation, should be drained from the joint by proper flashing or transverse sealant bead installations. The Guide advises using these flashing details as dampers to avoid vertical movement of the air in the joint chamber caused by wind, outside air turbulence and stack effect. Flashings using the sealant should be installed at regularly spaced intervals along the height of vertical joints, usually near the junction of the horizontal and vertical joints at each floor level. Therefore, if any moisture does come out of the system, it will run down the face of the joint sealant and not over the face of the panels.

Panel configurations and joint sizes should permit a careful applicator to successfully install both the air/vapor seal and the weather barrier from the exterior. The normal positions of the backing and sealant are reversed for the interior air seal. (*Architectural Precast Concrete Sealant and Joint Guide, www.cpci.ca*)

B2011 BRICK

1. Brick will be selected during project design and shall be specified in the bid documents.
2. The predominant brick color for use on the campus of University shall be buff (Acme PEP 30 dove gray w.k/s velour) as used at Calhoun Lofts, among other buildings.
3. The dark accent brick used at Calhoun Lofts, Acme DTP 153 Ebony with k/s velour may also be used as an accent on new buildings.
4. Other compatible brick choices with approval of FP&C/FM Core Team.

B2012 STONE AND CAST STONE

1. Cut stone shall be Cordova Cream Texas Limestone.
2. Cast Stone shall be mixed thoroughly dry as follows: One (1) sack Atlas White Portland Cement with one (1) oz. of Lambert Bright Yellow Color. After blending the above, use the following mixture: Four (4) parts "Big Sandy" sand to one (1) part of blended cement color mixture.
3. Stone should match stone on Ezekiel W. Cullen Building (west façade).
4. Use stainless steel accessories for attachment.
5. Use the Indiana Limestone Handbook as a detailing guide.

B2013 CONCRETE MASONRY UNITS

1. Use bull nose type concrete masonry units at all edges and exterior corners.
2. Provide damp-proofing behind all masonry.
3. Use of CMU for elevator shafts, mechanical, pump rooms and service docks is encouraged.
4. Provide vertical reinforcing rod in solid grout at all corners, end conditions and jambs.
5. Provide joints at each side of pilasters; use flexible ties to connect one joint to the continuous wall.

B2015 METAL PANELS [In Development]

B2017 EXTERIOR GRAPHICS

1. Building name signage shall be inscribed or surface-mounted in accordance with SECTION 10.0 WAYFINDING.
1. Building name shall be illuminated in accordance with SECTION 11.0 LIGHTING DESIGN GUIDELINES. Exterior and internal illumination of signs shall be reviewed by the Campus Facilities Planning Committee.
2. Each building shall have its street number posted on the building where it is visible to emergency vehicles. The street number shall contrast with its background and shall be visible at nights and during all seasons.
3. Dedication plaques shall be of incised stone or cast metal in accordance with SECTION 10.1.4.

B2020 EXTERIOR WINDOWS

Refer to SECTION 5.0 ARCHITECTURAL DESIGN GUIDELINES and SECTION 7.0 SUSTAINABLE DESIGN GUIDELINES.

1. Heads, jambs and sills of windows in walls shall be flashed and caulked or sealed during the window installation, prior to the placement of snap-on moldings or covers, to insure that concealed surfaces are properly sealed against the penetration of wind and water. All windows (including those with integral sill flashing) shall, subject to manufacturer's agreement, be installed above a sill pan with end dams. All windows should have drips at heads and sills.
2. If double-glazed windows are used, use thermal break aluminum window sections.
3. Projected, movable sash windows, casement type windows, and flush mounted windows are difficult to maintain watertight and their use is discouraged.
4. Design windows with maintenance in mind and include provisions for cleaning windows above third floor. Window washing and window replacement requirements need to be considered during design.
5. Skylights are discouraged. When they are approved, specify double-glazing, thermal breaks, interior gutters and insulated curbs.
6. Windows shall have transparent low-e energy efficient double-glazing. Other energy efficient glass such as frit screened or lightly tinted may be used when necessary to meet energy codes and when approved by FP&C. Highly reflective glass shall not be used. Since the adoption of ASHRAE 90.1-2010, the most commonly specified window glass on campus has been Solarban 70XL.

B2021 SUN AND GLARE CONTROL

1. Exterior: protect all glazed areas on the southeast, south, southwest, and west facades from direct exposure to the sun during all seasons.
2. Interior: Vertical window blinds are not acceptable. Provide Meco-Shade or Draper mechanically-operated shades at all windows in building envelope. Larger or inaccessible openings may require motorized operation. Contact FPC Project Manager regarding shade. Vertical window blinds are not acceptable color/texture/pattern. As shade width increases (typically over 9 ft./108 in.) reduce overall shade width by splitting one wide shade into two or more shades; or increase the tube diameter and add a horizontal batten for every roll width (6 ft./72 in.-8.5 ft./98 in.).

As the shade height increases (no range provided by manufacturer), combat the tendency for the shade edge to curl and wave by splitting the shade vertically into two or more shades; or increase the tube diameter and add a horizontal batten for every roll width (6 ft./72 in.-8.5 ft./98 in.). Note also effect of direct downlighting and adjacent ventilating air on shade aesthetics.

3. Provide mini-blinds or appropriate visual privacy treatment for offices, conference rooms and private spaces.

B2030 EXTERIOR DOORS

- a. Thresholds shall be no greater than 1/2" height and beveled. Use heavy-duty thresholds with maximum anchorage.
- b. Use thresholds and weather stripping at exterior doors to prevent air and water infiltration. Rain Guards shall be used on any exterior application with less than a two-foot overhang above the door.

1. Doors and Frames

- a. Exterior hollow metal doors are to be heavy duty galvanized, 18-gauge minimum with a 16 gauge minimum frame.
- b. Snap-in frames are not permitted on exterior doors.
- c. Exterior personnel doors shall not be larger than 7 feet high. Avoid use of single doors over 8 feet high and 3 feet wide.
- d. All general use entrances require a vestibule. Protect exterior doors with overhangs.
- e. All door glass and side-lights are to be laminated safety glass, except when wire glasses required in fire-rated doors and windows.
- f. Coordinate finish of metal frames with hardware or adjacent metal (i.e. specify bronze thresholds and bronze finish closers, if metal frames have bronze finish).
- g. Warning bars or cross mullions shall extend across all full height glazed areas. Meet requirement of "Model Safety Glazing Code" and "Consumer Product Safety Commission" and "Way Faring Guidelines".
- h. Provide 1/8" clearance around all sides of doors.
- i. All hardware shall conform and meet all ADA code requirements including installation.
- j. Aluminum framed glazed entrance assemblies shall not be less than heavy-duty wide style to receive locksets or panic hardware. Custom styled doors with vision panels may be used. Locksets and/or panic devices shall be at conventional height and are not permitted in bottom rails. Frameless glass doors are not allowed.
- k. Custom finishes on doorframes are not allowed.
- l. Single Point Latching is highly preferred.

2. Testing

- a. Ensure that windows, doors and louvers are designed for adequate wind loading and velocity pressures per code.

- b. All doors shall be tested for ADA Compliance.
- c. All doors shall be tested and adjusted following any air balancing.

3. Mullions

- a. Removable center mullions most commonly used on campus need to be approved by FP&C. Where approved, use key cylinder "Best 7-pin" lockable mullion.
- b. Key to Mullion will be issued to select persons who oversee the building and insure that the mullion is replaced once removal is needed.

B2031 EXTERIOR DOOR HARDWARE

1. Thresholds

- a. Use thresholds and weather stripping at exterior doors to prevent air and water infiltration. Rain Guards shall be used on any exterior application with less than a two-foot overhang above the door.

2. Approval Procedures

- a. All deviations from these guidelines must be requested in writing and approved by the Assistant VC/VP, Public Safety and Security including the UH Access Control Shop.
- b. Final keying will be coordinated and approved by the UH Access Control Shop. UH DPS must approve card access system.

3. Cores Existing Renovations

- a. Lock cylinders to accept Best Access Systems 7-pin IC cores—American type only. Contractor must provide construction cores. Door and mortise locks shall be Sargent 8200 Series.

4. Core New Build-Out

- a. Provide keyed brass construction cores and keys during the construction period. Construction control and operating keys and core shall not be part of the Owner's permanent keying system or furnished in the same keyway (or key section) as the Owner's permanent keying system. Permanent cores and keys (prepared according to the accepted keying schedule) will be furnished to the Owner.
- b. Provide Cylinders with removable and interchangeable core system: BEST CORMAX Patented 7-pin system. Provide endurance, attack resistance, and harsh environment key system protected by US utility patent 7,681,425 (expiration May 2027), which has controlled distribution through Stanley and/or its Authorized Distributors and requires authorization through Stanley Patented Masterkey System Security Authorization Form for sales and shipment of Stanley patented cores to individuals noted on the form. Patent is inclusive of cores certified to meet the security, safety, and reliability requirements of BHMA A156.5 Grade 1, and are

compatible with all existing SFIC interchangeable core housings, eliminating the need for new or modified locksets.

- c. Provide individually capped core pin chambers to minimize re-pinning labor.
- d. Provide Permanent keys and cores stamped with the applicable key mark for identification. These visual key control marks or codes will not include the actual key cuts. Permanent keys will also be stamped "Do Not Duplicate".
- e. Transmit Grand Masterkeys, Masterkeys and other Security keys to Owner by Registered Mail, return receipt requested. No other means of transmission will be permitted.
- f. Furnish Nickel silver keys and steel clips to ensure long and reliable operation.
- g. Furnish keys in the following quantities:
 - i. 1 each Grand Masterkeys
 - ii. 1 each Masterkeys
 - iii. 1 each Change keys each keyed core
 - iv. 15 each Construction masterkeys
 - v. 1 each Control keys
- h. The Owner, or the Owner's agent, will install permanent cores and return the construction cores to the Hardware Supplier. Construction cores and keys remain the property of the Hardware Supplier.
- i. Keying Schedule: a keying meeting, with the Owner and the Best Keying Specialist shall take place after the hardware supplier has ordered the keyed cylinders and locks. The Owner will verify the lock and exit devices are functionally correct and the keying complies with project requirements. The Mfg. will furnish three typed copies of keying schedule to the Owner.
- j. On renovation projects, the University of Houston Access Control Shop will determine keyway requirements for lock cylinders. Removal of existing cores shall be requested by a recoverable cost work request (<https://accessuh.uh.edu/index.php>). Existing University cores will be removed and set aside, and vendor supplied construction cores maybe installed by vendor, unless work in being completed by in-house workers which the UH Access Control shop will provide and install construction cores during the renovation process. Vendor supplied construction core, Vendor will provide the UH Access Control Shop copies of all keys or complete code list. UH Access Control Shop will replace the construction cores with the University cores after construction is completed unless UH Access Control shop direct vendor otherwise.

5. Hinges and butts

- a. Three hinges per leaf to 7 feet, 6 inch in height, add one hinge for each additional 30 inches in height, or fraction thereof.
- b. All doors over three feet in width will have heavy-duty ball bearing hinges also doors with panic or fire hardware devices.
- c. Out swing, exterior doors will be non-ferrous with non-removable pins (NRP).
- d. Non-ferrous material on exterior doors and at doors subject to corrosive atmospheric conditions.
- e. Provide shims and shimming instruction for proper door adjustment.

- f. All glass storefront type doors equipped with pivots shall have an intermediate jacking pivot set to correct the height of the doors.
 - g. All high traffic doors should be so equipped with a full continuous gear hinges.
 - h. Exterior doors shall have Grade 1 commercial heavy-duty pivots, commercial heavy-duty ball bearing butt hinges, or continues gear hinges.
6. Door Closers
- a. Use Sargent Model 351 door closers on exterior and interior doors with four (4) adjustments. Door closer must be securely mounted to the surface utilizing through-bolt.
7. Card Readers
- a. All new buildings shall provide electrified hardware on all exterior doors, and a minimum of two doors having card access with an approved automatic operator, both with key override and both integrated into the campus wide access control system (refer to D5040). Doors with Automatic operators (ADO) shall have both a proximity and magnetic strip format reader. All exterior doors shall be able to be secured & unsecured electronically from the DPS Communications Center. Specifications for special security locks must be reviewed and approved by UH Access Control Shop.
 - b. Hard-wired on-line locks are to use on all perimeter doors allowing access to interior of the building, and on occupancies space with 50 or more. Hard-wired locks have the fastest propagation delay to a lock-down order and therefore optimize security in areas exposed to greater risk. Exterior doors not providing access and only utilized for egress may have all exterior trim removed but shall have door contacts for position monitoring and REX on the egress side. Dummy cores may be installed to disable exterior hardware as an option to full removal and patching of the hardware set.
 - c. Hard-wired electrified hardware installations must have Von Duprin or series 80 Sargent exit devices (the campus standards). Wireless installations shall have Precision panic hardware for consistency throughout campus.
 - d. All perimeter doors must have request to exit function.
 - e. All perimeter doors shall have door position monitoring capabilities in a supervised mode.
 - f. Off-line Readers can only to utilize in spaces that are not normally occupied and that will always be operated without a time zone and in secured mode, such as storage, equipment rooms, etc. A maximum of twenty client-defined users are allowed. PIN codes shall only be allowed if the hardware is operated in dual validation mode. Restrictions on offline locks have been imposed because they cannot be controlled in a lock down situation. Furthermore, deactivation or addition of a user requires someone to visit the lock and download a new user list.
 - g. Mechanical or electronic PIN Code Locks should no longer be utilized. PINs are easily shared and there is no accountability of who may have received the PIN. All PIN Code locks will have to be replaces with card reader type electronic locks as funding is available.

- h. Wireless on-line locks can be used in occupancies of 49 or less. Space must normally be operated without a time zone and secured in card mode. Because of the propagation delay associated with a lock down order, wireless on-line locks should not be used on perimeter doors allowing access to interior corridors or tunnel system, or classroom doors to include laboratories.
 - i. Existing exterior doors will be retrofitted with electrified hardware as outlined above when buildings are remodeled, or as funding becomes available.
 - j. Demolition of all electric mechanical hardware on all doors shall be coordinated with FM Building Maintenance and FP&C before being discarded. All small parts shall be bagged and attached to the correct door/part.
 - k. At Student Housing Residential Life’s option, all common doors and doors to community spaces such as laundry, exercise, kitchens, and/or game rooms) shall have on-line hard-wired card reader systems. Private space may utilize off-line (“hotel style”) access control locks or wireless on-line locks. All other doors shall meet with all other design guidelines unless otherwise approved in writing by SHRL and UHDPS.
8. Automatic Doors (ADO)
- a. Automatic operating doors may be sliding or swinging, as appropriate to the building use and design, with safeguards and handicapped accessibility as necessary. Door types, materials, hardware, and sensors shall be established designs with proven field experience under similar usage. Preferred manufacturers are Horton for swinging doors, and Stanley or Record USA for sliding doors. Consideration shall be given to availability of trained serve technicians and spare parts.
 - b. Automatic doors are preferred in high traffic areas.
 - c. One automatic door opener (ADO) shall be located in a major entrance at the most used location along the accessible pathway or route. The second shall be located either by the loading dock or at the door closest to the parking lot used by building occupants after hours or weekends. See also card access requirements for automatic operating exterior doors below.
 - d. Automatic doors should be wired so that the unlocking and locking of the door is day mode function.
9. Finishes
- a. Door trim and hardware finish color shall match existing hardware (levers lock, etc.) in building.
 - b. All door handles shall be “P” handle type or return type.
 - c. All new finish hardware to be Satin Finish. Do not use polished finishes.
10. Approved Hardware
- a. Mortise deadbolts must be Sargent and must conform to fire/life safety code. Interior handle must retract deadbolt in one action. All machine rooms, custodial closets, telephone rooms, elevator machine rooms, mechanical rooms, and electrical rooms must have door closers and self-relocking. (Storeroom Function).

- b. Use Sargent 80 Series or comparable Von Duprin exit devices (panic hardware). Custom panic devices are not allowed. Do not use concealed vertical rods for panic hardware. Surface mounted vertical rods are recommended.
 - c. Surface vertical rods are permitted and encouraged at loading dock doors only as long as rod and latch guards are installed. Single Point latching panic bars should be first choice of design and where applicable. Allow space between the door head and the ceiling for maintenance and repair.
 - d. Avoid use of active/inactive leaf doors with coordinators when other hardware can be used to meet fire codes. Key removable mullions acceptable.
 - e. Kick plates shall be specified for inside of exterior doors.
 - f. Use floor mounted doorstops to prevent wall damage.
 - g. All Panic Devices should be mounted to each door utilizing the through-bolting method wherever applicable. End Caps and covers must be secured to the brace with security screws.
 - h. It is recommended that classroom doors be equipped with a single side lock-down deadbolt with thumb turn that can “lock down” the room in the event of emergency from inside the room. Egressing the space shall be possible by pressing or turning the door knob/lever (single action) or by releasing the inside thumb turn. Access to this space shall be accomplished by key when deadbolt is engaged. The card access system will be de-activated if deadbolt is activated.
11. Rollup doors.
- a. Operation - Operation Type: Motor type
 - b. Curtains - Material: The curtain shall consist of 18 gauge (.047 minimum steel thickness) steel interlocking slats. Steel slats shall be roll-formed from commercial quality hot-dipped galvanized (G-90) steel per ASTM A-653.
 - c. Finish/Color:
 - i. The curtain shall be finished in Gray: as normally-provided, one coat white epoxy primer and one top coat of gray polyester paint.
 - d. Endlocks:
 - i. Lateral movement of the slats to be contained by means of zinc-plated malleable cast-iron endlocks fastened with two zinc-plated steel rivets.
 - e. Bottom Bar and Seal:
 - i. Bottom bar shall be two roll-formed galvanized steel angles, minimum 1 ½” x 1 ½” x 1/8” (38.1 mm x 38.1 mm x 3.2 mm). Bottom astragal shall be single-contact type. Structural angle bottom bar shall receive one coat of rust-inhibitive primer
 - f. Wind load:
 - i. Doors shall be designed to withstand 20 pounds per square foot (87.64 kg/sq.m.) wind load.
 - g. Vision Panels:
 - i. Rolling service door may be furnished with 4” x 1” (101.6 mm x 25.4 mm) Plexiglas vision panels, 1/8” (3.2 mm) thick for flat and large curve slats and 5/8” (15.9 mm) for insulated flat slat with quantity and locations detailed on door elevation drawing (delete this section if not applicable).

- h. Curtain Wear Straps.
 - i. Rolling service door may be furnished with polyester wear straps to discourage the curtain from premature wear resulting from coiling of the door (delete this section if not applicable).
- j. Jambs Mounts
 - i. Steel Jambs: as normally-provided, and supplied with self-tapping fastener.
 - ii. Wood Jambs: as optionally-provided, and supplied with lag bolt fasteners.
 - iii. Masonry Jambs: as optionally-provided, and supplied with anchor bolt fasteners.
- i. Weather Seal: Rolling service door may be provided with guide brush seal or snap-on vinyl seal.
- k. COUNTERBALANCE SYSTEM
 - i. Counterbalance: The curtain shall be counterbalanced by means of torsion Spring: as normally provided, consisting of oil-tempered, helical torsion springs, grease packed and mounted on a continuous steel torsion shaft or Weight Counterbalance: as optionally-provided, for promoting high cycle life durability.
- l. HARDWARE
 - i. Lock: Rolling service door may be provided with a lock cylinder lock that accepts a SFIC cylinder: as optionally provided and available for use with hand chain, and hand crank operated doors (motor operated doors will require an interlock switch with the SFIC cylinder lock).
 - ii. Door shall be provided with door position contact and remote down relay to be tied into the card access system (BASIS) for remote closing of door.
 - iii. All safety devices shall interrupt remote closing until safety is cleared then door should resume closing process.

B30 ROOFING

B3000 GENERAL

- 1. When replacing existing or adding on to existing roofs, review the original design thoroughly before making any change in type of roofing to be used. **NOTE:** For any new or renovated roof projects that involve the use of asphalt or urethane materials, the contractor must submit Material Safety Data Sheets (MSDS) to the University upon project completion.

B3010 ROOF COVERINGS

Refer to SECTION 5.0 ARCHITECTURAL DESIGN GUIDELINES

- 1. Traditional pitched roofs of standing seam metal or clay tile or curved roofs of standing seam metal are encouraged.
 - a. Provide double lock standing seam roof design. Snap caps are not allowed. Design to SMACNA requirements.

- b. Standing seam roofs should be used only when there is sufficient slope and the design is simple. The design should have no penetrations. If dormers are used the design should be such that the entire dormer assembly is simple and covered by the roofing warranty.
 - c. Provide clay tile design and specification to meet or exceed "Ludowici" installation requirements.
 - d. Standing seam and clay tile slopes will be sloped per manufacturer's recommendation.
2. The University's preferred low slope roofing systems include a hybrid single ply system and a high-tier modified bitumen system. A utilitarian grade modified bitumen system may be allowed in certain instances. Refer to the Master Specifications Division 07.
- a. Recent roofing industry reporting advised that torch and hot asphalt applied roofing have superior bonding over cold applied roofs. Once cool, torch and hot applied roofs do not emit VOC's (Volatile Organic Compounds) into the air. Cold asphalt adhesives, however, contain solvents that are high in VOC's. After installation approximately 50% of the pails' content of cold asphalt adhesive evaporate into the air.
 - b. All low-slope roofs will have a minimum 1/4" per foot slope or greater if required by manufacturer's warranty.
3. Roof Accessories
- a. Elevated roof expansion joints are required.
 - b. Scuppers: Size and locate roof scuppers to carry water off in the event of roof drain stoppage. Size scuppers large enough to float out empty soft drink cans. Scuppers are preferred in lieu of overflow drains.
 - c. Pipe Supports: Non-ferrous, non-corrosive type as recommended by roof manufacturer for proper pipe support and weight distribution on roof; supports shall provide unbinding thermal expansion/contraction movement of piping without jeopardizing warrant ability of roof system. Set supports on additional wearing surface of cap sheet layer or walk-pad material.
 - d. Equipment Supports: As recommended by both the roof system manufacturer and the equipment manufacturer. Equipment curbs and base flashing must be at least 8" high.
 - e. Walkways: To prevent damage to roof areas around equipment maintenance access areas, mop down a walkway layer of 90 lb. cap sheet over installed cap sheet. The 90 lb. cap sheet walkways to roof mounted equipment and around access hatches are to be 3 feet wide. Provide walkway pads at high and low

step-offs at each roof ladder and entrance ways to roof. Other walkway systems to be acceptable must be approved by University of Houston.

4. Slope

The roof must slope to the drains. Refer to Section B1020.4.

- a. Secondary slopes and crickets to roof drains may be sloped with tapered insulation.
- b. Roof structure is required to be sloped in B1020. Meet "Factory Mutual 90" design criteria unless directed otherwise.
- c. Tops of equipment curbs shall be level in all directions.
- d. Roof hatch tops shall slope to drain.
- e. Copings shall slope towards roof minimum 1" across width for drainage.

5. Roof designs and detailing will be reviewed and accepted for warranty purposes by manufacturer's engineers prior to issue for bidding.

6. Galvanized metal flashing is not allowed. Aluminum or stainless steel is recommended.

7. Pitch pans are not allowed. Flash or boot all roof penetrations.

8. Aluminum cap flashing, or standing seam profile coping (or stone coping assembly design to be approved by FP&C) is required on top of parapets.

9. Breather vents in roofing systems are not allowed.

10. Pitch and spray-on foam type roofs are not allowed.

11. Design roof to minimize roof penetrations. Design to limit roof mounted equipment. Encourage design of vents and intakes to be in vertical walls, not as roof penetrations.

12. Lightweight concrete insulating fill roof decks will not be allowed. Lightweight structural concrete is allowed.

B3020 ROOF OPENINGS

1. All roofs over one story will have access by stair or roof-hatch. Provide lockable hatch with Best cylinder.

ELEMENT C

INTERIORS

C10 INTERIOR CONSTRUCTION

C1000 GENERAL

1. Required Spaces
 - a. Donor Signage Area.
 - i. Design consultant shall propose interior wall space near the main entry to allow for donor recognition signage.
 - b. Custodial Storage Room and Requirements
 - i. A storage room is to be 8'x12'. Do not locate storage room next to trash room
 - ii. Custodial requirements for offices and classrooms
 - For office trash receptacles, use SAFCO SAF-9616 BL.
 - For classroom trash receptacles, use SAFCO SAF-9618 BL.
 - c. Trash Room.
 - i. Trash rooms shall not be provided in classroom and office buildings due to problems with odors and pest infestation.
 - ii. Trash room locations in other buildings shall allow for maneuvering of large refuse carts in and out of the space. If trash room door is inset, corner protection at adjoining walls shall be provided. The trash room door shall be oversized or otherwise allow for a full 36" clear opening. In addition, the trash room door shall feature a magnetic door holder which releases the door to close upon fire alarm signal.
 - d. Recycling Rooms (On Each Floor)
 - i. A recycling room for storage of recyclable materials is to be a minimum of 8'x8'. Locate adjacent to or close to the Custodial Closet.
 - ii. New construction shall include on each floor recycling alcoves sized to enclose a minimum 96 gallon size wheeled recycling container. Recycling alcoves shall be coded X041 for incorporation into sustainability metrics. Recycling alcoves may not be located along egress corridors for the following reasons: Recycling bins in an alcove in an exit corridor do not meet code for the following reasons: bins are light and can be moved, when bins are full occupants will continue to pile recyclables in and around the bins obstructing egress; and were the bin to catch fire it would produce enough smoke and heat to prevent occupants access to, egress from, or visibility of the means of egress.

e. Attic Stock Room.

- i. Provide an attic stock room (minimum 8' x 8' in size) for storage of maintenance or replacement finish materials. Locate adjacent to or close to Custodial Storage or main mechanical room.

2. Floor and Room Number Assignment and Identification.

a. Floor and Space Identification Systems.

Contact Facilities Information regarding current numbering protocols

- i. Each space shall be identified by room name and number.
- ii. Room numbers used in the Construction Documents will become the actual and permanent room numbers.
- iii. Proposed numbering system will be approved by FP&C.

b. Assignment of Floor Numbers

- i. The floor level containing the primary entrance shall be considered the First Floor and shall be numbered in the 100 series; the floor above being the Second Floor shall be numbered in the 200 series.
- ii. Third and subsequent floors shall be numbered in a similar manner.
- iii. Below grade levels, if allowed, shall be numbered in the 001 series.

c. Assignment of Room Numbers

- i. The rooms on each floor opening off a corridor shall be numbered consecutively in a clockwise direction from the primary entrance, which shall be X00.
- ii. Rooms and spaces not opening off a corridor shall carry the room number of the connecting room with an additional suffix letter (108A, B, C, etc.). Letter clockwise, if more than one room is involved.
- iii. Stairwells should be labeled and floor numbers posted on inside of doors in accordance with NFPA 101.

-Note: Room number 420 shall be avoided.

d. Assignment of Door Numbers

To allow integration of lock shop data into FAMIS, doors on floor plans shall be assigned numbers based on the room which the hardware serves. Hardware on a typical office door located, say, between corridor 100 and Office 112, should be assigned the number 112. An interior closet in Office 112 will also include the 112 in the lock number series. Exterior doors shall be numbered consecutively along the perimeter of the building.

-Format shall be

Building number - room number - number (1, 2, 3, etc., based on primary and secondary doors) - space use suffix.

Example for a door to an interior room:	585-112-01-IN
Example for a door to a smaller room within an interior room:	585-112-02-IN
Example for a door between corridors:	585-102-01-CR
Example for an exterior door opening onto Lobby 100:	585-100-01-EX
Example for a door into stairwell A:	585-A103-01-ST

3. Acoustical Quality/Vibration Control
 - a. Analyze each space or room for the purpose of insuring acoustical quality and vibration control.
 - b. Room acoustics and control of mechanical noise and vibration is a requirement of the design consultant’s standard professional service.
 - c. The design consultant is charged with achieving a good educational environment in his design product to include educational spaces, offices, and corridors.
 - d. Noise Criteria (NC) figures for different spaces should be as follows (based on ASHRAE Handbook Systems Volume, Latest Edition).

Space	Criteria
Offices	NC-35
Executive Offices	NC-30
Lecture Rooms	NC-30
Major Lecture Halls	NC-30
Auditoriums	NC-30
Corridors	NC-45
Classrooms	NC- 35
Laboratories	NC- 40
Libraries	NC-30

- e. Acoustical performance of general usage partitions should be equal to or greater than the following Sound Transmission Class (STC) ratings (based on Uniform Building Code 1997 and U.S. Dept. of HUD requirements):

Partitions dividing	Criteria
General Offices	STC-40
Executive Offices	STC-50
Classrooms	STC-50
Corridors	STC-50
Lecture Rooms	STC-55
Mechanical	STC-55
Conference Rooms	STC-55

- f. Some partitions may require greater acoustical attenuation to achieve a given NC performance rating in a space depending on specific situations; for example, a partition separating a mechanical room and lecture room.

- g. Lecture room and lecture halls should have an average reverberation time that is less than or equal to one second for frequencies between 500 and 2000Hz.

C1010 PARTITIONS

1. Partitions enclosing corridors, mechanical, electrical and restrooms are permanent and require more substantial construction than secondary partitions. Include STC and fire rating in the partition schedule.
2. Use metal studs. Sixteen inches (16”) stud spacing is required. Size gauge for span and load.
3. Wet walls are required to be cement board.
4. Where abuse of wall surfaces is anticipated gypsum board walls will be composite cement board or glass fiber reinforced gypsum.
5. Gypsum board walls are required for all general purpose applications. Consider installing fire-rated gypsum board (Type X) for all installations even if not technically required.
6. Wall should extend from floor to structure.
7. Do not use masonry load-bearing walls as partitions.
8. Do not use 2 inch solid plaster partitions.

C1020 INTERIOR DOORS

1. Standards for interior doors are 3 ft. wide by 7 ft. high, solid wood core, stained (preferred) or plastic laminate finish.
2. Except for fire-rated doors, use lumber core doors only. Particle board cores are not acceptable. Door faces to be paneled wood or wood veneer.
3. Avoid use of single doors over 8 feet high and 3 feet wide.
4. Pocket doors and folding doors shall not be used without approval of FP&C/FM.
5. Small wire glass vision panels (8 inches by 33 inches) in metal frame in doors to laboratories, classrooms, conference rooms, offices or any space where flammable or combustible material is to be used are recommended.

6. Use 3-piece aluminum door jambs except as required by fire codes for labeled doors.
7. Do not use knock down hollow metal door frames in new construction.
8. All door glass and side-lights to be laminated safety glass, except when wire-glass is required in fire-rated doors.
9. Provide 1/8 inch clearance around all sides of doors.
10. Do not use removable center mullions for doorways.
11. Corridor doors to open out.
12. All doors that are specified to have electric mortised locks shall be factory prepped with an electrical raceway from the hinge to the lock and shall be so noted on the construction documents hardware schedule.
13. All electrical rooms shall have a panic bar and a panic bar through all other exiting door(s) where an injured person may receive rescue. Door(s) shall be fire rated for 1 ½ hours.
14. All high voltage vaults shall have a panic bar and a panic bar through all other exiting door(s) where an injured person may receive rescue. Door(s) shall be “labeled” fire rated for 3 hours.

C1025 INTERIOR DOOR HARDWARE

1. Thresholds
 - a. Thresholds on handicapped accessible routes shall be no greater than ½” high and beveled.
 - b. Use heavy-duty thresholds with maximum anchorage.
2. Approval Procedures
 - a. All deviations from these guidelines must be requested in writing and approved by the Assistant VC/VP, Public Safety and Security including the UH Access Control Shop.
 - b. Final keying will be coordinated and approved by the UH Access Control Shop. UH DPS must approve card access system.
3. Cores Existing Renovations
 - a. Lock cylinders to accept Best Access Systems 7-pin IC cores—American type only. Contractor must provide construction cores. Door and mortise locks shall be Sargent 8200 Series,

4. Core New Build-Out
 - a. Provide keyed brass construction cores and keys during the construction period. Construction control and operating keys and core shall not be part of the Owner's permanent keying system or furnished in the same keyway (or key section) as the Owner's permanent keying system. Permanent cores and keys (prepared according to the accepted keying schedule) will be furnished to the Owner.
 - b. Provide Cylinders with removable and interchangeable core system: BEST CORMAX Patented 7-pin system.
 - c. Provide key system protected by US utility patent 7,681,425 (expiration May 2027), which has controlled distribution through Stanley and/or its Authorized Distributors and requires authorization through Stanley Patented Masterkey System Security Authorization Form for sales and shipment of Stanley patented cores to individuals noted on the form.
 - d. Provide endurance, attack resistance, and harsh environment resistance.
 - e. Provide A second, independent locking mechanism that utilizes a patented set of built-in side pins to provide higher security. Cores will only operate when the proper keys are inserted to disengage the patented built-in side pins from the body and sleeve.
 - f. Provide cores certified to meet the security, safety, and reliability requirements of BHMA A156.5 Grade 1.
 - g. Provide cores that are compatible with all existing SFIC interchangeable core housings, eliminating the need for new or modified locksets. Provide individually capped core pin chambers to minimize re-pinning labor.
 - h. Provide Permanent keys and cores: Stamped with the applicable key mark for identification. These visual key control marks or codes will not include the actual key cuts. Permanent keys will also be stamped "Do not duplicate."
 - i. Transmit Grand Masterkeys, Masterkeys and other Security keys to Owner by Registered Mail, return receipt requested.
 - j. Furnish Nickel silver keys and steel clips to ensure long and reliable operation.
 - k. Furnish keys in the following quantities:
 - i. 1 each Grand Masterkeys
 - ii. 1 each Masterkeys
 - iii. 1 each Change keys each keyed core
 - iv. 15 each Construction masterkeys
 - v. 1 each Control keys

- l. The Owner, or the Owner's agent, will install permanent cores and return the construction cores to the Hardware Supplier. Construction cores and keys remain the property of the Hardware Supplier.
 - m. Keying Schedule: a keying meeting, with the Owner and the Best Keying Specialist shall take place after the hardware supplier has ordered the keyed cylinders and locks. The Owner will verify the lock and exit devices are functionally correct and the keying complies with project requirements. The Mfg. will furnish three typed copies of keying schedule to the Owner.
 - n. On renovation projects, the University of Houston Access Control Shop will determine keyway requirements for lock cylinders. Removal of existing cores shall be requested by a recoverable cost work request (<https://accessuh.uh.edu/index.php>). Existing University cores will be removed and set aside, and vendor supplied construction cores maybe installed by vendor, unless work in being completed by in-house workers which the UH Access Control shop will provide and install construction cores during the renovation process. Vendor supplied construction core, Vendor will provide the UH Access Control Shop copies of all keys or complete code list. UH Access Control Shop will replace the construction cores with the University cores after construction is completed unless UH Access Control shop direct vendor otherwise.
5. Hinges and butts
- a. Three hinges per leaf to 7 feet, 6 inch in height, add one hinge for each additional 30 inches in height, or fraction thereof.
 - b. All doors over three feet in width will have heavy-duty ball bearing hinges or doors with panic or fire hardware devices.
 - c. Out swing, interior doors will be non-ferrous with non-removable pins (NRP).
 - d. Non-ferrous material on exterior doors and at doors subject to corrosive atmospheric conditions.
 - e. Provide shims and shimming instruction for proper door adjustment.
 - f. All glass storefront type doors equipped with pivots shall have an intermediate jacking pivot set to correct the height of the doors.
 - g. All high traffic doors should be so equipped with a full continuous gear hinges.
 - h. Interior doors shall have Grade 1 commercial heavy-duty pivots, commercial heavy-duty ball bearing butt hinges, or continues gear hinges.
6. Door Closers
- a. Use Sargent Model 351 door closers on interior doors with four (4) adjustments. Door closer must be securely mounted to the surface utilizing through-bolt. Floor type and overhead-concealed door closers are not acceptable.

7. Card Readers

- a. Hard-wired on-line locks should be used on all interior spaces of the building with occupancies space with 50 or more. Hard-wired locks have the fastest propagation delay to a lock-down order and therefore optimize security in areas exposed to greater risk. Interior doors not providing access and only utilized for egress may have all exterior trim removed but shall have door contacts for position monitoring and REX on the egress side. Dummy cores may be installed to disable exterior hardware as an option to full removal and patching of the hardware set.
- b. Hardwired electrified hardware installations must have Von Duprin or series 80/82 Sargent devices (the campus standards). Wireless installations shall have Precision panic hardware for consistency throughout campus.
- c. All doors with card reader must have request to exit function.
- d. All doors with Card reader shall have door position monitoring capabilities in a supervised mode.
- e. Off-line Readers may only be utilized in spaces that are not normally occupied and that will always be operated in a secured mode. (No auto unlocking) such as storage, equipment rooms, etc. A maximum of twenty client-defined users are allowed. PIN codes shall only be allowed if the hardware is operated in dual validation mode. Restrictions on offline locks have been imposed because they cannot be controlled in a lock down situation. Furthermore, deactivation or addition of a user requires someone to visit the lock and download a new user list.
- f. Mechanical or electronic PIN Code Locks should no longer be utilized. PINs are easily shared and there is no accountability of who may have received the PIN. All PIN Code locks will have to be replaces with card reader type electronic locks as funding is available
- g. Wireless on-line locks can be used in occupancies of 49 or less. Space must normally be operated in a secured mode (no automatic unlocking). Because of the propagation delay associated with a lock down order, wireless on-line locks should not be used on perimeter doors allowing access to interior corridors or tunnel system, classroom or laboratories.
- h. Demolition of all electric mechanical hardware on all doors shall be coordinated with FM Building Maintenance, FP&C, UH Access Control Shop, and UH Access manager before being discarded. All small parts shall be bagged and attached to the correct door/part.
- i. Special design for Student Housing. All common doors and community used space such as laundry, exercise, kitchens, and/or game rooms) shall have on-line hardwired card reader systems. Private space may be design to utilize Off-line hotel style function access control locks. Although wireless on-line locks maybe a more accommodating design. All other doors shall meet with all other design guild lines.
- j. Specifications for electrified security locks must be reviewed and approved by UH Facility Management and The Electronic Access Control Manager. All electrified hardware will be coordinated with the "Cougar Card" system and shall integrate with the campus wide access control system.

- i. All new classroom doors shall be equipped with electrified hardware and a minimum of one (1) card access lock with key override, which can be opened and secured electronically from the DPS Communications Center. Card reader shall be set up on “first card unlock.” All egress only doors from the classrooms shall have door position and REX function for monitoring in BASIS.
- ii. All residential buildings shall have card access doors with key override at the following locations: Interior ingress/egress doors, building living/common areas (including laundry and fitness rooms, etc.), first floor elevators, first floor doors connecting public space to bedroom wings, first floor stairwell doors, upper floor common areas (such as computer rooms, fitness areas, and computer rooms), doors leading into bedroom suites, and individual bedroom doors. Hallway doors leading into single residential rooms will also be equipped with card access locks. Card access hardware shall not include keypads. Hotel style function off-line card reader maybe used on bedrooms and suite doors leading to bedrooms.
- iii. Research areas shall have at their primary entries card access doors with key override. Within the research area, electrified hardware and readers shall only be installed on doors that have high security concerns.
- iv. Clinical treatment areas shall have card access doors with key override.
- v. Pharmacies and pharmaceutical storage areas shall have card access doors with key override.
- vi. Administrative/office suite doors shall have card access with key override to enter the suite. Individual offices inside the suite and off public hallways will not have card access unless there is a need for accountability of access or a large number of users needing access.
- vii. MDF, IDF, and Mechanical/Electrical Rooms shall have card access doors with key override.
- viii. Double leaf doors and that are electrified and used for public ingress to the facility will have all leaves electrified.

8. Automatic Doors (ADO)

- a. Automatic operating doors may be sliding or swinging, as appropriate to the building use and design, with safeguards and handicapped accessibility as necessary. Door types, materials, hardware, and sensors shall be established designs with proven field experience under similar usage. Preferred manufacturers are Horton for swinging doors, and Stanley or Record USA for sliding doors. Consideration shall be given to availability of trained serve technicians and spare parts.
- b. Automatic doors are preferred in high traffic areas.

9. Finishes

- a. Door trim and hardware finish color shall match existing hardware (levers lock, etc.) in building.
- b. All door handles shall be "P" handle type or return type.
- c. All new finish hardware to be Satin Finish. Do not use polished finishes.

10. Approved Hardware

- a. Mortise deadbolts must be Sargent and must conform to fire/life safety code. Interior handle must retract deadbolt in one action. All machine rooms, custodial closets, telephone rooms, elevator machine rooms, mechanical rooms, and electrical rooms must have door closers and self-locking. (Storeroom Function).
- b. Use Sargent 80 Series or comparable Von Duprin exit devices (panic hardware). Custom panic devices are not allowed. Do not use concealed vertical rods for panic hardware.
- c. Surface vertical rods are permitted. Single Point latching panic bars should be first choice of design and where applicable. Allow space between the door head and the ceiling for maintenance and repair.
- d. Avoid use of active/inactive leaf doors with coordinators when other hardware can be used to meet fire codes. Key removable mullions acceptable.
- e. Kick plates shall be specified for inside of interiors doors where trash, push, tool carts are utilized.
- f. Use floor mounted doorstops to prevent wall damage.
- g. All Panic Device should be mounted to each door utilizing the through-bolting method wherever applicable. End Caps and covers must be secured to the brace with security screws.
- h. Classroom door maybe equipped with a manual lock down deadbolt that can be utilized in the event of emergence from inside the room by the turn a thumb turn on the lock. Egressing the space can always be done by pressing or turning the inside door knob/lever. Single action only. Access to this space will be accomplished by key when deadbolt is activated. Deadbolt can also be unlocked with the inside thumb turn. Due to design card access system will be de-activated if deadbolt is activated.
- i. Contractor to purchase Best lock cylinders and combined cores to be delivered to UH Access Shop.
- j. New construction projects, Best will deliver lock cylinders and combined cores to the UH Access Shop. Keyway requirements for lock cylinders will be determined by Best and UH for each building and coordinated with UH Access Shop.

11. Rollup doors

- a. **In Development**

12. Electrical Rooms and Electrical Vaults

- a. All electrical rooms shall have a panic bar and a panic bar through all other exiting door(s) where an injured person may receive rescue. Door(s) shall be fire rated for 1 ½ hours.
- b. All high voltage vaults shall have a panic bar and a panic bar through all other exiting door(s) where an injured person may receive rescue. Door(s) shall be "labeled" fire rated for 3 hours.

C1030 ACCESS CONTROLLED EGRESS DOORS

- 1. Doors in the means of egress shall be permitted to be equipped with an approved entrance and egress access control system, if the following criteria are met.
 - a. Sensor release devices: A sensor shall be provided on the egress side and arranged to detect an occupant approaching the doors, and the doors shall be arranged to unlock in the direction of egress upon detection of an approaching occupant or loss of power to the sensor. Sensor release devices must be used in conjunction with a panic bar.
 - b. Manual release devices: Doors shall be arranged to unlock in the direction of egress from a manual release device located 40 in. to 48 in. (102 cm to 122 cm) vertically above the floor and within 5 ft. (1.5m) of the secured doors. The manual release device shall be readily accessible and clearly identified by a sign that reads as follows: **PUSH TO EXIT**. When operated, the manual release device shall result in direct interruption of power to the lock-independent of the access control system electronics, and the door shall remain unlocked for not less than 30 seconds.
 - c. Activation of the building fire-protective signaling system, if provided, shall automatically unlock the doors in the direction of egress, and the doors shall remain unlocked until the fire-protective signaling system has been manually reset.
 - d. Loss of power to the part of the access control system that locks the doors shall automatically unlock the doors in the direction of egress.

C1040 INTERIOR GRAPHICS

- 1. Refer to SECTION 10.0 WAYFINDING STANDARDS, 10.2 INTERIOR SIGNAGE.
- 2. Final room numbers are to be assigned to the rooms on all documents from the beginning of the project. The room numbering procedure recommended by the Texas Higher Education Coordinating Board will be used. FP&C must approve the room numbering plan. Refer to Section C1000.

C1050 ACCESSORY REQUIREMENTS

Refer to SECTION 8.0 SPACE STANDARDS AND GUIDELINES.

CUSTODIAL CLOSETS (ON EACH FLOOR)

1. Locate sink near door. Use receptor/floor sink with 12 inch high sides and splash guard 24" above sink.
2. Provide six mop hangers above the mop sink. Provide six broom hangers along one wall.
3. Provide on one wall four 12" deep shelves mounted 18" apart with the bottom shelf two feet above floor.
4. Provide above broom hangers two shelves with one located 52 inches above the floor and the second located 72 inches above the floor.
5. Provide a three foot (3') wide door opening outward into the corridor. Provide custodial master lock established for campus.

CUSTODIAL STORAGE ROOM

1. A storage room is to be 8'x12'. Do not locate storage room next to trash room.

TRASH ROOM

1. Trash rooms shall not be provided in classroom and office buildings due to problems with odors and pest infestation.

RECYCLING ROOMS (ON EACH FLOOR)

1. A recycling room for storage of recyclable materials is to be a minimum of 8'x8'. Locate adjacent to or close to the Custodial Closet.
2. New construction shall include on each floor recycling alcoves sized to enclose a minimum 96 gallon size wheeled recycling container. Recycling alcoves shall be coded X041 for incorporation into sustainability metrics. Recycling alcoves may not be located along egress corridors for the following reasons: Recycling bins in an alcove in an exit corridor do not meet code for the following reasons: bins are light and can be moved, when bins are full occupants will continue to pile recyclables in and around the bins obstructing egress; and were the bin to catch fire it would produce enough smoke and heat to prevent occupants access to, egress from, or visibility of the means of egress.

CUSTODIAL REQUIREMENTS FOR OFFICES AND CLASSROOMS

1. For office trash receptacles, use SAFCO SAF-9616 BL.
2. For Classroom trash receptacles, use SAFCO SAF-9618 BL.

ATTIC STOCK ROOM

1. Provide an attic stock room (minimum 8' x 8' in size) for storage of maintenance or replacement finish materials. Locate adjacent to or close to Custodial Storage or main mechanical room.

C1060 REST ROOMS

1. In all permanent buildings, toilet partitions or stalls should be floor-mounted with continuous head rail and shall be of phenolic or textured stainless steel construction. Partition panels shall fasten at wall with a full height "U"-bracket. Provide coat hook and bumper guard on back of each toilet partition door. Lever door hardware is required in handicapped-accessible stalls and preferred in all stalls. Specify all fittings as stainless steel for long-lasting quality.
2. Floor-mounted toilet stalls of metal with epoxy paint may be used in low usage areas. Provide combination hook and coat hook/bumper inside.
3. Where showers are provided, shower walls shall be masonry with ceramic tile finish. Shower pans shall be prefabricated lead; no rubber pans will be allowed.
4. Minimum size of ceramic wall tile to be 4-1/4" x 4-1/4". Light shades of tile should be selected for both floors and walls.
- ~~5. Sanitary napkin receptacles are required in each water closet enclosure or stall in women's toilet room.~~
6. Mirrors above ganged lavatories shall be full width of the lavatory installation.
7. Mirrors above single lavatories generally shall be 20" x 26" first quality plate glass mirror with chromium-plated brass or stainless steel frame and a 4 inches deep shelf, zinc coated pan backs, and theft-proof concealed mounting.
8. Lavatory counters are to be granite or Corian with self-rimming counter top sinks. Counters must be handicapped accessible. Install soap dispensers to drip into sinks.
9. Coordinate with FP&C regarding the current toilet tissue holder specification.
10. Sanitary napkin receptacle to be United Receptacle URI-13.
11. Hand dryers shall be Xlerator Model XL-SB. Paper towel dispensers shall not be installed in new construction and/or renovation projects. The use of rubber floor mats below hand dryers is required at all locations. Contact the FPC or FS project manager for standard mat information to be provided by the project on new

installations. Locate hand dryers close to sinks to reduce the water drip trail from the sink to the dryer.

12. Use Buckeye International Symmetry hand soap dispenser (Smoke color w/sym logo).
13. On the first floor of every building on campus, one public men's room and one public women's rest room shall feature an approved Sharps disposal container. Contact the FPC or FS project manager for further information on the container and signage requirements.
14. FP&C/FM-approved substitutes may be used for above accessories.
15. Provide floor drains in each toilet room near water closets and slope floor to drain. Provide one floor drain in each accessible stall.

C1062 INDIVIDUAL OCCUPANT REST ROOMS

Rest room facilities on the lowest floor of public buildings shall include a single occupancy rest room sized to be fully accessible to a wheelchair-dependent user and attendant. The single occupancy rest rooms do not require toilet/urinal partitions but otherwise shall be furnished with fixtures and accessories as directed in C1060. The rest room shall also include a diaper changing station.

C1065 LACTATION ROOMS

The University of Houston wishes to support students, staff, and faculty who are new mothers and who wish to breastfeed their babies; to that end the University has provided multiple lactation rooms across campus to meet the needs of nursing mothers. Design consultants shall consult with FP&C, the Women's Resource Center Director, and the building user regarding whether incorporation of a lactation room in planned remodeling or new construction enhances the lactation room program or is unnecessary due to an existing nearby location.

Design consultants shall refer to AIA Best Practices on Lactation Room Design for relevant planning guidelines.

C1070 BULLETIN BOARDS, TACK BOARDS, CHALK AND WRITE BOARDS

1. Directory and bulletin board location, size, and style must be approved by the FP&C Project Manager.
2. Use mechanical fasteners to mount marker and other type graphic boards to walls.
3. Provide chalkboards and/or white boards in all classrooms and conference rooms.
4. White boards are to be of three component type with porcelain enamel on 24 gauge steel face with rigid core and aluminum sheet backing. Finish shall be high gloss and shall be easily cleanable with dry cloth or standard eraser.

5. Provide bulletin boards and tack boards adjacent to administrative offices.

C20 STAIRS

C2000 GENERAL

C2010 STAIR CONSTRUCTION

1. Stairs used only for exiting will be designed to code and NFPA 101 requirements.
2. Stairs used for exiting but also used for student movement will be oversized or widened to accommodate the peak student loads.
3. Stairs used for students should use oversized structure and heavier gauge materials to reduce noise and vibration.

C2020 STAIR FINISHES AND FITTINGS

1. Fire exit stairs may have minimum finish requirement.
 - a. Student-used stairs will have rubber treads and landings to reduce impact noise. On stair treads wider than six feet no piece of rubber tread shall be less than one-third the tread width.
 - b. Student-used stairs will be brightly lighted and will use upgraded building finishes.
 - c. Provide acoustical treatment at all stair ceilings and on the underside of landings.
2. Handrails
 - a. Handrail simple and compound curves shall be formed by bending members in jigs to produce uniform curvature for each repetitive configuration required. Cylindrical cross section of member shall be maintained throughout entire bend without buckling, twisting, cracking, or otherwise deforming exposed surfaces of handrail and railing components.
 - b. The University of Houston Fire Marshal's Office enforces NFPA 101-7.2.2.4.2; Continuity: Required guards and handrails shall continue for the full length of each flight of stairs. At turns of new stairs, inside handrails shall be continuous between flights at landings."
 - c. Anchors and inserts as required to support work specified, in accordance with approved shop drawings. If required, provide reinforcement to meet loading criteria.
 - d. Depending on occupancy type, the handrail configuration may require, by code, a minimum finger recess.

C30 INTERIOR FINISHES

C3000 GENERAL

C3010 WALL FINISHES

1. In lobbies and major traffic corridors use durable, easily maintained materials such as stone, masonry, metal or plastic laminate. In unusually high-traffic areas, Scuffmaster Armor or Scrubmaster paint may also be considered.
2. In auditoriums and large classrooms use plastic laminate wainscot with stretched fabric acoustic panels above.
3. In all low-wear area, paints shall typically be non-VOC formulation
4. In classrooms, offices and corridors use semi-gloss or eggshell paint. Paint must be water-based unless exceptions are approved by FP&C/FM. High gloss and flat paints are not allowed. Paint shall be ICI, Sherwin-Williams, or UH Paint Shop approved equal.
5. Do not use vinyl wall coverings unless FP&C/FM approval is obtained prior to design. The use of vinyl wall covering is not allowed on the interior surface of exterior walls.
6. **Off-white and accent paint color standards:** At the conclusion of construction and renovation projects, large quantities of unused paint are left for disposal. Standardizing on a palette of off-white and accent color allows FPC/FS to combine remainder quantities and donate to UH departments or to non-profit organizations. Approved off-white paint colors are Sherwin-Williams SW6147 Panda White and SW7008 Alabaster. Contact your FPC or FS Project Manager for the full approved interior off-white and accent paint palette.
7. Do not use multi-colored enamels.
8. Refer to the appropriate sections for finishes in restrooms, stairs, janitor closets, electrical and telecommunications rooms.
9. Use corner guards on exterior corners of corridor walls and similar heavy traffic areas. Wall bumpers and corner guards are required adjacent to service elevators and loading docks.
10. In mechanical rooms apply a coat of paint to all surfaces that do not already have a finish coat of paint, such as pumps and motors. Vinyl-faced fiberglass panels installed to the ceiling and walls are recommended for acoustical absorption.
11. All renovation projects require UH Paint Shop approval of surface preparations before repainting.

12. UH Paint Shop must approve painting specifications.

C3020 FLOOR FINISHES

1. Provide walk-off mats or walk-off carpet tile at all entry vestibules.
2. Provide terrazzo, terrazzo tile, stone or porcelain flooring for all ground level entry lobbies and major traffic corridors.
3. Use stone or terrazzo base with stone or terrazzo floor.
4. Provide VCT for all high use areas that need hard flooring
5. Resilient tile floors (VCT): University standard thickness is 1/8 inch minimum.
6. Modular carpet shall be used for all carpet installations. Only broadloom may be used in office suites and other areas as approved by FPC/FM.
7. Carpet pads may be considered for deans' and executives' offices as approved by FPC/FM.
8. All rubber base to be 4" cove base at hard flooring and 4" straight base on carpet. Black-Brown is the preferred color option. FPC must approve any other color.
9. Use padded carpet in deans' and executives' offices as approved by FPC/FM.
10. Carpet tile may be used in classrooms and office areas as approved by FPC/FM.
11. Use stone or terrazzo base with stone or terrazzo floor.
12. All other base to be 4" black rubber cove base.
13. Mechanical room floor shall typically be sealed concrete for dust control. All exposed concrete is to be sealed. Mechanical rooms above occupied space shall have a sealed and watertight floor. The wall finish shall also be sealed and watertight for a minimum of four inches measuring from the floor. Four inch high concrete curbs are strongly recommended in mechanical rooms.
14. Custodial room floors shall be sealed concrete only.
15. Resilient tile floors (VCT and rubber): University standard thickness 1/8 inch minimum.
16. Seamless flooring is not encouraged except in laboratory and food service areas, as appropriate. Obtain approval by FPC/FM before use.

17. Computer flooring: 3 inch or 6 inch computer flooring may be applicable in server rooms and offices supporting computer labs. Ramps are not allowed. Recess the structure to obtain level transitions.
18. Wood flooring is not encouraged.
19. Laboratory floor finishes (all floors must be sealed to prevent leakage to lower floors):

Instructional labs flooring shall be VCT.
Research lab flooring for chemistry, physics, and engineering shall be VCT.
Research lab flooring for biology shall be monolithic, seamless, chemical-resistant vinyl flooring with integral coved based and mylar finish.
Greenhouse and animal holding flooring shall be monolithic epoxy resin.
Sealed concrete may be considered for alternate lab and storage area flooring.

C3030 CEILING FINISHES

1. All mechanical and electrical devices located above the ceiling must be accessible through a lay-in ceiling or access panels.
2. Ceilings of high humidity rooms will be plaster, drywall or plastic-clad lay-in panels.
3. Partitions will penetrate lay-in ceilings unless approved by FP&C.
4. Acoustical lay-in ceiling shall be 2 feet by 2 feet grid. Wire hangers shall be 12 gauge steel at four feet on center minimum. The hangers shall be wrapped tightly with three full turns.
5. Gypsum plaster ceilings will be limited to entry lobbies, decorative ceilings for auditoriums, and large conference rooms.
6. Fabric covered insulated panels may be used in auditoriums for acoustical control when installed to a taped and floated suspended drywall ceiling.
7. Drywall ceilings will be 5/8" fire-rated gypsum board on suspended 25 gauge metal studs at 16 inches on center.
8. Projector screens, and projector platforms will have independent support and will not bear on the ceiling framing system.

ELEMENT D

SERVICES

D10 CONVEYING

D1000 GENERAL

D1010 ELEVATORS AND LIFTS

The American Society of Mechanical Engineers/American National Standards Institute safety code for elevators, dumbwaiters and escalators, and moving walks, A17.1, latest edition shall be used in the selection and design. Elevators shall comply with current provisions of the Texas Department of Licensing and Regulations Architectural Barriers Texas Accessibility Standards and the Americans for Disabilities Act ("ADA") Accessibility Guidelines.

1. All elevator acceptance testing, including load test, is to be witnessed and approved by UH elevator maintenance staff.
2. The elevator vendor must include required training in the cost of the elevator and describe what training will be provided. Two complete sets of maintenance manuals are required. No proprietary special tools are allowed for elevator maintenance
3. Elevator controls for all elevators shall be Virginia Controls, Motion Control Engineering controls, or SmartRise controls only. Proprietary controller can be installed only if a non-proprietary compatible (as above) controller is provided to Elevator maintenance staff. Any additional components necessary to the removal of the proprietary controller and installation of the non-proprietary controller shall be provided to the elevator maintenance staff. For example: fixtures, electronic boards, door operators need to be non-proprietary components and need to be approved by UH Elevator Maintenance.

Non proprietary equipment is equipment that can be maintained by all elevator maintenance companies not just the manufacturer. Schindler , Otis , and Thyssen Krupp are examples of proprietary companies that have restrictions on their own elevator controls.

4. All elevators shall have remote monitoring capability in the controllers.
5. The elevator vendor must provide a priced spare parts list with prices good for at least three years after warranty period. Vendor must indicate availability of spare parts.
6. Elevator controls to have fire alarm panel control input for Fireman's Service-Phase I Recall to main entrance floor.
6. Elevator shafts are to be ventilated, but not excessively so that door operating problems result. Sump pumps are required in the pits.
7. Each elevator pit is required to have an access ladder, light, and duplex 120volt GFCI receptacle. The switch for the light is to be located at the top of the ladder. Provide

sump pit, sump pump with piping to adjacent elevator door and movable 55-gallons barrel.

8. Each elevator car top is to have a trouble light and duplex 120 volt GFCI receptacle.
9. Design elevator installations to comply with ADA. Specify directional (up or down) arrows above each door on the lobby side and provide gong or chimes.
10. Provide ADA-compliant emergency telephone system for each elevator in accordance with the following specifications:
 - a. One flush-mounted telephone: TALK-A-PHONE ETP-100EB
 - b. One ADA nameplate set.
 - c. One Rolm telephone adapter.
 - d. One analog telephone pair terminated in an RJ-11 jack and located near the elevator traveling cable at the telephone is required.
 - e. One telephone pair in elevator traveling cable and one assigned elevator telephone number from UH telecommunications from 48 volt analog board are required.
 - f. An emergency phone should be installed in the car operating panel. The emergency phone pushbutton should be installed 42" a.f.f.
13. Electric operated elevators are preferred; however, oil hydraulic operation may be considered where use is intermittent or where elevator serves three or fewer floors.
 - a. Hole-less technology shall be used for hydraulic elevators.
 - b. Hydraulic elevators shall be equipped with a submersible pump and power pack to lower cars to egress floor.
 - c. Elevator shafts with the potential for hydraulic fluid leaks shall have secondary containment as a built-in feature to prevent releases of fluid into the ground.
14. Machine-room-less elevators are not allowed.
15. Hydraulic elevators proposed for open buildings such as parking garages high traffic use shall have oil cooling units provided for each elevator.

PASSENGER ELEVATORS

Speed: 2 through 3 floors travel of 150 ft./min.;
 4 and above floors travel of 350 ft./min.;

Capacity: Generally, capable of holding an EMS stretcher and a load rating of 2500 to 3500 pounds are specified depending on floor area and person density.

Control: Selective/collective automatic for single cars. For multiple units of two or more, group automatic control. Solid state controls preferred. Virginia Controls only.

Operation: Leveling with resistance operation through 150 ft./min.; solid state control for 200 ft./min. and above.

Cab: All cab interiors shall feature stainless steel front car door, stainless steel base, luminous ceiling with UL approved, recessed LED lighting, exhaust fan, stainless steel handrails on three sides, steel toe rail where heavy cart or furniture moving is anticipated, telephone for voice communication to meet handicapped requirements.
Floor and wall panel finishes vary by quality level. See UH Project Manager for standard elevator palette specifications.

Utility level finish

utility cab textured stainless steel wall panels per palette specifications, commercial quality diamond steel floor plate flooring

Lowest level finish:

passenger cab Continuous full height plastic laminate panels, 3/16" terrazzo tile floor, all per palette specifications. Suggested for short-duration installations.

Standard level finish

passenger cab Plastic laminate panels above handrail height, textured stainless steel wall panels below handrail height, 3/16" terrazzo tile floor: all per palette specifications.

Upper end level finish

passenger cab Textured stainless steel wall panels above and below handrail height, 3/16" terrazzo tile floor: all per palette specifications.

Hoist way Entrances: 3'-6" min. width, 7'-0" high, baked enamel finish, power operation. Entrances shall be constructed of 16 gauge material.

Machine Location:

Electric Elevators: Overhead preferred, but location at lower level optional on installations of four floors and less.

Oil Hydraulic

Elevators: Not above first floor; adjacent to hoist way preferred.

Platform: Size according to code for capacity; however, standard sizes should be selected.

- Signals: Provide EPCO Door open bell, in-use light and illuminating buttons, EPCO braille markings on car operating face plate and call signals. One emergency alarm bell button in each car shall be connected to emergency alarm station at main floor.
- Flooring: Same as adjacent area by flooring subcontractor.
- Floor Lockout Provisions: Provisions shall be included if directed by FP&C.
- Emergency Power: Interlock with emergency generator if Emergency Power System is approved for building. At least one elevator in each building must operate on emergency power. Hydraulic elevators shall have switchable selection for emergency service.
- Hooks & Pads: Hooks shall be installed in all passenger elevators. In addition, one complete set of pads shall be furnished for the Owners' use after construction.

SERVICE ELEVATORS (Freight only)

- Speed: Up to and including 2 floors travel of 150 ft./min.; above 2 floors travel 350 ft./min. (traction version only).
- Capacity: Minimum of 4000 pounds; however, product and product weight should be considered.
- Control: Same as for passenger elevator operation except for a 2- floors installation a single automatic pushbutton will be acceptable.
- Operation: Same as passenger service.
- Cab: Standard freight (steel wainscoting) 8' high x 8' deep. Freight elevators are to be provided with complete set of wall protection pads.
- Hoistway/Entrances: Bi-parting type. Generally, door operation is manual; however, consideration should be given to power operation where use of equipment is extensive. Freight elevators are to have horizontal center opening doors. Freight elevator cabs are to be specified in detail. Entrances shall be constructed of 16 gauge material.
- Signals: EPCO Door open bell, in-use light and illuminating buttons.
- Machine Locations: Same as passenger elevators.

Platform: Size and classification according to code, building requirements, and capacity.

D20 UTILITY PIPING SYSTEMS

D2000 GENERAL

1. Pipes penetrating exterior walls below grade must be properly installed to prevent breakage due to building settlement or expansive soil.
2. All connections to campus distribution systems or public utilities shall be precisely located by dimension or coordinates and documented on "as built" drawings. Depth of piping shall be shown and inverts will be shown at manholes and other critical points.
3. Drop type entries shall be utilized per acceptable standards.
4. Access shall be provided to all working parts of plumbing devices. Do not permanently seal in wall any plumbing items requiring periodic operation or maintenance.
5. Provide 30 inch diameter minimum size access openings for all manholes.
6. Interior cleanouts shall be located at each bend and every 50 ft. in straight runs. Access panels (9" x 9" minimum) shall be provided at all cleanouts. Exterior cleanouts shall be located at every 90 ft in straight runs and shall be provided with a marked cover.
7. Consideration shall be given for easy access to grease traps, which must be serviced regularly.
8. New buildings constructed with campus tunnel access should allow for air-conditioning condensate recovery thru dedicated lines with venting where necessary.

D2010 PLUMBING FIXTURES

1. Provide custodial closets with receptor/floor sink with 12 inch high sides located near door.
2. In renovation projects, replacement fixtures shall match the manufacturer, style, rough-in, and mounting of existing fixtures.
3. In phased projects, fixtures installed in later phases shall match the manufacturer, style, rough-in, and mounting of fixtures installed in the first phase.
4. All urinals and water closets shall be wall mounted on fixture chairs attached to the floor.
5. Drinking fountains shall be electric, wall type, surface mounted in wall recess. Mount all bubbler spouts 36" above finished floor to meet handicapped requirements. Where two (2) fountains are mounted side by side, they shall be

mounted at different heights, one for handicap, and one standard. Provide bottle-filler style water fountains at all first floor electric drinking fountain installations.

6. Fixtures with enhanced water –saving characteristics may be considered for LEED-certified project. Contact the UH project manager for details.
7. AirJet Showerheads (281-859-9888) are the standard for campus showerheads.
8. No hub couplings, pipe, and fittings are not allowed.
9. Plant Operations preferred plumbing fixture manufacturers: see Master Construction Specification Section 22 30 00 Plumbing Fixtures.

D2010.90 EMERGENCY SHOWER & EMERGENCY SHOWER/EYE WASH COMBINATION UNITS

1. Emergency showers and emergency shower/eye wash combination stations shall be located so that an individual should be able to access them within 10 seconds. Floor drains shall not be provided. Each station shall be provided with a flow switch tied into the SimplexGrinnell's controls and network system and reporting to DPS and the Fire Alarm Shop as a priority 2 alarm.

D2015 PIPE INSULATION

1. All water piping insulation to be closed cell type (cellular glass or polyethylene).
2. Air handler condensate drain lines to be insulated along their entire length with Armaflex or equal.
3. Domestic cold and hot water lines are to be insulated.
4. Protective aluminum jacket required for pipe insulation in mechanical rooms.
5. Insulation joints to be sealed to prevent air and moisture absorptions.
6. Steam and condensate piping to be hydrous calcium silicate ASTM C533. Install with 16 gauge stainless steel tie wire or stainless banding on 9 inch centers with twisted ends.
7. Insulation thickness for steam piping: 1 ½ inches for pipe size up to 4 inch and 2 inches for pipe 4 inch and larger.
8. Jacketing: Aluminum jacketing 0.016 inch minimum thickness; stucco embossed with moisture barrier attached; longitudinal slip joints and 2 inch laps; aluminum or stainless steel metal jacket bands ½ inch wide and 0.015 thick minimum. All butt joints to be sealed with silicone. Manufactured fitting covers shall be used for all fittings.

9. Shields for insulation support at pipe hangers to be Grinnell Figure 167 or equal approved by FP&C. Shields must be attached to hanger or to the insulation jacket so as to not be able to fall.
10. All insulation material must be certified to be asbestos free.

D2020 DOMESTIC WATER DISTRIBUTION

1. General
 - a. Building HVAC design must comply with the latest revisions of the Energy Conservation Design Standard for New State Buildings. Project Architect and Project Engineer shall prepare and submit forms for compliance verification.
 - b. Solar water heating should be considered as either the primary or supplemental domestic potable water heating source.
 - c. All piping installations must be in accordance with B31.9 and other applicable codes and standards. Pipe welds must be visually inspected by inspectors assigned by FP&C.
 - d. Backflow preventers must be installed in make-up water lines.
 - e. The following requirements are typical for low pressure service for HVAC and domestic water service. Applicable ASME codes will apply for high pressure steam or gas.
2. Valves
 - a. Ball valves should be used for 2 inch and smaller piping systems.
 - b. When valves are insulated, valves shall have valve stem extensions if required to position operating handle without damaging the insulation.
 - c. Gate valves are to be rising stem and chilled water system valves 6 inches or larger are to have gear type operators.
3. Water and Steam Piping
 - a. Refer to Master Specifications for supply, steam, and condensate piping criteria.
 - b. Copper pipe shall not be used underground or in concrete,
 - c. All solder and brazing materials must be lead free.
 - d. Victaulic ring groove connections can be used for above ground copper pipe connections 2 ½ inch and larger.
 - e. Dielectric unions must be used at all iron to copper pipe connections.
 - f. Water hammer arresters are to be Watts or approved equal by FP&C.
 - g. Automatic air vents are to be installed in all water lines at the high point of the distribution system on each floor and at the high point service connections at air handlers and other equipment.
 - h. Automatic air vents shall have ¾ inch IPS inlet connection and 3/8 inch outlet connection. Each air vent must have a 3/8 inch Type L copper tube discharge line routed from the air vent to the nearest floor drain. A ¾ inch threaded ball valve shall be installed at the inlet to the automatic air vent to permit air vent maintenance.

- i. All riser and branch lines shall have isolation valves to permit equipment and equipment isolation valve maintenance without having to drain the water distribution system upstream of the maintenance point. Isolation valves shall be located at each floor riser, at the intersection between wings of floors, and at point of entry to rest rooms. Appropriate signage shall be posted.
- j. Drain connections with threaded ball valves shall be installed downstream of each isolation valve at the low point in the line to permit draining of water lines. 2 inch and larger lines shall have a minimum $\frac{3}{4}$ inch drain connection and valve. Smaller lines shall have a $\frac{1}{2}$ inch drain connection and valve. A threaded pipe plug shall be installed in the outlet of each drain valve.
- k. Keyed hose bibs shall be provided on 100ft maximum centers around the outside of the building.
- l. In tunnel installations, pipe hangers and shock absorbers shall be added to pipe runs.
- m. At every floor penetration a cast in sleeve or other monolithic curbing at least 2 inches high must be provided to help contain water spills or leaks.
- n. Branch connections from pipe headers must be from the top of the pipe header.
- o. Design operating temperatures and pressures are to be shown on construction drawings.
- p. Metal braided flexible pipe connections are required for pump suction and discharge connections 2 inches and larger.
- q. Pipe supports to be installed as required to prevent pipe loads being supported at equipment connections.
- r. Leak testing of piping systems must be at 1 $\frac{1}{2}$ times system design working pressure and leak testing witnessed by staff assigned by FP&C. Leak testing to be done and accepted prior to insulation of pipe.
- s. Piping should not be installed under concrete slabs without prior approval by FP&C.
- t. Piping system branch connections must use weld or threaded fittings. This requirement applies to instrument connections also.
- u. Thermometer wells and thermometers are required for all air handler supply and return lines 1 $\frac{1}{2}$ inch and larger. Pete's plugs are to be installed in all air handler supply and return water lines.
- v. The Main Campus Central Plant steam supply pressure to the tunnel distribution system has a design maximum of 125 psig, but 75 psig steam pressure is typical for normal operations.
- w. Condensate return pressure at the Central Plant is 30 psig. Provide pumped condensate return to the tunnel condensate return system.
- x. Confirm water metering need with FP&C Project Manager. Electric meters are the top priority for project inclusion, followed by water, chilled water, and steam meters. Auxiliary buildings will be the highest priority for meter location, followed by science and research buildings, followed by E&G buildings 40,000 SF and larger. Water meter basis of design is ONICON Model F-1200 Dual Turbine Flow Meter (and BTU management system) featuring patented non-magnetic impedance sensing method, low-mass non-metallic turbines with sapphire jewel

bearings and tungsten carbide shafts providing an extremely long-wearing mechanical system.

- y. Confirm steam metering need with FP&C Project Manager. Electric meters are the top priority for project inclusion, followed by water, chilled water, and steam meters. Auxiliary buildings will be the highest priority for meter location, followed by science and research buildings, followed by E&G buildings 40,000 SF and larger. Steam meter basis of design is the Onicon F-2500 Series Vortex Flow Meter. Operating as a loop powered device, each F-2500 meter provides a 4 - 20 mA output signal for flow rate and a scalable pulse output. Built-in display provides flow rate and total data, instantaneous temperature, operating status and diagnostic data.
 - z. All steam and condensate piping 2 inch and larger shall be welded with flanged connections.
 - aa. Steam piping is to be sloped downward in direction of flow with drip legs and steam traps installed to keep condensate from collecting in the piping when steam is flowing.
 - bb. Condensate return piping is to be sloped downward in direction of flow.
 - cc. Install strainers with blowdown connections in steam lines upstream of control valves and steam traps. Blowdown valve and line shall be ½ inch for lines smaller than 2 inch and ¾ inch for 2 inch and larger.
 - dd. Upstream and downstream isolation valves shall be installed for each strainer and control valve or strainer and steam trap installation.
 - ee. Provisions for venting and draining steam and condensate lines are required.
4. Gas Piping
- a. All gas piping 2 inch and larger shall be welded. Screwed fittings are permitted for above ground piping smaller than 2 inch except that screwed piping may not be used in chases. Provide a schedule 10 black iron pipe sleeve to completely enclose the gas pipe throughout all chases and concealed areas of the building. The sleeve shall be vented to atmosphere at the top of the building.
 - c. Gas stop valves must be provided for each piece of equipment. Valves 2 inch and smaller shall be lubricated ported plug valves (Mueller or approved equal) AGA or UL approved. Valves 2 ½ inch and larger must be certified for natural gas service.
 - d. All gas piping must be pressure tested for 24 hours and the test witnessed and accepted by staff assigned by FP&C.

D2030 SANITARY WASTE

- 1. Provide floor drains near sinks and in each restroom with floor sloped to drain openings.
- 2. Floor drains are also required in all mechanical rooms, fire pump rooms, laundry rooms and plumbing chase areas and must be accessible with floor sloping to drains.

3. All floor drains will have trap primers or for infrequently used drains, drainage alternatives such as Trap Guard.

D2040 RAIN WATER DRAINAGE

1. Roof overflow drains are discouraged. Roof overflow scuppers are preferred. Refer to Section B3010.9.
2. Insulate all storm drains that run through conditioned spaces. Insulation may be discontinued after one floor.
3. Roof drains shall be run separately from all other storm water sources to outside of the building.

D30 HEATING, VENTILATING, AND AIR CONDITIONING (HVAC)

D3000 GENERAL

1. Exhaust stacks for such equipment as laboratory hoods shall be designed to emit at the highest point away from the new structure, and in particular away from fresh air intakes. Additionally, care shall be taken to consider patterns of air flow and emissions as they relate to the surrounding buildings.
2. In phased projects, motors, fans, coils, pumps, and filters installed in later phases shall match the manufacturer, style, rough-in, and mounting of similar components installed in the first phase.

D3005 MECHANICAL EQUIPMENT ROOMS

1. Mechanical Rooms shall be sized to allow for equipment maintenance and replacement.
2. Stack mechanical rooms vertically in the building.
3. Access to equipment rooms shall be direct from hallways. Do not provide entrance through other rooms.
4. Walls of equipment rooms, when located on occupied floors shall be sound proofed and return air passages shall utilize sound attenuation boxes.
5. Provide a 4" high curb around duct, pipe, conduit, etc. penetrations through the floor when occupied space is on the floor below. All penetrations shall be sealed with fire proof material.
6. Depress floor 1-1/2"± at walls and uniformly slope entire floor to floor drain(s) 1/16" per foot.

7. Provide lifting eyes in mechanical rooms as required for heavy equipment maintenance.
8. Provide housekeeping pads for equipment.
9. Ventilate under floor areas.
10. Freight elevator access from mechanical rooms is required to move heavy equipment between ground floors and other floors.

D3010 ENERGY SUPPLY

1. Buildings constructed within the campus core will be connected to the existing campus utility tunnel as determined by UH Utility Services and will receive chilled water and steam from the Central Plant.
2. Chilled water is supplied to building at 45 deg F.
3. Steam is supplied at 75 psig saturated.
4. Condensate return units are required to pump building condensate back to the Central Plant. The utility tunnel condensate return header pressure is about 80 psig.
5. Buildings having their own AC compressor units will be designed for 45 deg F chilled water supply temperature if eventual tie in to the Central Plant is planned.

The TDLR Texas Boiler Law issued changes effective June 15, 2015. Where the new requirements conflict with this narrative the new requirements shall take precedence.

7. Natural gas fired boilers installed on the UH campus that are rated at 2MM BTU maximum heat input and less; must comply with the requirements of 30 TAC 117 475 (controlling NOx emissions at a minor source in Harris County). Acceptable emission levels vary with the hp rating.
8. Any new steam boiler shall be the hi-efficiency, lo-NOx type (7 ppm max during startup testing), complete with flue gas heat recovery.
9. For boilers greater than 2 MM BTU pre-approval is required by the Environmental Health & Safety Department. These boilers must be equipped with NOx emission control devices. NOx control is defined as flue gas emissions not to exceed 30 ppm by volume at 3% oxygen, dry basis. Additional requirements include a fuel feed meter and boiler combustion shall be controlled with oxygen, CO or fuel trim.

D3040 AIR HANDLERS AND DUCTWORK

1. Built up air handlers shall have an air tight sectionalized casing construction of lock forming quality galvanized steel. Outer section to be 20 gauge sheet and 22 gauge inner sheet minimum with 2 inch 3 pound density insulation in between perforated metal wall. Non-perforated inside duct wall is required in chilled water coil duct section as described below. Galvanized metal shall not be painted; phosphatized or bonderized metal shall be finished with rust inhibiting paint. For maximum rigidity casing shall be properly reinforced and braced with steel angle framework with the same finish as casing. Casing shall consist of a fan section, a coil section or sections, and a continuously draining stainless steel drain pan. Suitable gaskets shall be provided at all joints between casing sections. Stiffeners shall be provided as required to prevent unit casing pulsations. The double wall non-perforated metal casing must extend downstream past the cooling coil at least three feet. Thermal break insulation is to be installed as required to prevent sweating on exterior surface of air handler casing.
2. The coil section of built up air handlers shall completely enclose all connections, coil headers, and return bends. Air seals for coil piping penetrations are to be installed.
3. Coil frames for built up air handlers shall be used as structural members of the coil section. The coil section shall be constructed in such a manner that the coils be removed without affecting the structural integrity of the casing. Coil frames shall be constructed of 304 stainless steel and shall have intermediate stiffeners if over 5 ft long.
4. Air handler coil condensate collecting drain pans shall extend under the complete coil section (at least 18 inches beyond coil) including access and plenum sections between multiple coils, and shall be rigid, watertight and sloped to drain continuously to prevent condensate build up in drain pan. The drain pan to have slope to ensure continuous condensate drainage with threaded pipe connections at low point of drain pan. Drain pan shall be of the double wall insulated type with a 304 stainless steel inner pan and a galvanized or stainless outer pan with tell-tale drain exposed. Pan insulation shall be 1 inch thick high density fiberglass closed cell cemented and vapor sealed between the inner and outer pan or ½ inch thick foamed in place closed cell insulation.
5. Built up air handler access doors, at least three-quarter of a square foot but no larger than six square feet in size, shall be furnished in the fan and coil sections to provide access to internal parts for maintenance. Doors whose smallest dimension is 12 inches or less shall be equipped with Amertoc 10 or Ventiok Style 100 latch, all other doors shall be equipped with Ventiok Style 140 latch and Ventiok Style 150 hinges (or equal manufactured by Amertoc and approved by FP&C). Doors shall be located so that the unit may be inspected or entered regardless of installation arrangement. Door installation shall be separate form unit insulation and shall be secured and sealed as specified for unit casing insulation. Access doors shall be located on the most accessible side of the air handling unit as it is installed.

6. If a chilled water rooftop unit (RTU) must supply air around the clock, it must have provisions to prevent coil freezing, including preheat capability for the designated volume of air thru the RTU.
7. Centrifugal fans shall be double width, double inlet, multi-blade type. Fans shall be fabricated of galvanized steel, all aluminum, or fabricated steel protected with two coats of rust inhibiting paint. The air handling unit fan rpm shall not exceed 600 rpm unless exceptions are approved by FP&C.
8. Fan shafts shall be of one piece solid construction. Diameter of shaft between stubs must not be reduced and stub shaft diameter to be the same at both ends.
9. Fan shafts shall have SKF, Sealmaster, Timken or Fafnir externally mounted grease lubricated self aligning ball bearings. Bearings shall be heavy duty and have an average service life of 200,000 hours. Life lubricated sealed bearings are not acceptable. Shafts with internally mounted bearings shall have grease lines extended with metallic tubing and shall be accessible from the drive side of the unit. In addition, the bearing on the drive side of the unit shall have grease line extended beyond the belt guard. All grease lines shall terminate in a zerk fitting.
10. Air handler coil tube shall not have more than 10 fins per inch or more than six rows of tubes per coil. Air handler coils must have accessible vents and drains.
11. Air handler coils must be tested at 1 ½ times design working pressure.
12. Air handler coils must have accessible vents and drains.
13. Air handler coils must be tested at 1 ½ times design working pressure.
14. Hot water heating coils may be installed in mechanical rooms only. Electric heaters must be used in other locations.
15. Chilled water coil face velocities shall not exceed 500 feet per minute.
16. Coil tube water velocities shall not exceed 6 feet per second or go below 2 feet per second.
17. Maximum allowable coil height is 54 inches.
18. Provide belt guards for all fan drives mounted outside the unit casing. Guards shall conform to the contour of the drive assembly. Material, construction, and finish of the guards shall be similar to that of the unit casing. Guards shall be braced and fastened so that objectionable vibration will not occur. Provide tachometer openings at least 2 inches in diameter for checking fan and motor speeds. The tachometer openings must be in line with shaft axis. Two section fan guards shall be

designed in such a manner that either section can be removed without removing the adjacent section.

19. Air handler fan motors shall be mounted on the coil connection side. Motors are not to be mounted on top of the air handler. Motors shall be factory mounted on an adjustable base rigidly connected to the-vibration isolated frame.
20. Air handler filter holding frames shall be fabricated of 16 gauge galvanized steel equipped with tight fitting gaskets and suitable fasteners to accommodate 2 inch ASHRAE 35 percent-air filters. The fasteners shall be capable of being attached or removed without the use of tools.
21. Pre-filtering and filtering required for outdoor supply air handlers: Typically 4 inch 65 percent pleated filters for air handler filters on outside air units.
22. Contractor is not to operate air handlers without filters installed. Contractor to provide filters for use during construction phase of project and one complete set of filters to be installed by contractor at end of construction phase of the project. If Contractor operates air handlers without filters or properly installed filters, **the** contractor will be required to do the necessary cleaning at no charge to the University.
23. Air handling equipment and ductwork must be kept protected during storage and the construction phase of the project to prevent water, dirt and trash getting into the inside of the air handling equipment and ductwork. If FP&C/FM inspection staff determines that equipment or ductwork is not clean, the contractor will be required to do the necessary cleaning at no charge to the University.
24. Air handler installation must permit access for maintenance such as filter changing, coil and blower removal.
25. A secondary containment condensate collecting pan is required to catch condensate drain pan accidental overflow for all fan coil units installed at or above the ceiling. A tell-tale drain from the secondary drain pan is required to divert overflow to an area where the overflow can be seen without causing water damage to equipment or furnishings.
26. Ductwork shall be externally insulated. The use of angle iron to support insulated ductwork is recommended because it is easier to insulate the assembly.

Where unistrut is used at insulated ducts, the flat face of the unistrut channel typically shall be installed against the duct. Insulation blocking shall be required at the unistrut so that the rigid insulation is around the duct, the blocking is between the duct and the hanger, and the unistrut does not become part of the vapor seal.

In the case of the open side of the unistrut channel facing the duct, the open side of the unistrut shall be packed with insulation so that there is not an air void that can allow condensate migration. The wrap installed around the hanger and the vapor mastic shall be complete around the installation.

27. Leak testing of ductwork (ductwork downstream of terminal boxes, returns, exhaust, and outside air duct will visually inspected) is repaired. Maximum allowable leakage is 5 percent of design flow. Air and Water Balancing Contractor will conduct the leak testing of the ductwork for the University's acceptance. Test method to be in accordance with SMACNA "HVAC Duct Construction Standards".
28. Multiple blade air flow control dampers shall be opposed blade, low leakage type with sealed ball bearings for damper blade shafts.
29. Multiple blade air flow control dampers shall be opposed blade, low leakage type with sealed ball bearings for damper blade shafts. All damper actuators to be mounted outside ducts.
30. Weather-proof lights with externally mounted switches shall be installed between coil sections and in blower section.
31. All air handler motors shall have variable speed drives.
32. Fan coil units located in exit stairwells shall be interlocked with additional fire alarm devices that discontinue FCU operation when the fire alarm system is activated. The FCU may only serve the area in which it is located.

D3045 CENTRIFUGAL PUMPS

1. Centrifugal pumps shall be horizontal split case type.

D3060 BUILDING TEMPERATURE CONTROL SYSTEM

1. The selection of the building controls will be by UH Utility Services (EMECS) department. The temperature control system for the new building projects or large renovation projects shall be fully open native Bacnet system. BACnet building automation system specifications can be found at: http://www.uh.edu/plantops/departments/fpc/master-specs/23%2006%2006UH%20BACnet_Spec11.pdf.
 - b. General: The control system shall consist of a high-speed, peer-to-peer network of DDC controllers and a web-based operator interface. Depict each mechanical system and building floor plan by a point-and-click graphics.
 - c. An Uninterrupted Power Supply (UPS) is required on all control panels, not just primary.

- d. An open license JACE 600 or higher shall be installed on separate IP address and tied into the buildings' BAS system.
 - e. If individual software seat licenses or keys are required provide a minimum of 10 additional licenses to accommodate multiple owner operators.
 - f. The system shall directly control HVAC equipment as specified in Sequences of Operation. Each zone controller shall provide occupied and unoccupied modes of operation by individual zone.
 - g. Furnish energy conservation features such as optimal start and stop, night setback, request-based logic, and demand level adjustment of setpoints.
 - h. System shall use the BACnet protocol for communication. Schedules, setpoints, trends, and alarms specified in Sequences of Operation shall be BACnet objects.
 - i. All network addresses, device addresses, and point names must be visible and controllable (by UH Utility Service EMECS group) from the provided programming tool.
 - j. The Bacnet "stack" must reside on each Bacnet controller (physically on the device and not on the Master sharing proprietary devices).
 - k. All devices must bear the BTL certification stamp and with details such as UH Building #, Equipment controlled, location etc.)
 - l. Coordinate with UH Plant Operations Utility Services (EMECS) group for the type of control system to be specified for small renovation projects in the existing buildings with Honeywell or JCI control systems.
- 2. Pneumatic actuators and controls are not to be used unless prior approval has been obtained from UH Utility Services Department.
 - 3. Fire detection and alarm functions and security system functions are not to be part of the EMECS. Separate fire and security systems are required.
 - 4. Installation:
 - a. Provide a securable 16" deep x 3' wide x 8' tall securable closet in every new building in the Main Mechanical Room where the Master BAS Controller/Phoenix Server will be housed and the air conditioning, IP ports, and electrical will be provided.
 - b. Control valves must not be installed upside down
 - c. All exposed control wiring in mechanical rooms or inaccessible locations to be in EMT conduit.
 - d. Do not install control panels under water lines or next to water lines and equipment that could damage control panel in event of water leak. Do not make conduit penetrations in top of panel.

- e. Each control panel must have at least 20 percent spare capacity. Spare capacity can be achieved with the addition of I/O modules at a later date. Conduit shall have 10 percent spare capacity if conduit length is over 100 feet.
- f. All low-voltage control wiring which is routed through concealed accessible locations may be run without conduit provided that the wiring run without conduit is properly supported from the building structure on maximum 5 ft centers, secured with plastic tie-wraps, smoke rated for plenum installation and not dependant upon the ceiling grid for support. Control wiring is to be run at right angles to or in parallel with axis of rooms and not diagonally across ceilings, etc.
- g. Control wiring shall not be installed in the same conduit with power wiring.
- h. Control wiring for service up to and including 24 volts shall be rated for at least 300 volts.
- i. All temperature sensors shall be calibrated by controls contractor at startup and calibration data sheets showing offsets submitted to Utility Services (EMECS).
- j. All air handler chilled water control valves shall be two-way valves. All wiring to be green with white stripe and with text saying Bacnet EMECS wiring.
- k. Chilled water and hot water valve control to be separate controller outputs; tandem control from a single control output is not to be used.
- l. Actuated valves on the building chilled water supply and return shall be provided to allow for emergency, maintenance, or replacement isolation of the building piping system from the distribution loop. The valves shall be located just inside the building in an easily accessible location. Where specified for isolation, actuated valves shall be provided on the tertiary chilled water supply and return piping.
- m. New control panel locations and reuse of existing locations for new installations must be approved by Utility Services (EMECS).
- n. All exposed old and unused EMECS components, wiring and conduit to be removed by controls contractor.
- o. Locations of temperature and humidity sensors must be approved.
- p. Single spaces served by more than one VAV, fan coil unit or air handler are to be controlled by input from a single temperature sensor with single set point. Exceptions for multipurpose spaces must be approved by Utility Services (EMECS).
- q. Control of outside air dampers shall be from dedicated analog or digital outputs as required by the sequence of operation.
- r. All single zone air handling units shall have a discharge air temperature sensor mounted in the supply air at discharge from the chilled water and hot water coils.
- s. Steam flow to hot water converters shall be controlled by one third capacity valve and two thirds capacity valve. Each valve shall have a separate control loop.

- t. All field wiring shall be labeled both in control panels and at device. Use text descriptive labels, not just numeric identification; for example AHU1CLVLV.
 - u. Terminal strip required for all connections in control panels.
5. Service Requirements – General
- a. All variable speed motor drives must restart automatically after loss of power.
 - b. Air handler chilled water and hot water valves to shut off automatically when air handler is stopped.
 - c. Air handler chilled water valves are to fail in the as-is position.
 - d. Simultaneous air cooling and heating is not permitted, except reheat for humidity control, and one valve must be closed before the other can open. Both valves will be controlled by discharge air temperature.
 - e. Status indication for valves and other control elements to be 0 for closed and 100 for open.
 - f. Graphics must be schematically correct and represent the actual physical configuration of air handlers, pump systems, floor plans, etc. Room locations for all equipment, including sensors, must be shown and the room numbers for spaces served by electric duct heaters, VAV boxes, etc. must be shown on air distribution mechanical plans.
 - g. Automatic controlled valves shall be furnished by controls contractor unless otherwise indicated in the bid documents. Automatically controlled dampers, except dampers integral to the air handling units, shall be furnished by Controls contractor .
 - h. VAV box dampers, fan relays, electric duct heater relays, and 24 volt control power supply transformers shall be provided by the terminal unit manufacturer. Building controls contractor will furnish the Application Specific Control Unit (ASCU), temperature sensor, and damper actuator. The ASCU will be shipped to the VAV terminal manufacturer to be mounted on the unit. Controls contractor will provide all necessary labor and miscellaneous cost associated with set up and testing of the controllers prior to shipment. A typical controller shall be tested for inclusion of all necessary features and control system compatibility. UH Utility Services (EMECS) may elect to have all units tested and witnessed by assigned staff.
 - i. All 120 volt power to pump room, central fan system, and terminal unit DDC controllers shall be by the Division 16 contractor. All 120 volt and 24 volt power to combination fire/smoke dampers and smoke dampers shall be by the Division 16 contractor.
 - j. Controls contractor will submit for approval complete brochures and schematics for entire control system, including performance curves showing leakage rate for dampers, and data indicating trim, pressure ratings and close off pressure for valves. Controls contractor will submit for approval schematic diagram drawing which show all temperature control, equipment interlocks, and all connection information required for properly controlling the mechanical equipment. Controls contractor will provide for approval a complete points schedule and schedule showing each item of mechanical equipment and the

start-stop arrangement of each. Each schematic shall have an accompanying verbal explanation of the control functions.

- k. Controls contractor will provide as built drawings on AutoCAD edition specified by FP&C of all control installation drawings and submittals. Drawings shall show panel locations, 24 volt DC sources, zone controller locations, communication wire path, and electric reheat panel locations.
- l. EMECS readout for air handler discharge air temperature (each zone) is required for all air handlers, fan coil units, and double duct mixing boxes.
- m. All controllers have portable operator's terminal jack for programming and troubleshooting.
- n. Conduit and wire between the fire alarm systems and the Fire/Smoke Dampers and Smoke Dampers to isolate smoke zone in the event of a fire shall be by the Division 16 contractor. Conduit and wire between the fire system control relay and HVAC fan motor starters to de-energize the fan in the event of a fire shall be by the Division 16 contractor.
- o. Terminal strip required for all connections in control panels. Dampers shall have manual and automatic control from 0-100% from building automation control interface.
- p. Electric duct heaters with more than one element or strip shall be staged to control operation as heating load varies.

6. Standard Control Sequence - VAV Air Handling Unit Type A

- a. The supply of air fan shall be provided with a hand-off-auto (HOA) switch at the motor variable speed drive. When the HOA switch is in the auto position, the supply fan shall be started and stopped through the EMECS. When the HOA is in the hand position, the supply air fan shall be manually started and stopped. The air flow status of the fan shall be indicated at the EMECS through a differential pressure air flow switch.

7. Standard Control Sequence - Multizone Air Handling Unit Type

- a. The supply air fan shall be provided with an HOA switch at the motor drive or starter. When the HOA switch is in the auto position, the supply air fan shall be started and stopped through the EMECS. When the HOA switch is in the hand position, the supply air fan shall be manually started. Status of the supply air fan shall be indicated at the EMECS through a differential pressure air flow switch.
- b. The outside air damper shall open fully whenever the supply air fan is energized or a start signal is issued from the EMECS. It shall be fully closed when the supply air fan is de-energized.
- c. A temperature sensor (THIS SENSOR MUST BE ON ALL AIR HANDLERS REGARDLESS OF CW VALVE CONTROL INPUT), sensing the air leaving the chilled water coil, shall provide an input to the DDC panel which shall, through a proportional plus integral DDC control algorithm, output a signal to modulate the normally open chilled water control valve to maintain 55 degree F discharge

- air temperature. The control valve shall close when the air handling unit is stopped.
- d. Space temperature shall be input into the DDC panel for each zone. The DDC panel shall output a signal to modulate the zone damper and reheat valve (or electric duct heater) in sequence to maintain space temperature set point. The control shall incorporate adequate dead band to prevent simultaneous heating and cooling of air except for humidity control. The heating system will shut off when the air handler is stopped.
 - e. Each zone shall have separate discharge temperature sensors and independent control for each zone damper and heating valve or electric heat.
 - f. Constant speed air handlers must be provided with variable speed driver for soft start and air flow adjustment.
8. Standard Control Sequence - Preheat Coil
- a. A wall mounted temperature sensor shall input to the DDC panel which will output a signal to modulate the cooling and hot water coil valve in sequence (no over lap of opening) to maintain space temperature. Status of the supply fan shall be indicated at the EMECS through a differential air flow switch. Air handler discharge air temperature shall be indicated at the EMECS through a discharge temperature sensor. Unit shall operate on 100 percent return air unless specifically noted on design drawings.
9. Standard Control Sequence-Preheat Coil
- a. A temperature sensor sensing the air leaving the preheat coil shall provide an input to the DDC panel which shall, through a DDC control algorithm, output a signal to modulate the preheat coil hot water control valve (or electric heating coil) to maintain a minimum leaving temperature of 55 deg F. If the air temperature leaving the preheat coil falls below 35 deg F, a manual reset low temperature thermostat shall full open the chilled and hot water valves, de-energize the supply fan, and produce an EMECS alarm.
10. Standard Control Sequence-Single Duct VAV Terminal Units
- a. The single duct VAV terminal units shall consist of a volume damper, an air flow pickup, a microcontroller, damper actuator, and a space temperature sensor.
 - b. The microcontroller and damper actuator shall be provided by Controls contractor to the terminal unit manufacturer for factory installation and calibration. Controls contractor shall furnish and install communication bus to the microcontroller and low voltage wiring between the space temperature sensor and the microcontroller.
 - c. The primary air volume damper and the reheat valve (or electric duct heat stages) shall be modulated in sequence by the DDC microcontroller in order to maintain the space temperature as sensed by the electronic temperature sensor. The microcontroller shall, through its air flow pickup in the primary air supply duct, provide for pressure independent volume control.
11. Standard Control Sequence – Fan Powered Induction Boxes

- a. The fan powered induction box shall consist of a fan, electric duct heater, if scheduled, a volume damper actuator, and a space temperature sensor.
 - b. The microcontroller and damper actuator shall be provided by controls manufacturer to the terminal unit manufacturer for factory installation and calibration. Controls manufacturer shall furnish and install communications bus to the microcontroller and low voltage wiring between the space temperature sensor and the microcontroller.
 - c. On a call for full cooling, a wall mounted temperature sensor shall modulate the cold air valve fully open. The pressure independent microprocessor control network shall cause the supply air quantity to not exceed the scheduled amount and automatically maintain desired air flow with up stream fluctuations of up to two inches water gauge.
 - d. On a call for less cooling, as sensed by the room temperature sensor, the cold air valve shall modulate from fully open to the scheduled minimum air quantity.
 - e. On a call for heat, with the supply air at scheduled minimum quantity, the electric duct heater stages shall schedule as needed to maintain space temperature.
 - f. The VAV unit supply fan shall be interlocked through software to run anytime the air handling unit fan is on and automatically stop when the air handling unit fan is off.
12. Warranty period will commence upon completion of all point acceptance testing for EMECS work performance and acceptance by UH Utility Services Department.
13. All PID control loops shall be tuned by controls manufacturer to ensure stable (no hunting). Tuning to be verified by Utility Services (EMECS).
14. Only alarm points specified by Utility Services (EMECS) shall be displayed to operators terminals.
15. Control System Element Specifications:

Water Valve Actuators

Averaging temperature sensor - All AHUs shall have averaging temperature sensors with a probe length of 12 feet minimum or one linear foot per square foot of duct cross-sectional area, whichever is greater.

Single point duct mounted temperature sensor shall be stainless steel probe of 12 inch length with duct mounted moisture/waterproof housing with conduit fitting.

Temperature sensor thermowell shall be rigid stainless steel probe of length which is, at minimum, 20% of pipe width with stainless steel thermowell. Provide with thermal grease to aid temperature sensing.

Freezestat shall be a minimum 20 feet vapor tension element which shall serpentine the inlet face on all coils or one linear foot per square foot of coil surface area.

Duct mounted static pressure sensor shall have an input range of 0 to 500 Pa (2.0 inches w. g.) and be easily accessible, integral non-interacting zero and span

adjustment.

Space static pressure sensor shall have an input range of -0.1 to +0.1 inches w.g., and be easily accessible, integral non-interacting zero and span adjustment.

Duct mounted air flowrate sensor shall be multipoint flow cross or grid measuring device with bulkhead fittings to allow sensor tubing to be connected or removed without removing ductwork. Sensing grid shall be constructed of 304 stainless steel.

Fan inlet air flowrate sensor shall be multipoint flow cross or grid measuring device mounted at the inlet of the fan. Bulkhead fittings to allow sensor tubing to be connected or removed without removing the device from the fan shall be provided.

Differential pressure for liquid flow shall be a microprocessor based transmitter which measures differential pressures and transmits an output signal proportional to the measured variable. Manufacture: Rosemount 1151 Smart Pressure Transmitter with equalizing manifold.

D3070 AIR AND WATER BALANCING

1. FP&C will provide air and water balancing services under separate contractor.
2. Contract will be required to support access to equipment for air and water balancing contractor. For example, the contractor may need to provide ladders or a lift for equipment access.

D40 FIRE PROTECTION

D4000 GENERAL (see also Section 12.0d-- ADDENDUM D: Alarm and Special Hazard Protection Specifications)

1. The University of Houston Fire marshal's office is the Authority Having Jurisdiction ("AHJ") for the University of Houston System.
2. All University of Houston fire alarm devices, components and controls will be SimplexGrinnell. No other manufacturers' fire alarm devices, components or controls are allowed without written approval from the Associate Vice Chancellor/Vice President of Plant Operations and the University of Houston Fire Marshal's office.
3. All fire suppression controls must be compatible (interface and full communication capable) with SimplexGrinnell's controls and network system.
4. All fire and life safety system plans must be reviewed, approved, and stamped by the University of Houston Fire Marshal's Office prior to installation.

5. Acceptance tests must be conducted for all fire and life safety systems prior to occupancy. The University of Houston Fire Marshal's Office must conduct and/or witness all such testing

D4010 SPRINKLERS

1. All University of Houston buildings will be sprinklered.
2. The design consultant shall include in the bid documents the fire protection sprinkler system – sprinkler head and main header location plans, riser locations and diagram. Risers shall include sprinkler header take-offs with fire alarm points located.
3. Drawings shall be laid out to allow for the addition, at the completion of construction, all as-built header and branch piping to each sprinkler head.
4. The fire protection sprinkler system and standpipe system shall be designed by a registered professional engineer or an organization which possesses a valid certificate of registration as issued by the state fire marshal and has at least one (1) person engaged in or working on the actual plans, who is licensed to perform the work authorized by his certificate.
5. The fire protection systems shall be designed in accordance with the requirements of National Fire Codes and these guidelines except that electrical rooms housing switch gear, transformers, and emergency generators will not be sprinklered nor have any pipes routed through their space. All materials shall be approved by Underwriters Laboratories and/or Factory Mutual Laboratories. Compliance with Article 5.43-1 and 5.43-3, Texas Insurance Code is required.
6. Sprinkler piping shall be Schedule 40 A.S.T.M A53 steel pipe. No flexible sprinkler head drops will be allowed. Only hard-piped offset and drops will be permitted.
7. Sprinkler piping on each floor shall have isolation valves with tamper switches at riser connections.
8. Smoke detectors are also required in buildings with sprinkler systems.
9. At connections to fire service main, fire protection systems shall include a post indicator valve installed outside the building in accordance with NFPA 13 and a building-interior sprinkler control valve with indicator in the sprinkler riser room.

D4030 FIRE PROTECTION SPECIALTIES

1. The number, size and type of portable fire extinguishers shall be in accordance with the requirement of NFPA-10 and as determined by FP&C. Compliance with Article 5.43-1, Texas Insurance Code is required.
2. Fire fighting equipment, such as hoses and extinguishers, shall be approved by the UH Department of Public Safety Fire Marshal office.
3. University of Houston fire protection consultant will review the design consultant's plans and make recommendations to incorporate in the bidding documents.

D50 ELECTRICAL

D5000 GENERAL

1. Electrical and telecommunications rooms will stack vertically through the building.
2. Provide 2 hour rated walls for all electrical and telecommunications rooms.
3. Electrical and telecommunications rooms will be open above the ceiling and have a minimum of three open walls for distribution.
4. Electrical wall outlets which include a USB port for charging electronic devices may be considered for student lounges, classrooms, informal learning spaces, and similar spaces.
5. In all new facilities/major electrical renovations, a confirming Short-Circuit study shall be performed in order that all new circuit breakers, panelboards, fuses and other protective devices are properly rated for the maximum imposed system fault current. A Protective Device Coordination study shall also be performed to provide device settings for adjustable circuit breaker trip devices.
6. Projects of lesser scope which add to or change the existing balance of the existing electrical infrastructure shall also be considered for these two studies. Confirm with Plant Operations FM Utility Group.
7. A 208 Volt single phase 2 pole 30 amp twist lock receptacle shall be added to the roof for the proper operation of a swing stage

D5010 CAMPUS ELECTRICAL SERVICE AND DISTRIBUTION

1. Electrical service for the campus is furnished by CenterPoint to the University of Houston Cougar Substation at 138 KV. From Cougar Substation, 12.47 KV power is supplied by three feeders to the Central Plant, two feeders to Health & Bio Med Plant, and two feeders to the ERP Campus. Then to campus buildings through the utility tunnel and underground duct banks from the switchgear in all three locations. Most all of the main campus buildings is served by two 12.47 KV feeders with an

automatic transfer switch to supply electrical power to a building in case there is a loss of power from the primary feeder. Some buildings are served directly from CenterPoint street utilities. Each building has a transformer to reduce the 12.47 KV distribution voltage to the required building service voltage. New building service voltage shall be 277/480 volts, 3 phase, 4-wire wye.

3. Dry or oil filled “preferred” type transformers shall be used for building electrical service to provide 480 volt to volt, 3-phase, 4-wire, wye distribution.
4. The building 12.47 KV transfer switches shall be 3-position (preferred feeder, off, standby feeder) **utilizing load side vacuum interrupters** which will be coordinated with system vacuum breakers. Transfer switches are to be SF6 type. All 15KV ATS shall have closed transition switching capability on the line side.
5. Building distribution switchgear shall have equal to or great capability of a Square D Class CM4000 power logic circuit monitor(s) with AO420 attachment or (alternate approved by Facility Authority). The following parts are necessary: LED Display, JOX I/O extender module, CAB12 Serial cable, Current Transformers either clamp-on or molded, fuse holders and fuses on voltage circuit, shorting block for CT circuit. The power monitor shall have a digital display capable of monitoring all primary power parameters including total harmonic distortion, transient voltage, trending, and wave form capture on voltage and amperage. All metering must have Ethernet and MODBUS capability.
6. Confirm smart electric metering need with FP&C Project Manager: Electrical energy savings have the greatest benefit to the campus utility budget, therefore electric meters will be the top priority for project inclusion, followed by water, chilled water, and steam meters. Auxiliary buildings will be the highest priority for meter location, followed by science and research buildings, followed by E&G buildings 40,000 SF and larger. Smart electric bases of design are:
 - i) E-Mon Class 5000 Smart Meter w/Dual Protocol Communications featuring 4-line display (kWH, KWH/Demand with peak time and date, power factor per Phase, kW real-time load, and amps and volts per phase). On Board Set Up Options shall include IP Address, meter date/time ID codes for E27 and BACnet.
 - ii) E-Mon Green Class Meter with CO₂ and Carbon Footprint Data featuring direct-read two-line LCD display showing kWH, current load, peak Demand in kW and peak date and time; to-date energy cost based on user-entered cost per kWH and projected hourly cost based on metered load; and display of total carbon (CO₂) emissions in pounds (lbs.) and hourly emissions based on metered load.
7. Electrical smart-meters shall be located in the building electrical rooms.
8. Underground 480V (and greater) KV electrical power cables to be in 4 inch PVC conduit encased in red concrete. The top of the concrete duct bank shall be a

minimum of 36 inches below grade. A number 4 rebar shall be installed in each corner of the duct bank. PVC conduits shall be supported in duct bank using PVC spacers providing a minimum of 3 inch separation between conduits.

9. Power cable for 12.47 KV electrical power distribution in utility tunnel must be in 4 inch rigid aluminum conduit. Conduit shall be supported vertically with unistrut brackets that extend from the floor to the ceiling or the tunnel. Brackets shall be anchored to the structure at both ends using suitable anchors. Conduits shall not be supported from the wall of the utility tunnel.
10. All 12.47 KV conduit fittings shall be threaded. Where conduit unions are necessary, provide Appleton type EC or Thomas and Betts "Erikson Coupling".
11. Use rigid galvanized steel elbows or rigid aluminum elbows in utility tunnel and building conduit runs. The minimum bending radius of conduit elbows shall be 36 inches.
12. Prior to initial energization of the work and before final review and acceptance of all 12.47 KV feeder construction work, all cable shall have high potential proof tests performed and test results accepted by FP&C. Utility Services shall be present and witness the testing. Contractor shall provide field reports to customer followed by final reports in project close out package.
13. Prior to completion of the work and before final review and acceptance of all 12.47 KV feeder construction work, all cable shall have high potential proof tests performed and test results accepted by FP&C. Utility Services shall be present and witness the testing.
14. The 12.47 KV service at each new building must be tested to insure proper phasing for rotation and to insure the phase sequence for each feeder is the same for the building.
15. All below grade building or utility tunnel conduit wall penetrations must use Thunderline Corporation "Link Seals" to make penetrations leak proof.
16. Manufacturer's specified minimum bend radius for cable shall not be exceeded.
17. When cable is in free air, for temporary only, it shall be anchored at 3 foot intervals with Unistrut Force-A-Clamp insulators P1787A through P1795B or equivalent.

D5015 BUILDING ELECTRICAL EQUIPMENT AND ELECTRICAL DISTRIBUTION

1. Use heavy chrome-plated or nickel-plated escutcheons for conduit passing through walls and ceilings of finished areas. Use B&C Number 10 or alternate approved by FP&C/FM.
2. Whenever access is required through wall or ceilings to concealed junction boxes or other concealed electrical equipment, a hinged access door and frame is required to be installed with door opening location and opening size as required for inspection and maintenance. Access door to be equipped with cam locks.
3. Motors:
 - a. Premium or super efficiency motors with cast iron frame are to be specified (Gould E-Plus, General Electric "Energy Saver", Reliance XE, Century, Balor Super E or UH approved alternate).
 - b. Motors are to be specified with Class F insulation and Class B temperature rating.
4. All wiring terminations shall be labeled in the pull box, distribution panels, and switchgear. All outlet devices connected to emergency power shall be identified by labeling stating that it is an emergency device, or the device itself shall be colored red. A red painted cover is an acceptable substitute for red coloring provided by the device manufacturer.
5. All #6 AWG and larger conductors shall be connected with high conductivity, wrought copper, color-keyed compression connectors. Crimping tools, dies, and connectors to be by same manufacturer, and crimping shall be done by electricians certified for the crimping tools used.
6. Bolted Bus Bars:
 - a. All electrical bus must be copper.
 - b. Bus bars shall be 98 percent conductivity, round edge copper with through bolted connections.
 - c. Bolted bus joints shall be ring silver plated and shall contain a minimum of two bolts per joint. Utilize U.S. manufactured, capacity identified, silicone bronze bolts, nuts, flat washers, and lock washers. The torque wrench settings and the required bolt capacity for splice plate connections, etc. shall be listed on the Shop Drawing for the bus assembly. All torque values to be verified and approved in writing by project licensed electrical engineer. Bolted connections must be accessible for inspection and maintenance.
7. Wiring:
 - a. All wiring must be copper.
 - b. All electrical power wiring must be installed in conduit (EMT, or rigid galvanized steel conduit).
 - c. Use mogul LB conduit fittings.

- d. All wire insulation to be THHN or THWN.
- e. All feeders and branch circuits shall be #12 AWG or larger.
- f. All wire larger than #10 AWG shall be stranded.
- g. Flexible metal conduit is permitted at motor, fixture, and other equipment only.
- h. The contractor shall follow the manufacturer's directions for delivery, storage and handling of equipment and materials.
- i. Equipment, electrical cable, and material shall be tightly covered and protected against dirt, water, chemical, physical or weather damage and theft.

D5020 LIGHTING

- 1. Building interior light shall primarily be T-5 or T-8 Florescent lamps with electronic ballasts.
- 2. LED fixtures shall be considered for elevator lobby, stairwell, high ceiling, and other difficult to access ceiling areas. Lighting designer shall confirm adequacy of light distribution in evaluating suitability of LED usage in these applications. LED lighting will otherwise be considered on a case-by-case basis.
- 3. U-tube lamps shall not be used.
- 4. Classroom and office lamp color temperature shall be between 3,000 and 3,500 degrees Kelvin.
- 5. LimeLite Technologies', Inc. proprietary Light Emitting Capacitor (LEC) DirectVu™ lamp may be used for exit lighting.

D5030 FIRE DETECTION AND ALARM SYSTEM

- 1. All systems must be SimplexGrinnel voice "capable," and communications compatible with the campus fire alarm network.
- 2. The design consultant will meet with the University's designated fire alarm consultants to receive their recommended design factors. The design consultant will incorporate required design factors into the bidding documents. The fire alarm consultant will prepare the required drawings that will be inserted into the bidding documents.
- 3. The fire detection and alarm system shall be designed in accordance with requirements of pertinent sections of the National Fire Codes by a firm registered in the State of Texas and whose employees have a valid fire alarm planning superintendent's license or fire alarm technician's license issued by the state fire marshal. All material shall be approved by Factory Mutual Laboratories and Listed by Underwriters Laboratories. Compliance with article 5.32-2, Texas Insurance Code is required.
- 4. The Control Center shall be located in a secured area inside of a building.
- 5. Four (4) fiber optic cables are required for each building fire alarm system service connection tie-in to the campus fire alarm network.

6. Smoke detectors are also required in buildings with sprinkler systems.
7. Four percent (4%) spare sprinkler parts (or quantity per NFPA-13, whichever is greater) are required.
8. SimplexGrinnell shall provide training for sprinkler system and fire alarm system operation.
9. A mass notification system such as Alertus Beacons is required in certain public spaces. Consultant shall coordinate with the UH Department of Public Safety and FP&C for specific requirements.

D5035 TELECOMMUNICATIONS SYSTEMS AND FACILITIES DESIGN

1. Up to date Telecommunication system and facilities requirements / network cabling standards and recommendations can be found at: <http://www.uh.edu/infotech/services/computing/networks/telecom-infra-standards/index.php>
Or by typing “network infrastructure standards” into the uh.edu search engine.
2. Telecommunication facilities are typically dedicated spaces which are not shared with other building services. Entrance Facilities, Equipment Rooms, Telecommunication Equipment, and Telecommunication Rooms may not be accessed through mechanical or electrical rooms.

D5040 ACCESS CONTROL MANAGEMENT

1. The Access Control System shall be the BASIS Access Control Management System so as to interface into the existing BASIS Access/Cougar One Card System. System shall be provided by Stanley Convergent Security Solutions, Inc., Contact: Mr. Terry Clymer, Ph.: 832-289-4538, Fax 713-861-7808, Terry.Clymer@sbdinc.com. Full system specifications may also be obtained from this contact or from the UH Access Control Shop.
2. Access Control Contractor shall provide and install all low voltage plenum cabling to access control devices and electrified door hardware, and make all low voltage connections. All low voltage cabling must meet or exceed UH standard for low voltage cabling installation.
3. Access Control Contractor shall provide door lock power supplies if not provided with door hardware for all devices and supporting devices. Power supply for latch retraction must be the same manufacturer as the exit devices.
4. Access Control Contractor shall provide specified BASIS client software (if specified), and associated training.

5. The UH Department of Public Safety/ Electronic Access Control Manager shall indicate which of the following typical locations: doors, frames and door hardware, elevators, automatic doors, and building entrances shall be equipped with the access control management system. See also B2031 Exterior Door Hardware and C1025 Interior Door Hardware.
6. Access control equipment may include magnetic stripe and proximity card readers, intelligent system controllers, system enclosures, input panels, output panels, interface relays, power distribution modules, door contacts, egress motion detectors, exit buttons, RTE hardware at exit-only doors, door prop horns, key switches, system power supplies, fused relay outputs, back up batteries, and power distribution modules for fail-safe locks only (to be tied into the building fire alarm system).
7. Submittals for the access control management shall be integrated with submittals for the components into which the access control equipment shall be incorporated (e.g. frames, elevators) to ensure the design intent of the system/assembly is completely understood and can be reviewed together. All access control installation doors require adequate submittals be submitted prior to commissioning of door.
8. Distributor shall program all system and door set up information. All programming standards shall meet Programming Standards created and approved on 09/10/2016. Owner shall program all cardholders and access levels and provide final door labeling information for programming.
9. Eye readers may be used in-conjunction with Mag-swipe readers with special approval from Assistant VC/VP, Public Safety and Security including the UH Access Control Shop and Electronic Access Control Manager.
10. All Access Control Panels will be tied into buildings Life Safety (back-up) Generator when applicable.

D5090 EMERGENCY GENERATORS

1. Emergency generators must meet the conditions of the Texas Commission on Environmental Quality (TCEQ) by rule or be individually permitted. City of Houston requirements that all tanks installed in its jurisdiction shall be UL 2085 listed tanks which are fire rated and double walled
2. Best practice is to use natural gas fueled emergency generators. If fuels other than natural gas are used for emergency generators, tanks must be double-walled; tanks larger than 1,100 gallons require registration to TCEQ. Contact Environmental Health & Safety for assistance.

3. All new generators installed on the UH campus must have engines that comply with current provisions of Part 40 Code of Federal Regulations (CFR) 89.102 for Tier 1 emission limits.
4. All emergency generators must be equipped with a non-reset run meter. Testing of generators is prohibited from 6:00 am to 12:00 pm in Harris County, unless they are operating under emergency conditions.

ELEMENT E

E10 EQUIPMENT

E1090 SPECIAL EQUIPMENT

1. Areas in which commercial kitchen equipment will be located shall have adequate space between adjacent equipment and equipment and the wall to allow for maintenance and cleaning. Whenever possible, equipment shall be on locking casters to permit maintenance or cleaning). Equipment on wheels shall be anchored.

E20 FURNISHINGS (NOT USED)

ELEMENT F

F10 SPECIAL CONSTRUCTION

F1010 SPECIAL CONSTRUCTION-DUMPSTERS

1. The site design for new facilities shall include an enclosed dumpster area. Dumpster locations shall provide convenient and access to vehicles emptying the dumpster, shall be in less visible areas of the site, and shall be screenable by planting, fences and/or walls. Chain-link fencing shall not be used.
2. Dumpsters shall be located on pads. Dumpster pads shall feature positive drainage to prevent standing water, and areas surrounding dumpster pad shall feature positive drainage away from the dumpster pad.
3. Sanitation trucks shall be able to approach the dumpster enclosure in a straightforward direction, align with the dumpster, reverse away (T-turnaround or similar) from the dumpster enclosure and exit the site. It is preferable that trucks do not have to back out of the site or make a 360 degree turn to exit the site.

ELEMENT G

BUILDING SITEWORK

G10 SITE PREPARATION

G1000 GENERAL [NOT USED]

G1001 COMPLIANCE WITH THE TEXAS UNDERGROUND UTILITY LOCATION PROGRAM

1. Texas law requires all excavators using mechanical tools to provide advance notice prior to digging, excluding weekends and holidays. Proper notification requires an excavator engaged on University of Houston projects to contact UH Utility Services and Lone Star Notification Center of a planned excavation no more than fourteen days and no less than forty-eight hours before the excavation (s) is/are expected to commence.
2. Excavators engaged on campus projects shall enter the project information on two faxable forms, which may be obtained through the FP&C Project Manager assigned to the project or from Utility Services (713-743-5791).

G1002 TOPOGRAPHIC ELEVATIONS

1. All elevations shown on site plans, floor plans (architectural, structural, HVAC and electrical), building elevations, wall sections, details, etc. shall be actual elevation above mean sea level (USC & GS or datum mandated by local governing authorities) as provided by the survey data.

G1005 TRASH REMOVAL

1. Trash receptacle locations should be at grade level and should be placed so that the receptacle can be loaded from top as well as side. The receptacle location should be screened from public view. Where the receptacle location is integral with the building it should be screened in a manner consistent with the general building design. Verify method of disposal (front loading or rear loading trucks). at each building with UH and FP&C/FM
2. Trash receptacle area should be adequately lighted for night use.
3. At receptacle locations, provide a reinforced concrete pad of sufficient size and strength to accommodate the receptacle and truck.
4. Where the receptacle location is integral with the building all associated stoops, porches, docks, and steps, exterior and interior should have built-in abrasive surfaces. Slope exterior porches and treads to drain water $\frac{1}{4}$ " per foot. Exposed concrete finish work shall be accomplished in two pours; the first being structural,

and the second being a two inch minimum finish topping poured near completion of project.

G1010 SITE CLEARING

G1011 EXISTING TREE PROTECTION

Prior to the start of construction activities, the Contractor will submit a Tree Protection Plan to the Project Manager for review by the Tree Campus USA committee. The plan shall include the location of the protection barriers at the Tree Protection Zones (TPZ) of individual trees or dripline (whichever is greater) or at the outermost driplines of clumps of trees. The plan shall also include a tree maintenance plan and tree preservation standards for the construction period. Tree preservation methods shall comply with ANSI A300-part 5.

G1020 SITE DEMOLITION AND RELOCATIONS

G1021 EXISTING TREE RELOCATION

Many trees on the UH campus are of an age that will allow for relocation. Such trees will be relocated from the site, if necessary, to locations elsewhere on the campus as determined by FP&C/FM. Some existing trees on the campus should be relocated for the maximum health of earlier plantings. These trees should be incorporated into the site design if possible. FP&C/FM will designate such trees. Existing trees should be relocated only in late fall and winter; they should be watered and cared for a year.

Some trees on the campus have been planted in honor of or in memory of someone. If these trees must be relocated or removed, the dedication device must be relocated with the tree or reinstalled with the replacement tree. The UH will coordinate this effort with the donor if known.

G1022 EXISTING TREE REMOVAL AND REPLACEMENT

When planning new construction, when it is not possible to mitigate tree removal due to budget or site constraints, a tree survey will be required as part of the project survey. Existing site trees will be identified by location, caliper size and species. The demolition plan shall clearly indicate which trees will be relocated and which ones will be removed. Removed trees will be required to be replaced. Replacement trees shall match or exceed caliper inch per caliper inch of removed trees and shall have a minimum caliper of 4" at installation.

If space to plant similarly calipered trees does not exist, (with the approval of the UH Landscape Project Manager) larger caliper trees may also be used or replacement trees may be located on alternate sites. The Grounds Manager, in consultation with the Landscape Project Manager and Tree Campus USA committee shall approve replacement tree species and size.

G1030 SITE EARTHWORK Refer to SECTION 7.0 SUSTAINABLE DESIGN GUIDELINES.

G20 SITE IMPROVEMENTS

G2000 GENERAL [NOT USED]

G2010 ROADWAYS

Streets and related subterranean storm drainage are to be designed and constructed in accordance with City of Houston Standards.

G2020 PARKING LOTS Refer to SECTION 9.0 PARKING STANDARDS AND GUIDELINES and Master Construction Specifications Division 32.

G2030 PEDESTRIAN PAVING Refer to SECTION 6.0 LANDSCAPE DESIGN GUIDELINES, SECTION 9.0 PARKING STANDARDS AND GUIDELINES, and Master Construction Specifications Division 32.

G2040 SITE IDENTIFICATION

1. Free standing exterior building identification to be provided by UH. Refer to SECTION 10.0 WAYFINDING STANDARDS AND GUIDELINES.

G2050 LANDSCAPING Refer to SECTION 5.0 LANDSCAPE DESIGN GUIDELINES and Master Construction Specifications Division 32.

G2052 EROSION CONTROL MEASURES

A construction project which disturbs more than 1 ACRE of land must follow the Texas Commission on Environmental Quality (TCEQ) General Permit to Discharge Storm Water from Construction Sites. If less than 1 acre is disturbed the project is exempt from the permit requirements.

For a more complete description of principles of storm water management for construction activities at the University of Houston, refer to:

<http://www.uh.edu/ehs/environmental/water/checklist/>

G403006 SURVEILLANCE CAMERAS

1. General:
 - a. Refer to Master Specification Section 28 23 00 for for installation requirements and approved camera product lines.

Refer to <http://www.uh.edu/infotech/services/computing/networks/network-infra-standards/index.php> for UIT cabling standards, camera specifications and additional use requirements.
2. Location and Coverage:
 - a. Cameras at all ingress points to buildings providing a high resolution view of faces as they enter the facility. Cameras at egress points showing activity detection with adequate resolution to reconcile subjects recorded by

ingress cameras. Activity detection cameras in public hallways shall show an individual's movement within the building.

- b. Classrooms: Generally there will be no cameras in classrooms.
 - c. Research space: Cameras shall show persons exiting the research facility in high detail resolution. Cameras in the hallways shall show the movement of persons within the research facility. Cameras shall only be employed within the research spaces themselves only when there is a need to monitor the health and safety of the researchers.
 - d. Administrative space: Cameras shall be installed in the hallways and shall show movement of persons in the building.
 - e. Residential spaces: Cameras shall be located to show activity in the common areas, including lounges, laundry, computer labs, etc. No cameras shall be located within in the bedroom units.
 - f. Point-of-Sale and cashier areas: Cameras shall be located to show patrons' faces in high detail resolution at the Point-of-Sale.
 - g. Surface parking lots and campus roadways: Cameras shall be located so as to provide general activity detection throughout designated areas. Cameras capable of capturing clear images of license plates as well as vehicle colors, during the day, and vehicle makes and models, day or night, shall be installed at designated parking lot entrances and exits; and at designated locations on campus roadways.
 - h. Parking structures: Cameras shall be located so as to provide general activity detection throughout designated areas. Cameras capable of capturing clear images of license plates as well as vehicle colors, during the day, and vehicle makes and models, day or night, shall be installed at designated parking lot entrances and exits.
- 3.
- a. High resolution or facial identification cameras shall be capable of achieving 100 pixels per foot at the point of interest. Camera models and lens specifications will be determined using this value.
 - b. Activity detection cameras will be capable of achieving 20 pixels per foot at the far end of the coverage area.
 - c. License plate reader cameras will be capable of at least 60 pixels per foot.
4. Frames per second and shutter speeds
- a. Facial identification and LPR cameras will be set at 10 frames per second with shutter speeds of 1/1000 seconds.
 - b. Activity detection cameras will be set at 5 frames per second with shutter speeds of 1/1000 seconds.

5. Archive Durations:
 - a. All NVR recorded footage will have an archive duration of at least 14 days.
 - b. LPR cameras data captures will be archived for at least a year.

SECTION 12.0a

CONSTRUCTION SYSTEMS AND ASSEMBLIES STANDARDS AND GUIDELINES

ADDENDUM A: LABORATORY BUILDINGS

INTRODUCTION

Laboratory buildings call for special guidelines and standards in addition to those that apply to all buildings. These guidelines are presented in the format of an addendum to the fundamental SECTION 12.0, so the written structure mirrors the UniFormat style of SECTION 12.0. As in Section 12.0, the UniFormat structure is shown even if, at present, there is no information in some elements and sections.

FACILITY PERFORMANCE

A Basic Function, Research Labs:

- 1 Design basic modular lab plans or generic labs which, over time, permit accommodation of a wide variety of research functions.
- 2 Design all research modules as generic labs with generic services; then minimally modify a specific lab to support that user's unique requirements. FP&C with the design consultant will determine the requirements for the generic module.
- 3 Design the lab module for flexibility or adaptability to accommodate future changes in research functions with a minimum of remodeling and renovation expense.
- 4 Future remodeling of a lab should have minimal effect on adjacent labs and adjacent research programs.
- 5 Provide functional relationships among principle activities, work space, offices, core support and services which support the research program.
- 6 Provide material management and movement that support the research program while protecting the adjacent research programs.
- 7 Provide waste management, holding, movement and disposal that support the research while protecting the public.
- 8 Provide zones within the design for special environmental requirements such as vibration, radiation, EMF, shielding, clean rooms and microwave. Provide communities or pods of faculty offices distributed throughout the lab facilities.
- 9 Group spaces with the most intense requirements for mechanical, electrical, and plumbing to reduce construction as well as operational costs.
- 10 Consider ceiling supplied services with no floor penetrations.

B Basic function, Teaching Labs:

- 1 Design teaching labs that facilitate flexible scheduling by supporting a variety of academic disciplines and teaching styles. Confirm with FP&C the facility parameters needed to match the intended educational program. In the interim, use the following guidelines for preliminary design.
- 2 Design for 20 to 32 student workstations for introductory courses and 20 to 24 student workstations for advanced courses.
- 3 Provide standing height benches for chemistry; consider sitting height benches for biology.
- 4 Provide each student with 3 to 4 linear feet of bench; two students will share a 5 or 6 foot hood and 4 students will share a sink.
- 5 Provide one network connection on the bench for every two students.
- 6 Design lab for student working groups of 2 or 4. Lab bench arrangement and spacing should encourage both student and faculty movement and interaction.
- 7 Provide each Lab with 10 to 20 linear feet of wall storage, plus support equipment required for that discipline; refrigerators, incubators, ovens, demonstration apparatus.
- 8 Shared instrumentation benches or shared instrumentation rooms between labs are appropriate.
- 9 Design the lab to allow gathering space for the students near the demonstration table. The bench layout should encourage interaction and informal conversation between instructor and students.
- 10 Provide good sightlines throughout teaching labs particularly for hoods. Visual control by faculty within the labs is required.
- 11 Close proximity between hood and benches increases student safety.
- 12 Consider shared pre-lab lecture rooms or discussion rooms adjacent to labs. Consider interference with lecturer from hood noise.
- 13 Determine FP&C expectations of durability balanced with cost in the selection of lab bench materials.
- 14 Countertops of lighter colors increase illumination.
- 15 Location of research labs adjacent or contiguous to teaching labs provides ability to share instrument rooms, equipment rooms, prep rooms, storage rooms, animal facilities, electron microscopes, and tissue culture.
- 16 Provide each teaching lab with network connections, ceiling mounted projectors and projection screens; consider CRT or LCD monitors suspended above workstations.

C Health and Safety:

- 1 Laboratory design must be approved by UH Department of Public Safety and Department of Environmental Health and Risk Management.
- 2 All labs that house more than two people will have two exits.
- 3 With the concurrence of the UH Department of Public Safety and Department of Environmental Health and Risk Management, provide quick-connect/disconnect outlets for emergency breathing air, or self-contained backpacks, at strategic locations throughout laboratory work areas.
- 4 Provide emergency eye or combination eye and face washers in each lab, preferably at each major sink (cup sinks excluded). Minimum flow pressure at 20 psi, maximum static pressure at 125 psi, water temperature range at 60 deg. to 95 deg. F, and flow rate between 2.5 and 12 gpm. Provide alarm system when emergency washer is activated.
- 5 Provide emergency deluge stations in corridors serving several research labs. Provide deluge stations near the entry to all teaching labs. Floor drains shall not be provided. See Section 12. CONSTRUCTION SYSTEMS AND ASSEMBLIES STANDARDS AND GUIDELINES D2010.90 for additional emergency shower requirements.
- 6 Provide fire suppression appropriate to the anticipated activities. All labs and chemical storage will be fire sprinklered. Provide smoke and flame detectors connected to the building alarm system. Provide portable alarm, warning, and monitoring systems if hazard warrants (e.g., hydrogen or hydrogen sulfide). Provide fire extinguishers (ABC class, dry and liquid) in all labs and storage rooms. Provide fire blanket at exit door from each lab and fire cover storage cabinets if advised by FP&C.
- 7 Provide on each floor, or within each fire zone of each floor, first-aid supply cabinets and emergency equipment carts if advised by FP&C.
- 8 Provide gas cylinder brackets, retainers, holders, stands, and manifold distribution systems for locations identified by FP&C.
- 9 Provide battery-powered, trickle-charged emergency stair and corridor lighting units in addition to lighting that may be on the emergency power generator system.
- 10 Label all pipes, conduits, ducts, etc., with industry standard graphics to identify the contents and direction of flow.
- 11 Provide access panels, cleanout panels, or inspection panels that contain a small view port to permit a visual check before opening.
- 12 Consult with UH Department of Environmental Health and Risk Management (EHLS) regarding appropriate signage and provisions for hazardous waste.
- 13 Provide storage space for chemical spill response containment materials and cleanup requirements, including tools, utensils, and spill-response materials and equipment carts.

- 14 Consult with EHLS regarding requirements for gas mask storage cabinets in laboratory work areas that may generate organic vapors, dusts, fumes, smoke, and mists from chlorine, acid gases, hydrogen cyanide, ethylene oxide, ammonia, etc. EHLS will advise the design consultant on appropriate required storage and locations.
- 15 Consult with EHLS regarding requirements for protective suits and clothing, coveralls, foot and head gear, boots, hard hats, gloves, soiled protective gear, and contaminated protective gear. EHLS will advise the design consultant on appropriate required storage and locations.
- 16 Vented Storage Cabinets.
- a. Vented safety storage cabinets for acids and corrosives can be in the base cabinet for the fume hoods in laboratory work areas. Vents for the cabinets may be into the fume hood or into the exhaust duct directly.
 - b. Solvents and flammable liquids should be stored in vented and fire-rated cabinets (but not in hood base cabinets) and vented directly into exhaust ducts.
 - c. Hazardous waste storage cabinets, drums, and other containers, and safety containers for storage and disposal of reagents and hazardous waste must be vented into the exhaust duct directly.
 - d. Large volumes of flammables may be stored outdoors in approved storage units if protected and secured.
 - e. No more than three cabinets may be located in a single fire area. NFPA 30, Section 4-3-1. No more than 60 gal may be class I and class II liquids, nor more than 120 gal of Class III liquids be stored in a storage cabinet.
 - f. Metal safety cabinet will comply with: OSHA 29 CFR 1910.106(d)(3) and NFPA 30, Chapter 4, Sections 4-3.2 and 4-3.2.1. The Uniform Fire Code 79.202 requires the same as OSHA 29 CFR 1910.106 and NFPA 30.
 - g. Bench cabinets are available to store small amounts of flammables and corrosives under the laboratory work bench. Mobile safety cabinets are also available in compliance with OSHA 29 CFR 1910.106 and NFPA 30 regulations.
 - h. Type I and Type II safety cans must comply with Department of Transportation (DOT) 19L and Un 1A1/Y/100/92 requirements for storage and use of hazardous and flammable liquids in the laboratory.

Liquid Flammables and Combustibles Classifications

Class	Flash Point (°F)	Boiling Point (°F)
Flammables	IA	< 100
IB	< 73	> 100
IC	> 73 and < 100	
Combustibles	II	> 100 and < 140
IIIA	> 140 and < 200	
IIIB	> 200	

Maximum Storage Quantities for Cabinets

Liquid Classification	Maximum Storage Capacity (gal)
Flammable, class I	60
Combustible, class II	60
Combustible, class III	120
Combination of classes	120 _a

D Physical Security:

- 1 Partitions enclosing chemical storage rooms and hazardous areas will run to structure and be sealed at top and bottom. Fire-rating of construction will be adequate to protect for the hazard per code or as directed by FP&C. Large chemical storage rooms inside the building will be reinforced CMU.
- 2 All doors in chemical storage rooms, preparation rooms and hazardous areas will be self-closing and locking with door position switches.
- 3 Research Labs will be locked. FP&C will advise the requirements.
- 4 Teaching Labs will be locked. FP&C will advise the requirements.

E Operation and Maintenance:

- 1 All labs will be individually circuited, valved, and isolated so that cutting off services to one lab will not affect operations in other labs.
- 2 All chases which contain vent stacks will be physically accessible with adequate room so inspectors may enter the chase and visually inspect from all sides.

ELEMENT A

SUBSTRUCTURE

There is no special information in ELEMENT A. Refer to SECTION 12.0.

ELEMENT B

STRUCTURE

There is no special information in ELEMENT B. Refer to SECTION 12.0.

ELEMENT C

INTERIORS

C10 INTERIOR CONSTRUCTION

C1000 GENERAL. Refer to SECTION 12.0.

C1010 PARTITIONS

Use any of the following types of partitions:

- 1 Gyp board with semi gloss paint.
- 2 Provide partitions to structure between each lab.
- 3 Reinforced CMU partitions around hazard or chemical storage rooms.
- 4 CMU with block filler and epoxy paint at green house or animal holding rooms

C1020 INTERIOR DOORS

- 1 Provide 4'-0" double opening (1'-0" and 3'-0" doors) at all lab entries.
- 2 Provide a minimum 6 inch by 18 inch vision panel in all doors other than offices and restrooms.
- 3 All doors to labs and hazardous areas will be self-closing and self-locking.
- 4 Galvanize all metal doors and frames.
- 5 All doors serving labs will be plastic laminate.

C1025 INTERIOR DOOR HARDWARE. Refer To SECTION 12.0.

C3010 WALL FINISHES

- 1 Flooring:
 - a. Teaching labs floors will be VCT.
 - b. Research Lab floors for Chemistry, Physics, and Engineering will be VCT.
 - c. Research lab floors for biology will be seamless flooring.
 - d. Greenhouse and animal holding floors will be seamless epoxy resin floors
 - e. Consider sealed concrete for alternate lab and storage area flooring.
- 2 Walls will be any of the following:
 - a. Use semi-gloss paint for labs, store rooms, and offices
 - b. Use epoxy paint for greenhouses and animal holding and biological rooms
 - c. Consider epoxy paint for other special use labs
- 3 Ceilings will be one of the following:

- a. Use 2x2 vinyl-coated acoustical tile.
 - b. Use suspended green board drywall ceiling in greenhouse and animal holding areas.
- 4 Casework:
- a. Use wood construction, oak veneer, light finish
 - b. Use white tops, material appropriate to chemical resistance required by activities

ELEMENT D SERVICES

D1000 GENERAL

- 1 Oversize the mechanical rooms, spaces and chases to accommodate initial level of service and allow for future growth and additions.
- 2 Insure flexibility in the design of building systems and the space allowed for installation and maintenance to permit ease of changing functions, activities, equipment and regulations.
- 3 Flexibility depends upon the capacity of building systems while changeability depends on the organization and location of the system elements. Optimize the design of systems for optimal balance between these to obtain approval from FP&C.

D20 PLUMBING

D2000 GENERAL

- 1 Organize piped services in overhead lanes or chases for uniformity of service and ease of access and provide taps and valves located for potential drops to benches and hoods.
- 2 Consult with EHLS regarding acid waste piping from designated sinks diverted to a neutralizing basin or holding tank for dilution, pH adjustment, and disposal. FP&C will advise on glass vs. plastic piping systems.
- 3 Consult with EHLS regarding diverting biohazard liquid waste to holding and processing tanks before being released in the sanitary sewer systems or removed for alternative disposal process. A two-tank system may have to be installed (one to process waste and one to hold waste awaiting processing or removal).
- 4 Consult with EHLS regarding providing carbon dioxide, nitrogen, oxygen, helium, or other special or mixed gases piping systems including manifolds, valves, and regulators and pressure sensors if required by FP&C. Gases may be supplied to individual workstations from portable gas cylinders mounted/restrained in the laboratory work areas, or from central gas cylinder rooms or a service corridor. Design the manifold and distribution system with the lab programmer.
- 5 Provide lab quality, oil-free central compressed air supplied at pressures between 40 to 150 psi as defined by FP&C with pressure regulators, filters, dryers, as may be required. Confirm with FP&C if a secondary system of lesser quality air may be required in addition.

- 6 Provide central natural gas system. Sleeve per code any pipe enclosed in unventilated spaces such as walls, chases, or ceilings. Pipe run in return air plenums may be unsleeved.
- 7 Breathing-quality air may be required at selected locations throughout the laboratory work areas for safety and emergency rescue protocols. Comply with any codes or as directed by FP&C and coordinate with the fire department's rescue practices.
- 8 If desired by FP&C, provide a central vacuum system operating at 18" to 22" (ordinary) to 28.5" (high) of mercury. Locate fixtures as directed by FP&C, but initial planning should anticipate outlets at each hood and one per bench face. Vacuum to be filtered when installed in high-hazard laboratories.
- 9 If cup sinks are preferred on benches (generally allows more unimpeded surface for equipment), locate one per 8-10 feet of countertop. Provide single rigid or vacuum-breaker gooseneck faucet for cold water with straight serrated hose connector.
- 10 Where drain troughs are preferred (perhaps in teaching labs), provide troughs min. 6" wide x 4" sloping to 8" deep (function of length) and composed of acid-resistant composite material.
- 11 Provide an emergency deluge shower head and eye wash in all laboratory areas with chemical fume hoods. Locate near the primary exit.
- 12 Provide hot (120 to 140 deg. F) and cold water at each laboratory utility sink with a mixing type rigid or vacuum-breaker gooseneck faucet with straight serrated hose connector. Faucets actuated by arm handles, wrist blades, knee action, or foot controls or automatic devices.
- 13 Confirm requirements for distilled or de-ionized water at the utility sink(s), in fume hoods, in preparation areas, etc., and use special plastic fixtures and piping to meet purity requirements.
- 14 Provide at a minimum one single-tub utility sink of acid-resistant composite materials per laboratory module.

D3040 HEATING VENTILATING & AIR CONDITIONING

- 1 In general, all laboratory work areas will be maintained at negative pressure relative to corridors and adjacent spaces. Special laboratory environments may require an equal or positive-pressure environment.
- 2 Provide individual thermostat controls for all laboratory work areas.
- 3 Maintain a minimum of 6 air changes per hour for all laboratory work areas, but confirm with FP&C any higher levels that may be required by specific environments. See also *Section 12.0 A.01 Laboratory Design Guide, 1.1.C.8.*
- 4 Confirm with FP&C any requirements for air filtration in specific laboratory areas that exceed capabilities of normal "dust only" filters in air handling units.
- 5 Design the HVAC system to permit supplemental cooling by fan coil units in laboratory modules that contain special equipment, develop high heat loads, etc.
- 6 All laboratory work areas, service and support spaces, and animal facilities will be served with 100% outside air supply and 100% exhaust.

- 7 Location of fresh air intakes relative to the exhaust stacks is a critical item. Consider air flow and turbulence studies to verify intake locations and exhaust diffusion effectiveness. Consider other sources of air contamination such as truck exhausts at loading docks, downwind of exhaust streams from nearby facilities (e.g., labs and kitchens).

D40 FIRE SUPPRESSION SYSTEMS

D4000 GENERAL

- 1 Provide wet-pipe fire sprinkler systems throughout the entire building.
- 2 Work with the UH Department of Public Safety, EHLS and users to identify locations for life safety and emergency systems, fire and smoke containment, spill containment, eyewash and showers, supplemental breathing apparatus, etc.

D50 ELECTRICAL

D5000 GENERAL

- 1 Provide clean “normal” power and emergency power sources for each lab and equipment area. Consider with FP&C whether to provide a central UPS or provisions for local systems in each lab and equipment area versus installing local devices on each piece of equipment.
- 2 Consider combination direct and indirect pendant fluorescent light fixtures to provide 70 to 100 fc (based on activity) at standing work counter height (36”) supplemented with task lighting. Verify actual lighting requirements in each lab with users.
- 3 As a beginning point, assume connected load design capacity between 60 and 100 VA/nsf in laboratory work areas only. Service levels may be considerably higher (several hundred VA/nsf) in electronics and production laboratory work areas. Equivalent of 50 W/nsf minimum in laboratory work areas only.
- 4 Provide in each laboratory work area an accessible electrical panel to distribute electrical power. Locate panel either in the corridor by each door or just inside the door. Also, consider emergency cut off switches (red “mushroom” buttons) at the exit doors from each lab. Standard electrical service should be a bus duct system, 120v/208v panel-board, single and three phase, four-wire, 60-hertz current, with 25-35% excess capacity minimum.
- 5 Provide explosion-proof light fixtures, switches, and receptacles in laboratories and fume hoods using highly reactive, volatile, or explosive substances. Confirm locations, quantities, and types with FP&C.
- 6 Provide a bus grounding bar connected to a special building ground grid system in each laboratory module for instruments and equipment requiring an absolute ground. Provide testing reports for each lab.
- 7 For initial planning, assume a minimum of one emergency electrical power outlet on each side of the laboratory work area module line or partition centerline, 1200 to 1500 W capacity.
- 8 Provide smoke and flame detectors in each laboratory work area and in service and support areas. Confirm with FP&C the need for special sensors for hazardous materials.

- 9 Anticipate one 208-V single-phase three-wire polarized grounded outlet per bench face and at each hood.
- 10 Anticipate at a minimum one 120-V three-wire polarized grounding duplex outlet per 3 feet of counter. Confirm with UH the need for all outlets to be GFCI, but at a minimum provide these in the vicinity of any sinks or equipment using liquids.

D5030 TELECOMMUNICATIONS

- 1 See other sections for telecommunications wiring and outlet requirements. But at a minimum anticipate one data network connection per bench face and a voice/data outlet at each researcher workstation.

ELEMENT E EQUIPMENT AND FURNISHINGS

E10 FUME HOODS

E1000 GENERAL

- 1 Locate fume hoods away from circulation without dead end configurations.
- 2 All Laboratory hoods shall meet the requirements of the National Fire Codes, NFPA 45, Fire Protection for Laboratories Using Chemicals. Hoods handling radioactive material shall also meet the requirements of NFPA 801, Recommended Fire Protection Practice for Facilities Handling Radioactive Materials.
- 3 Hoods shall be variable volume and an integral part of the HVAC system design.
- 4 Hood lighting should be vapor or explosion proof; light bulbs will be changeable from outside of the hood.
- 5 Hood liner materials should be matched to the anticipated substances and procedures.
- 6 Airflow distribution within a hood is better attained with adjustable type slots. Movable panels or baffle plates are not recommended.
- 7 The working surface of a hood should include a raised front lip for spill control.
- 8 Perchloric acid hoods require a “wash down” feature in which water spray is used to remove acid crystals from the exhaust fan, ductwork, and hood plenum after each use.
- 9 Consult with EHLS regarding radioisotope hoods installations. These air stream systems require special construction to permit easy cleaning. Filtration requirements of the exhaust air and fume hood construction shall be determined on a case by case basis in consultation with FP&C.

- 10 Biological safety cabinets (BSC's) shall meet NIH 03-112C Performance Specifications and shall be in accordance with National Sanitation Foundation Standard NSF49 and be listed by N.S.F. For application guidelines and filtration requirements use HHS Publication No. (CDC) 93-8395 "Biosafety in Microbiological and Biomedical Laboratories". Unit shall be of coated steel or stainless steel construction; interior shall be stainless steel with coved corners. All seams and welds to be ground smooth and polished. Sliding view window shall be ¼" safety or tempered glass. Supply and exhaust HEPA filters shall be front loading and shall be 99.99% efficient for 0.3 micron sized particles. Unit shall be listed by UL or CSA for electrical services to be provided per the end user. Unit shall include fluorescent light and an ultraviolet (germicidal) light. Certification of unit after installation is required and must be performed by an approved certification company.
- 11 Hood sash will have a positive stop at approximately 60% open and required exhaust air volume and velocity shall be determined at this position. Provide an alarm and/or flashing red light to be activated whenever this stop is bypassed.
- 12 Average face velocity for all hoods with sash 60% open will be 100 fpm and minimum at any point 80 fpm (standard specifications allow a 20% variance at any one spot as long as no eddying or backflow occurs).
- 13 Exhausts from fume hoods may be designed with either an independent duct system for each hood or a manifold system. Consider a variable volume manifolded system where mixing of the exhaust is not a problem. *[See Section 12.0 Addendum A.01 for additional ducting restrictions]*
- 14 A high transport velocity (1500-2000 feet per minute) is needed so that dust and aerosol-size materials are not deposited in the joints, cracks, or corners in the duct system.
- 15 Exhaust ducts will be constructed of Type 316L Stainless Steel with all-welded or mechanically fastened joints sealed with mineral impregnated woven fiber tape which is further impregnated with an activator/adhesive of the polyvinyl acetate type such as manufactured by Hardcast, Inc. or equal. Ducts shall be routed vertically with minimum number of returns. All hood exhaust outlets shall be flanged and furnished with a companion flange for welding to the exhaust duct.
- 16 The exhaust fan assembly shall be located on the roof. The fan will be belt-driven with exhaust directed vertically at a velocity sufficient to clear the building and all other obstructions (min. 2500ft. per minute exit velocity). The open end shall be a minimum of 10'-0" above roof or walking surface or more as directed by local codes or UH. Exhaust fan shall consist of monel wheel and cast iron housing, coated with three coats of air dried "Herzite." Motor shall be outside of the air stream in a galvanized enclosure.
- 17 Hood exhaust system design must provide for 10% minimum flow through exhaust duct when hood is not in service. The hood exhaust may be used as part or all of the required exhaust from the laboratory room.
- 18 Avoid pressurized exhaust ducts. Fans blowing into the duct system will not be permitted.

E11 FUME HOOD TESTING

E1100 GENERAL

- 1 All fume hoods must be tested per requirements of ASHRAE Standard 110-1995. Each hood will be tested at the factory before acceptance for shipping and also after installation before acceptance of the laboratory.
- 2 Tests at the factory will be conducted by the manufacturer's quality control staff, with complete documentation supplied to FP&C and the design consultant. At a minimum, a selected group of hoods representing each of the types of hoods in the project will be observed in testing at the factory by a representative of FP&C, the design consultant, and the contractor. More observers may be included at the discretion of FP&C and the project team.
- 3 Each hood will be tested after installation and after the HVAC systems have been balanced. These tests will be conducted by an independent testing agency that is experienced in fume hood performance testing. It is recommended that representatives of FP&C, the design consultant, contractor, mechanical engineer, and manufacturer will observe the tests.
- 4 Factory testing will include all three component tests described in the ASHRAE standard, including the tracer gas method. Field testing in the laboratory need not include the tracer gas test unless required by FP&C for special hazard conditions.
- 5 The following is an abbreviated version of ASHRAE 110-1995 provided by Fisher Hamilton, a major manufacturer of fume hoods, as part of its standard specifications. Other manufacturers supply similar standards and all should subscribe to the ASHRAE 100-1995. This document is included as a guideline but the full ASHRAE 110-1995 should govern all tests.

E1110 SOURCE QUALITY CONTROL TESTING OF FUME HOODS

- 1 Evaluation of manufacturer's standard product shall take place in manufacturer's own test facility, with testing personnel, samples, apparatus, instruments, and test materials supplied by the manufacturer at no cost to the University.
- 2 Submit test report consisting of the following test parameters and equipment for each hood width and configuration specified.
- 3 Hood shall achieve a rating of 4.0 AM 0.1 P.P.M. or better. Tested to ASHRAE-110-R.
- 4 front of fume hood. Provide make-up air to replace room air exhausted through fume hood and to obtain a negative 0.2" w.g. room pressure. Introduce make-up air in a manner that minimizes drafts in front of hood to less than 20% of the face velocity. Connect 100 feet per minute air velocity through face of fume hood. Adjustment in blower shall vary face velocity down to 75 feet per minute.
 - a. Examine facility to verify conformance to the requirements of this Section.
 - b. Test room shall be isolated from all personnel during test procedure.
- 5 Provide the following for testing of auxiliary air fume hoods:

- a. Control room temperature and maintain quantity of auxiliary air sufficient to meet the manufacturer's stated ratio of auxiliary air to exhaust air.
- 6 Provide the following for testing of Vectrol fume hoods:
- a. Maintain temperature of auxiliary air 10 degrees F. above room temperature.
- 7 Testing equipment:
- a. Properly calibrated hot wire thermal anemometer probes equal to Sierra Model 600-02; correlate with computer data acquisition format to provide simultaneous readings at all points.
 - b. Pitot tube and inclined manometer with graduations no greater than 0.2 inch of water, equal to F.W. Dwyer Model 400. Calibration curves based on 20. Pitot traverse readings and correlated to a digital readout indicator to provide quick and accurate adjustment of air flows.
 - c. Tracer gas: Sulfur hexa-fluoride supplied from a cylinder at a test flow rate of four liters per minute.
 - d. Ejector system: Tracer gas ejector equal to IHE No. 525-014. Submit sufficient proof of ejector system calibration.
 - e. Critical orifice: Sized to provide tracer gas at four liters per minute at an upstream pressure of 30 PSIG.
 - f. Detection instruments: Ion Track Model 61 Leak Meter II sulfur hexafluoride detector instrument.
 - g. Recorder with an accuracy better than plus or minus 0.5% of full scale.
 - h. Three dimensional manikin, overall height 67", clothed in a smock.
 - i. Titanium tetrachloride glass modules. CAUTION: Titanium tetrachloride is corrosive and irritating; skin contact or inhalation shall be avoided.
 - j. One dozen 30-second smoke bombs.
- 8 Preliminary Test and Data:
- a. Provide sketch of room indicating room layout, location of significant equipment, including test hood and other hoods. Provide sketch of air supply system indicating type of supply fixtures.
 - b. Reverse air flows and dead space:
 - i. Swab strip of titanium tetrachloride along both walls and floor of hood in a line 6" behind and parallel to the hood face, and along the top of the face opening. Swab an 8" diameter circle on the back of the hood. All smoke should be carried to the back of the hood and exhausted.
 - ii. Test the operation of the bottom air bypass air foil by running the cotton swab under the air foil.

- iii. If visible fumes flow out of the front of the hood, the hood fails the test and receives no rating.
 - c. Face velocity measurements: Face velocity shall be determined by averaging minimum of four and maximum of eight readings at the hood face. Take readings at center of a grid made up of sections of equal area across the top half of the face and sections of equal area across the bottom half of the face. Take simultaneous readings at each point with a series of calibrated hot wire anemometers over a one minute period of time. Probes shall be correlated to a computer data acquisition package, which will provide an average of each reading over that one minute period and also an overall average. During the one minute monitoring period, all velocities must automatically update average at a maximum of four second intervals.
- 9 Test Procedure:
- a. Check sash operation by moving sash through its full travel. Verify that sash operation is smooth and easy, and that vertical rising sash shall hold at any height without creeping up or down. Position sash in the full open position.
 - b. Measure exhaust air flow with the baffles' position to give maximum air flow. Measure exhaust air volume with baffles' position to give minimum air flow. Verify that the air volume at minimum air flow is not less than 95% of the exhaust air volume at maximum air flow. Hoods exceeding this fail the test and receive no rating.
 - c. Take a static pressure reading, using methods assuring an accurate reading, in an area of the ductwork no more than three feet nor less than one foot above the exhaust collar. Static pressure loss shall not exceed values given under Design Requirements in Part 1 of this Section.
 - d. Install ejector in test positions. For a typical bench-type hood, three positions are required: left, center and right as seen looking into the hood. In the left position the ejector center line is 12" from the left inside wall of the hood; center position is equal distance from the inside sidewalls; and the right position is 12" from the right inside wall. The ejector body is 6" in from the hood face in all positions. Location of ejector may require modification for hoods of unusual dimensions.
 - e. Install manikin positioned in front of the hood, centered on the ejector.
 - f. Fix detector probe in the region of the nose and mouth of the manikin. Take care that method of attachment of the probe does not interfere with the flow patterns around the manikin. Locate nose of manikin 9" in front of ejector (3" in front of sash).
 - g. Open tracer gas block valve. Correlate readings with a computer data acquisition package, which is capable of monitoring and visually recording a minimum of one reading per second for a minimal three minute time period at each of the three positions.
 - h. The control level rating of the hood shall be the maximum of the three average values for the three test positions.

- i. Record performance rating of the fume hood as XXAMyyy, where XX equals the release rate in liters per minute (4.0) and AM represents the as manufactured test sequence and yyy equals the control level in parts per million.
- j. All data on the above test conditions including instrumentation and equipment, test conditions, preliminary test and data information shall be provided on a one page report, including a printout of the average face velocities, and a separate graph-type performance curve on all three tracer gas positions.

10 Constant Volume/Bypass and VAV/Conventional Fume Hoods:

- a. Conduct test as outlined above with the sash open.
- b. Ignite a smoke bomb within the fume hood work area to verify that the fumes are quickly and efficiently carried away. Move the lighted bomb about the fume hood work area, checking near fume hood ends and work surface to verify that there is no reverse flow of air at these locations.

11 Air flow in fume hoods with auxiliary air:

- a. When the specified velocity has been determined, the volume of exhaust air should be verified by multiplying the average face velocity by the square foot area of the fume hood opening. The volume of exhaust air may be determined by other recognized procedures. In accordance with industry standards, the auxiliary air blower shall be turned off during face velocity grid readings.
- b. Following grid readings, turn on the auxiliary air blower, adjust to give the proper quantity of auxiliary air, and continue with other steps outlined in Test Procedures above. The quantity of auxiliary air should be determined by the use of a 20 point Pitot tube traverse of the duct and be correlated to an indicator to provide easy adjustment for varying volumes. The quantity of auxiliary air may be determined by other recognized procedures. The temperature of the auxiliary air shall be adjusted to 10 degrees F. above the room temperature.
- c. When the proper air volumes and temperatures have been obtained and with the sash in the full open position except as indicated, conduct the following tests:
 - i. Ignite a smoke bomb within the fume hood work area to verify that the fumes are quickly and efficiently carried away. Move the lighted bomb about the fume hood work area, checking near fume hood ends and work surface to verify that there is no reverse flow of air at these locations.
 - ii. Discharge smoke bomb into the auxiliary air duct ahead the blower to insure that the smoke is thoroughly mixed with the auxiliary air. Observe the flow of air down and into the fume hood face to verify that capture efficiency is 95% minimum.
- d. With the sash in a closed position, discharge a smoke bomb in auxiliary air duct and verify that all smoke and air is captured and drawn through the fume hood work area.

E1120 FIELD QUALITY CONTROL TESTING OF FUME HOODS

- 1 Field testing requirements:
 - a. Perform tests in field to verify proper operation of the fume hoods before they are put in use, using only qualified personnel.
 - b. Perform tests after installation is complete, the building ventilation system has been balanced, all connections have been made, and written verification has been submitted that the above conditions have been met.
 - c. Verify that the building make-up air system is in operation, the doors and windows are in normal operating position, and that all other hoods and exhaust devices are operating at designed conditions.
 - d. Correct any unsafe conditions disclosed by these tests before request of test procedures.
- 2 Testing equipment:
 - a. Properly calibrated hot wire thermal anemometer equal to Alnor Model No. 8500D-1 Compuflow.
 - b. Supply of 30-second smoke bombs.
 - c. Supply of titanium tetrachloride.
- 3 Test procedure - SEFA LF-1-1991:
 - a. Check room conditions in front of fume hood using a thermal anemometer and a smoke source to verify that the velocity of cross drafts does not exceed 20% of the specified average fume hood face velocity. Eliminate any cross drafts that exceed these values before proceeding.
 - i. CAUTION: Titanium tetrachloride fumes are toxic and corrosive. Use sparingly; avoid inhalation and exposure to body, clothing and equipment that might be affected by corrosive fumes.
 - ii. NOTE: No fume hood can operate properly if excessive cross drafts are present.
 - b. Perform the following test to verify conformance of actual fume hood face velocities to those specified. Turn on the exhaust blower with the sash in full open position. Determine the face velocity by averaging the velocity of six readings taken at the fume hood face: at the centers of a grid made up of three sections of equal area across the top half of the fume hood face and three sections of equal area across the bottom half of the fume hood face.
 - i. If not in accordance with specifications, refer to manufacturer's Troubleshooting Guide for aid in determining cause of variation in air flow.
 - ii. Check sash operation by moving sash through its full travel. Verify that sash operation is smooth and easy, and that vertical rising sash shall hold at any height without creeping up or down.

- 4 Field testing of air flow in fume hoods without auxiliary air:
 - a. Turn fume hood exhaust blower on. With sash in the open position check air flow into the fume hood using a cotton swab dipped in titanium tetrachloride or other smoke source. Verify that air flow is into the fume hood over the entire face area by a complete traverse of the fume hood 6" inside the face. Reverse flow is evidence of unsafe conditions. Take necessary corrective actions and retest.
 - b. Move a lighted smoke bomb throughout the fume hood work area directing smoke across the work surface and against the side walls and baffle. Verify that smoke is contained within the fume hood and rapidly exhausted.
- 5 Field testing of air flow in fume hoods with auxiliary air:
 - a. Calculate exhaust volume from face velocity data as determined above. Determine face velocity and exhaust volume with the auxiliary air blower off, in accordance with SEFA LF-1.
 - b. With sash in the open position check air flow into the fume hood using a cotton swab dipped in titanium tetrachloride or other smoke source. Verify that air flow is into the fume hood over the entire face area by a complete traverse of the fume hood 6" inside the face. Reverse flow is evidence of unsafe conditions. Take necessary corrective actions and retest.
 - c. Ignite smoke bomb at the source of auxiliary air and observe the flow of smoke/air down the face and into the hood. Close sash and observe flow patterns. Verify that operation is safe and proper.
 - d. Move a lighted smoke bomb throughout the fume hood work area directing smoke across the work surface and against the side walls and baffle. Verify that smoke is contained within the fume hood and rapidly exhausted.

ELEMENT F

SPECIAL CONSTRUCTION AND DEMOLITION

There is no special information in ELEMENT F. Refer to SECTION 12.0.

ELEMENT G

BUILDING SITEWORK

There is no special information in ELEMENT G. Refer to SECTION 12.0.

INTRODUCTION

Purpose

The University of Houston (UH) has a continuing need to modernize and upgrade its facilities to support future growth and operations. The resulting construction projects often have significant health and life safety requirements due to regulatory oversight. Since these requirements can impact the design of a project, Environmental Health and Life Safety (EHLS) prepared the EHLS Laboratory Design Guide to aid the campus community with planning and design issues. EHLS believes that the Guide, in conjunction with EHLS plan review and consultation, improves design efficiency and minimizes changes.

Application

Design professional shall design, and contractors shall construct facilities in accordance with Owner's requirements and the terms of the Contract Documents, of which this Campus Design Guidelines and Standards section 12.0 Addendum A.01 is a part.

Format of Guide

The Guide is formatted to address laboratory design issues pertinent to *General Laboratories* (e.g., chemical laboratories) in Section 1 with additional requirements for *Radioactive Materials Laboratories* and *Biosafety Level 2 Laboratories* presented in Sections 2 and 3 respectively.

Within the sections, specific design criteria are provided. Comments are included under the specific design criterion to give the user the rationale behind the design feature.

References

References include regulations (e.g., NFPA Fire Code), consensus standards (e.g., ANSI/ASHRAE/AAALAC), and good practices. Good practices stem from industry standards and/or the judgment/knowledge of UH EHLS professionals.

Design criteria are designated in the following ways:

Shall and Must: Mandated by applicable regulation(s).

- *The user of the Guide is required to include the design feature.*
- Based on well-established consensus standards/guidelines. "Must" is used to reflect a UH requirement, although not required by a regulation.

Should: Advisory in nature based on good engineering and safety practices.

- *It is left to the discretion of the user of the Guide to include the design feature.*

Limitations of the Guide

The EHLS Laboratory Design Guide is not all-inclusive. It does not cover all regulatory requirements nor does it cover all design situations. It is important to note that *use practices* and adjacent occupancy considerations must be considered during the design process, as they can directly influence how the

laboratory will be designed (e.g., how hazardous materials are used impacts how they are stored, which is a design issue) Adjacent occupancy will affect the strength of magnets proposed to be used and this has to be taken into design considerations. In all cases, EHLS should be consulted on questions regarding health, safety, fire and environment.

ACKNOWLEDGEMENT

The majority of this document was adapted from the NFPA Fire Code and ANSI Standards.

Section 1.1

VENTILATION

TABLE OF CONTENTS

		<u>Page</u>
A.	Regulations, Standards and References	1.1-3
B.	Scope	1.1-3
C.	General Ventilation Considerations	1.1-3
D.	Lab Pressurization	1.1-6
E.	Supply Air Arrangements	1.1-6
F.	Fume Hood Location	1.1-7
G.	Approved Equipment	1.1-8
H.	Fume Hood and Location Exhaust Ventilation Selection/Types	1.1-9
	1.0 General: Factors to Consider When Selecting a Fume Hood 2.0 Constant Volume Hoods 3.0 Variable Air Volume (VAV) Fume Hoods 4.0 Supply or Auxiliary Fume Hoods 5.0 Ductless Fume Hoods 6.0 Perchloric/Hot Acid Hoods 7.0 Radioactive Material Use 8.0 American with Disabilities Act (ADA) Hoods 9.0 Glove Boxes 10.0 Walk-in Fume Hoods 11.0 Special Purpose Hoods	
I.	Labeling	1.1-14

J.	Construction, Installation & Performance	1.1-14
K.	Power and Electrical	1.1-17
L.	Sashes	1.1-18
M.	Ducting	1.1-19
N.	Exhaust	1.1-20
O.	Wind Engineering	1.1-22
P.	Decibel Levels	1.1-23
Q.	Specialty, Controlled Climate, and Cold Rooms	1.1-23
R.	Lab Fume Hood Commissioning	1.1-23
S.	Animal Holding Rooms/Labs	
T.	Lab Tracking System Controls	
U.	Backdraft Dampening Fume Hoods	

A. Regulations, Standards and References

Regulations:

Code of Federal Regulation (CFR) 10, Parts 20 and 35

National Fire Protection Association (NFPA) 101/Life Safety Code (current edition)

National Fire Protection Association (NFPA) Handbook 45 (current edition)

Standard on Fire Protection for Laboratories Using Chemicals

National Fire Protection Association (NFPA) Handbook 99

Standard for Health Care Facilities

National Fire Protection Association (NFPA) 801 Facilities Handling Radioactive Material

Consensus Standards and References:

American National Standards Institute (ANSI), Z358.1

Emergency Eyewash and Shower Equipment

American National Standard for Laboratory Ventilation (ANSI/AIHA Z9.5)

American National Standard for Thermal Environmental Conditions for Human Occupancy (ANSI/ASHRAE 55-2013)

American Conference of Government Industrial Hygienists Threshold Limit Values for Chemical Substances and Physical Agents & Biological Exposure Indices (ACGIH)

ANSI Z136.1, American National Standard for Safe Use of Lasers

Texas Accessibility Standard

“Safe Handling of Radionuclides”, International Atomic Energy Agency, Safety Series No. 1, (1973 ed. Is still current as of 1999) (IAEA)

B. Scope

The requirements of this Guide apply to any UH System, Campus Energy Research Park, or component laboratory space in which hazardous materials are used, handled or stored.

C. General Ventilation Considerations

- 1. The lab should have mechanically generated supply air and exhaust air. All lab rooms shall use 100% outside air and exhaust to the outside. There shall be no recirculated air from the fume hood or laboratory space.**

Good Practice per UH EHLS
Prudent Practices in the Laboratory
NFPA 45, Chapter 6-4.1
ANSI/AIHA Z9.5, 4.10.3
ANSI/ASHRAE

- 2. Adjacent support offices may have recirculated air.**

3. **All newly constructed or renovated laboratory spaces must have a third party Associated Air Balance and Certification (AABC) certified air balance performed.**

The air balance of the lab must not be adjusted unless the department of Environmental Health and Life Safety (EHLS) has been notified of such changes.

4. **Mechanical climate control shall provide adequate temperature and humidity thresholds to meet Uniform Mechanical Controls and International Mechanical Controls as required.**

Uniform Mechanical Code

- **Per ASHRAE 55-1992, comfortable temperature range are defined as follows:**

Winter: 69-76 °F (at 35% RH); Summer: 73-79 °F (at 60% RH)

5. **Additional equipment loads must be considered in the overall CFM design of lab/support offices.**
6. **Labs shall not have open windows as this will change the air balance and create a lab directional airflow integrity deficiency.**
7. **Lab casework or other laboratory equipment must not impeded airflow throughout the lab. Air flow should be laminar and conducive to adequate air change rate.**

ASHRAE 55-1992

Many supply diffusers and room exhaust room openings are located along laboratory walls. Storage of boxes near these openings may obstruct the circulation of air and supply or exhaust air functioning.

8. **Normal expected Air Changes for laboratory facilities is set at the 6 ACH. This level will be modified on a case by case basis in collaboration with FPC, the design team and the EHSL team to address any specific high risk areas. Laboratories within animal holding rooms must meet AAALAC standards.**

National Research Council, Guide for the Care and Use of Laboratory Animals: Eighth Edition

Design and Construction of Inside Storage Rooms, General Industry Standard 29 CFR 1910. 106, OSHA 2206, Nov. 7, 1987 (OSHA, 1987).

ASHRAE Handbook, Chapter 13

International Mechanical Code

9. **Laboratories must be maintained under negative pressure in relation to the corridor or other less hazardous areas. Clean rooms requiring positive pressure should have entry vestibules provided with door-closing mechanisms so that both doors are not open at the same time. Consult with EHLS Fire Marshal for design details.**

ANSI/AIHA Z9.5 – 1992, 4.11.4-4.11.5

NFPA 45

As a general rule, directional airflow should be from areas of low hazard to a high hazard. Clean room or sterile room directional airflow shall be positive to the adjacent corridor or vestibules.

If there is a desire to modify to achieve sustainable initiatives or LEED certification those modifications must be approved by EHLS and the core team or the authority having jurisdiction.

10. **Where appropriate, general ventilation systems should be designed such that, in the event of an accident, they cannot be shut down.**

NFPA 45

11. **The transfer of duct work shall not be designed within laboratory spaces. All duct work shall be active, not passive in nature.**

NFPA 45

12. **The air velocity volume in each duct should be sufficient to prevent condensation or liquid or condensable solids on the walls of the ducts.**

NFPA 45

13. **Fume hoods should not be the sole means of room air exhaust. General room exhaust outlets shall be provided where necessary to maintain minimum air change rates and temperature control.**

ASHRAE 55-1992

14. **Operable windows shall be prohibited in new lab buildings and should not be used on modifications to existing buildings.**

Good Practice per UH EHLS

15. **Local exhaust ventilation – point of use exhaust devices (e.g., “snorkels” or “elephant trunks”), other than fume hoods, shall be designed to adequately control exposures to hazardous – materials (chemicals). An exhausted manifold or manifolds with connections to local exhaust may be provided as needed to collect potentially hazardous exhausts from gas chromatographs, vacuum pumps, excimer lasers, or other equipment which can produce**

potentially hazardous air pollutants. The containment source needs to be enclosed as much as possible, consistent with operational needs, to maximize control effectiveness and minimize air handling difficulties and costs.

ACGIH, Industrial Ventilation: A Manual of Recommended Practice, 23th edition, or latest edition

Enclosure minimizes the volume of airflow needed to attain any designed degree of containment control. This reduces fan size, motor horsepower, make up air volume, and make up air conditioning costs

16. **Fume hoods, exhaust fans, and electric starters shall be labeled to provide lab designation and which fan or ventilation system they are connected to**

Good Practice per UH EHLS
NFPA 45

17. **No laboratory ventilation system ductwork shall be internally insulated. Sounds baffle or external acoustical insulation at the source should be used for noise control but designed so as not to provide static pressure drop and create condensables.**

NFPA 45

18. **Duct work design shall provide adequate static pressure for both constant volume and/or manifolded systems**

D. Negative Pressurization

1. **Airflow shall be from low hazard to high hazard areas.**

Good Practice per UH EHLS
CDC-NIH Biosafety in Microbiological and Biomedical Laboratories

Anterooms may be necessary for certain applications, such as clean rooms or tissues culture rooms. Potentially harmful aerosols can escape from the containment of the laboratory room unless the room air pressure is negative to adjacent non-laboratory areas.

It is recommended that laboratories should contain a fully integrated laboratory control system to control the temperature, ventilation rate and room pressurization. The control system should constantly monitor the amount of supply and exhaust air for the laboratory rooms and regulate the flow to maintain a net negative pressurization.

2. **An adequate supply of make-up air (90% of exhaust) should be provided to the lab.**

Good Practice per UH EHLS

3. **An air lock or vestibule may be necessary in certain high-hazard laboratories to minimize the volume of supply air required for negative pressurization control. These doors should be provided with interlocks so that both doors cannot open at the same time.**

Good Practice per UH EHLS

4. **A corridor should not be used as a plenum.**
 - 4.1 **The above ceiling space within a laboratory must not be used as a plenum.**

NFPA 45

5. **Lab tracking DDC controlled (phoenix) exhaust valves shall fail open. Do not design airflow.**

E. Supply Air Arrangements

1. **Make-up air should be laminar in design and introduced at opposite end of the laboratory room from the fume hood(s) and flow paths for room HVAC systems shall be kept away from hood locations, to the extent practical. Supply registers shall not be bidirectional but laminar in order not to produce cross drafting.**

NFPA 99, Chapter 5-4.3.2

NFPA 45, Chapter 6-3.4 and 6-9.1

NIH Design Policy and Guidelines, Research Laboratory, 1996, D.7.7

ANSI Z9.5-2012

Air turbulence defeats the capacity of hoods to contain and exhaust contaminated air.

2. **Make-up air shall be introduced in such a way that negative pressurization is maintained in all laboratory spaces and does not create a disruptive air pattern (laminar flow.)**

NFPA 45

3. **Cabinetry or other structures or equipment should not block or reduce effectiveness of supply or exhaust air.**

Good Practice per UH EHLS

4. **Supply system air should meet the technical requirements of the laboratory work and the requirements of the latest version of ASHRAE, Standard 62, Ventilation for Acceptable Indoor Air Quality.**

Good Practice per UH EHLS

ASHRAE Standard 62

Uniform Mechanical Code

F. Fume Hood Location

- 1. Fume hoods should be located away from activities or facilities, which produce air currents or turbulence. Locate away from high traffic areas, air supply diffusers, doors.**

NFPA 99, Chapter 5-4.3.2
NFPA 45, Chapter 6-3.4 and 6-9.1

Air turbulence affects the capability of hoods to exhaust contaminated air. Eddies are created by people passing by and by other sources of air currents.

- 2. Fume hoods should not be located adjacent to a single means of egress. Recommend that hoods be located more than 10 feet from any door or doorway.**

NFPA 45, Chapter 6-9.2
NFPA 45, Chapter 3-4.1(d)
NFPA 99, Chapter 5-4.3.2
ANSI/AIHA Z9.5, 5.4

A fire hazard or chemical release incident, both of which may start in a fume hood, can block an exit rendering it impassable. A fire or explosion in a fume hood located adjacent to a path of egress could trap someone in the lab.

- 3. Fume hood openings should not be located opposite workstations where personnel will spend much of their working day, such as desks or microscope benches.**

NFPA 45, Chapter 6-9.3

Materials splattered or forced out of a hood could injure a person seated across from the hood.

- 4. An emergency eyewash/shower station shall be within 10 seconds or 55 feet travel distance away of each work area.**

ANSI Z358.1

Per ANSI Z358.1, the requirement for an eyewash/shower is triggered when an employee may be exposed to substances, which are “corrosive or severely irritating to the skin or which are toxic by skin absorption” during normal operations or foreseeable emergencies. Fume hoods are assumed to contain such substances; hence UH interprets this regulation to mean that emergency eyewash/shower station shall be within 10 seconds or 55 feet travel distance away from work areas.

- 5. An ADA emergency eyewash/shower shall be within 10 seconds or 55 feet travel distance away from an ADA work area (minimally one ADA hood per laboratory floor).**

Texas Accessibility Standard (TAS)
Disabled Accessibility Guidebook
ANSI

The location of at least ADA hood per floor enable disabled individuals to conduct their research without having to transport chemicals, etc., in elevators.

If a disabled researcher works in a laboratory, then all parts of the laboratory and its emergency equipment must be designed or adapted to meet the user's needs

G. Approved Equipment

- 1. All fume hoods shall meet the requirements of NFPA 45, Standard on Fire Protection for Laboratories Using Chemicals. EHLS must approve the use of low flow hoods or low flow concept hoods.**

H. Fume Hood and Local Exhaust Ventilation Selection/Types

- 1. General: Factors to consider when selecting a fume hood:**

- a. Room size (length x width x height)
- b. Number of rooms air changes
- c. Lab heat load
- d. Types of material used
- e. Linear feet of hood needed based on:
 - ✓ Number of users/hood
 - ✓ Frequency of use
 - ✓ % of time working at hood
 - ✓ Size of apparatus to be used in hood, etc.

A facility designed for intensive chemical use should have at least 2.5 linear feet of hood space per occupant.

Good Practice per UH EHLS

Evaluating the operational and research needs of the users will ensure that the appropriate type and number of hoods is integrated into the laboratory.

- 2. Constant Volume Hoods**

These hoods permit a stable air balance between the ventilation systems and exhaust by incorporating a bypass feature. If bypass is 100%, this allows a constant volume of air to be exhausted through the hood regardless of sash position.

3. Variable Air Volume (VAV) Fume Hoods

These hoods maintain constant face velocities by varying exhaust volumes in response to changes in sash position. Because the only amount of air needed to maintain the specified face velocity is pulled from the room, significant energy savings are possible when the sash is closed. However, since these hoods cost more upfront and require more maintenance, effective sash management (e.g., pull sash closed when not using hood) is necessary.

Good Practice per UH EHLS

4. Supply or Auxiliary Air Hoods

These hoods are not permitted unless an exception is granted by EHLS.

It is very difficult to keep the air supply and exhaust of supply hoods properly balanced. In addition the supply air is imtemperate causing discomfort for those working in the hot or cold air stream. As a result, the supply vent is often either shut or blocked off, which eliminates any potential benefit of this type of hood. Finally, the presence and movement of the user's body in the stream of supply air creates turbulence that degrades the performance of the hood.

5. Ductless Fume Hoods: Portable non-ducted fume hoods are generally not permitted, however, a portable hood may be used for limited applications (e.g., used inside of an existing hood for a special application, such as odor control). Such applications must be reviewed and approved EHLS on a case-by-case basis.

ANSI/AIHA Z9.5, 5.16

Portable hoods often do not meet the regulatory airflow requirements. Filters used with these units must be changed frequently and vary in filtration effectiveness from chemical to chemical.

6. Perchloric/Hot Acid Hoods:

- a. Heated Perchloric acid shall only be used in a laboratory hood specifically designed for its use and identified as "For Perchloric Acid Operations." (Exception: Hoods not specifically designed for use with Perchloric acid shall be permitted to be used where the vapors are trapped and scrubbed before they are released into the hood).

NFPA 45, Chapter 6-11.1

Heated Perchloric acid will give off vapors that can condense and form explosive perchlorates. Limited quantities of Perchloric acid vapor can be kept from

condensing in laboratory exhaust systems by trapping and scrubbing the vapors at the point of origin.

- b. Perchloric acid hoods and exhaust ductwork shall be constructed of materials that are acid resistant, nonreactive, and impervious to Perchloric acid.

NFPA 45, Chapter 6-11.2
ANSI/AIHA Z9.5

- c. The exhaust fan should be acid resistant and spark-resistant. The exhaust fan motor should not be located within the ductwork. Drive belts should not be located within the ductwork.

NFPA 45, Chapter 6-11.3

- d. Ductwork for Perchloric acid hoods and exhaust systems shall take the shortest and straightest path to the outside of the building and shall not be manifolded with other exhaust systems. Horizontal runs shall be as short as possible, with no sharp turns or bends. The ductwork shall provide a positive drainage slope back into the hood. Duct shall consist of sealed sections. Flexible connectors shall not be used.

NFPA 45, Chapter 6-11.4

- e. Sealants, gaskets, and lubricants used with Perchloric acid hoods, duct work, and exhaust systems shall be acid resistant and nonreactive with Perchloric acid.

NFPA 45, Chapter 6-11.5
ANSI/AIHA Z9.5

- f. A water spray system shall be provided for washing down the hood interior behind the baffle and the entire exhaust system. The hood work surface shall be watertight with a minimum depression of 13 mm (½ inch) at the front and sides. An integral trough shall be provided at the rear of the hood to collect wash-down water.

NFPA 45, Chapter 6-11.6
ANSI/AIHA Z9.5

Perchloric acid is a widely used reagent known to produce flammable or explosive reaction products; hence, the need to have wash down capabilities after each use to remove residues. A watertight surface will contain any chemical spills or leaks from leaking to underneath hood.

- g. Spray wash-down nozzles shall be installed in the ducts no more than 5 ft. apart. The ductwork shall provide a positive drainage slope back into the hood. Ductwork shall consist of sealed sections and no flexible connectors shall be used.

NFPA 45, Chapter 6-11.4

- h. The hood surface should have an all-welded construction and have accessible rounded corners for cleaning ease.

NFPA 45

Access for cleaning is an important design feature

- i. The hood baffle shall be removable for inspection and cleaning.

NFPA 45, Chapter 6-11.7

- j. Each Perchloric acid hood must have an individually designated duct and exhaust system.

ANSI/AIHA Z9.5

7. Radioactive Material Use

- a. Laboratory hoods in which radioactive materials are handled shall be identified with the radiation hazard symbol.

NFPA, Chapter A-6-12.1

- b. Fume hoods intended for use with radioactive isotopes must be constructed of stainless steel or other materials that will not be corroded by the chemicals used in the hood.

NCRP Report #8

NFPA 99, Chapter 5-4.3.3

- c. The interior of all radioisotope hoods must have covered corners to facilitate decontamination.

NFPA 99, Chapter 5-4.3.3

IAEA, Safe Handling of Radionuclides

Cracks and crevices are difficult to decontaminate.

- d. The hood exhaust may require filtration by HEPA or Charcoal HEPA filters. Where such is the likelihood, the hood must have a bag-out plenum for mounting such filters and fan capacity for proper operation of the hood with the filter installed. The most appropriate location for the plenum is near the exhaust port of the fume hood (i.e., proximal to the hood).

NFPA 99, Chapter 5-4.3.3

IAEA, Safe Handling of Radionuclides

- e. Hoods used for radioactivity should have sashes with horizontal sliding glass panels mounted in a vertical sash.

NFPA 99, Chapter 5-4.3.3
10 CFR 20: Appendix B
IAEA, Safe Handling of Radionuclides

- f. The cabinet on which the hood is installed shall be adequate to support shielding for the radioactive materials to be used therein.

NFPA 99, Chapter 5-4.3.3
10 CFR 20: Appendix B
IAEA, Safe Handling of Radionuclides

- g. In general, glove boxes with HEPA filtered exhausts shall be provided for operations involving unsealed radioactive material that emit alpha particles. Consults with the Radiation Safety Program for specific requirements.

NFPA 99, Chapter 5-4.3.3
10 CFR 20: Appendix B
IAEA, Safe Handling of Radionuclides

8. American with Disabilities Act (ADA) Hoods: Must consult with UH's ADA Compliance Office regarding the number of lab hoods to install in facilities which are accessible to and usable by individuals with disabilities – recommend minimally one ADA hood per laboratory floor. These hoods must provide appropriate work surface heights, knee clearances, reach to controls, etc., to individuals in wheelchairs.

Texas Accessibility Standard (TAS)
Disability Accessibility Guidebook

The location of at least one ADA hood per floor will enable disabled individuals to conduct their research without having to transport chemicals, etc., in elevators.

9. Walk-in Fume Hoods; these hoods must meet the type, design, and construction requirements of ANSI/AIHA Z9.5-1992, 5.13.

ANSI/AIHA Z9.5

10. Special Purpose Hoods: These hoods include enclosures for operations for which other types of hoods are not suitable (e.g., enclosures for analytical balances, histology processing machines, special mixing stations, evaporation racks). These hoods must be designed per ANSI Z9.2 and the Industrial Ventilation manual.

ANSI/AIHA Z9.5
Industrial Ventilation – A Manual of Recommended Practice
(ACGIH)

I. Fume Hood Labeling

1. Laboratory hoods and special local exhaust ventilation systems (SLEV) shall be labeled to indicate intended use (e.g., "Perchloric Acid Hood").

NFPA 45, Chapter 6-12.1

2. A label must be affixed to each hood containing the following information from the last inspection:
 - a. Verification due date
 - b. Average face velocity
 - c. Inspector's initials

NFPA 45, Chapter 6-12.2 (NOTE: This code cites slightly different information for the label. UH determined it was appropriate to create a label with the above information).

J. Fume Hood Construction, Installation & Performance

1. Fume hoods designed for use must meet the intent of the chemicals to be used. Hoods that will exhaust corrosive materials, acids, etc. shall be designed for the intended use.
2. New hoods can be mounted above a chemical storage cabinet, provided that the cabinet meets the NFPA 101 Life Safety Code requirements for construction.

Good Practice per UH EHLS

Recommend that solvent storage not be located under the laboratory fume hood as this location is where fires are most likely to occur in laboratories.

3. Type 316 stainless steel should be used for all parts of the fume hood system ventilation duct as long as compatibility is maintained.

Good Practice per UH EHLS

This material affords good, general corrosion, impact and vibration resistance.

4. Fume hood interior surfaces shall be constructed of corrosion resistant, non-porous, non-combustible materials such as type 316 stainless steel, and should be smooth and impermeable with rounded corners. These materials shall have a flame spread index of 25 or less when tested in accordance with NFPA method 255, Standard Method of Test of Surface Burning Characteristics of Building Materials.

NFPA 45, Chapter 6-8.1.1, 6-11.2, 6-11.6

NFPA 99, 5-4.3.3

ANSI/AIHA Z9-5-1992, 5.12

Type 316 stainless steel (SS 316) is specified to avoid corrosion, thereby extending fume hood life. Splashes of liquid containing radioactive materials can be easily cleaned when hoods are constructed of non-porous materials such as stainless steel. Perchloric acid digestion over time may result in the condensation and consequential

formation of perchlorate crystals which, in large quantities, pose an explosion hazard, especially if combined with organic chemical condensate.

5. Hood inserts are only permitted for radioactive iodination procedures specifically approved by the UH Radiation Safety Officer.
6. Laboratory hoods shall be provided with a means of containing minor spills.

NFPA 45, Chapter 6-9.1.3
ANSI/AIHA Z9.5, 5.2

The means of containing minor spills might consist of a 6.4-mm (¼ in.) recess in the work surface, use of pans or trays, or creation of a recess by installing a curb across the front of the hood and sealing the joints between the work surface and the sides, back, and curb of the hood.

7. There must be a horizontal bottom airfoil inlet at the front of the hood.

ANSI/AIHA Z9.5, 5.2

The air foil at the front of the hood floor assures a good sweep of air across the working surface toward the back of the hood. This minimizes the generation of turbulent or eddy currents at the entrance to the hood.

8. Adjustable baffles with horizontal slots must be present in the fume hood interior at the back and top when using chemicals, solvents, etc. that are heavier than air.

ANSI/AIHA Z9.5, 5.2

Locating the slots in this manner will attain reasonably uniform face velocity under different conditions of hood use as related to heat sources, size, and configuration of equipment in the hood.

9. Before a new fume hood is put into operation, an adequate supply of makeup air must be provided to the lab.

Good Practice per UH EHLS

A fume hood exhausts a substantial amount of air. For this reason, additional make up air must be brought into the room to maintain a proper air balance.

10. Face Velocity:

Radioisotope Laboratory fume hoods shall provide a minimum average effective face velocity of 120 linear feet per minute (fpm), with a minimum of 80 fpm at any point.

11. Certification: Laboratory fume hoods, when installed in a new or renovated laboratory space, must pass an **ASHRAE 110-2013 test** performed after installation within the laboratory space.

12. Where the required velocity can be obtained by partly closing the sash, the sash and/or jamb shall be marked to show the maximum opening at which the hood face velocity will meet the requirements. Fume hood sashes shall be set at a minimum of 14" working heights and designed for an 18" working height.

Good Practice per UH EHLS

13. An airflow indicator shall be provided and located so that it is visible from the front of the fume hood.

NFPA 45, Chapter 6-8.7.1
ANSI/AIHA Z9.5-1992, 5.8

Follow manufacturer's procedures for calibration of air flow indicator during installation. Follow manufacturer's schedule for periodic calibration and maintenance parameters thereafter. Performance criteria for various airflow indicators are as follows:

- Kim Wipes: Shows inward flow
- Magnahelic Gauges: Mark on gauge inches water read when average face velocity at 120 fpm
- FPM Readout: Average readout is 120 fpm
- Audio/Visual Alarms: Go into alarm mode if average face velocity drops to 80 fpm

14. Baffles shall be constructed so that they may not be adjusted to restrict the volume of air exhausted through the laboratory hood.

NFPA 45, Chapter 6-8,1-2

15. Fans should run continuously without local control from hood location and independently of any time clocks or switches.

NFPA 45

16. For new installations or modifications of existing installations, controls for laboratory hood services (e.g., gas, air, and water) should be located external to the hood and within easy reach.

NFPA 45, Chapter 6-8.5.1

17. Shutoff valves for services, including gas, air, vacuum, and electricity shall be outside of the hood enclosure in a location where they will be readily accessible in the event of fire in the hood. The location of such a shut-off shall be legibly lettered in a related location on the exterior of the hood.

NFPA 99, Chapter 5-4, 3.6

NFPA 45

18. Laboratory hoods shall not have an on/off switch located in the laboratory. Exhaust fans shall run continuously without direct local control from laboratories.

NFPA 45

19. Drying ovens shall not be placed under fume hoods.

Good Practice per UH EHLS

20. High limit switches shall not be installed in duct work or fume hoods.

Good Practice per UH EHLS

K. Fume Hood Power and Electrical

1. Chemical fume hood exhaust fans shall be connected to an emergency power system in the event of a power failure.

Good Practice per UH EHLS

This backup power source will ensure that chemicals continue to be exhausted.

2. Emergency power circuits should be available for fan service so that fans will automatically restart upon restoration after a power outage.

Good Practice per UH EHLS

Continual fan service will ensure that hazardous materials are exhausted continually.

3. **Momentary or extended losses of power shall not change or affect any of the control system's set points, calibration settings, or emergency status. After power returns, the system shall continue operation exactly as before, without the need for any manual intervention. Alarms shall require manual reset, should they indicate a potentially hazardous condition.**

4. Fume hood ventilating controls should be arranged so that shutting off the ventilation of one fume hood will not reduce the exhaust capacity or create an imbalance between exhaust and supply for any other hood connected to the same system.

NFPA 99, Chapter 5-4.3.4

5. **In installations where services and controls are within the hood, additional electrical disconnects of one fume hood will not reduce the exhaust capacity or create an imbalance between exhaust and supply for any other hood connected to the same system.**

NFPA 45, Chapter 6-8.4.1

Locating services, controls, and electrical fixtures external to the hood minimizes the potential hazards of corrosion and arcing.

6. Hood lighting shall be provided by UL-listed fixtures external to the hood or, if located within the hood interior, the fixtures shall meet the requirements of NFPA 70, (National Electrical Code).

NFPA 45, Chapter 3-6

7. Light fixtures should be of the fluorescent type and replaceable from outside the hood. Light fixtures must be displaced or covered by a transparent impact resistant vapor tight shield to prevent vapor contact.

Good Practice per UH EHLS

Fluorescent bulbs radiate less heat than conventional bulbs while maintaining a safe and illuminated work area inside the hood.

8. The valves, electrical outlets and switches for utilities serving hoods should be placed at readily accessible locations outside the hood. All shutoff valves should be clearly labeled. Plumbing (e.g., vacuum lines) should exit the sides of the fume hood and not the bench top.

NFPA 45, Chapter 6-8.5.1
NFPA Chapter 5-4.3.6 (Health Care)

9. Approximately half of the 120 V outlets in common instrument rooms are to be on emergency power.

VA Lab requirement

L. Sashes

1. Hoods shall have transparent movable sashes constructed of shatter-resistance, flame resistant material and capable of closing the entire front face.

ANSI/AIHA Z9.5-2012
Good Practice per UH EHLS

2. Vertical-rising sashes are preferred. If horizontal sashes are used, sash panels (horizontal sliding (and must be 12 to 14 inches in width.

Good Practices per UH EHLS

Sashes may offer extra protection to lab workers since they can be positioned to act as a shield.

3. A force of five pounds shall be sufficient to move vertically and/or horizontally moving doors and sashes.

ANSI/AIHA Z9.5-2003, 3.1.1.

M. Ducting

1. Hood exhausts should not be manifolded together:
 - Exhaust ducts from each lab unit shall be separately ducted to a point outside the building, to a mechanical room, or to a shaft.
 - Connection to common chemical fume hood exhaust duct system shall be permitted to occur within a building only in any of the following locations-
 - i. A protected mechanical room
 - ii. Fire rated shaft
 - iii. A point outside the building

NFPA 45

Replacement of duct with same size and same size fan will trigger an automatic ASHRAE test for a fume hood. However EHLS may request one on a case by case basis.

2. Horizontal ducts must slope at least 1 inch per 10 feet downward in direction of airflow to a suitable drain or sump.

ANSI/AIHA Z9.5 [verify version]

Liquid pools and residue buildup which can result from condensation may create a hazardous condition if allowed to collect.

3. Ducts exhausting air from fume hoods should be constructed entirely of non-combustible material. Gaskets should be resistant to degradation by the chemicals involved and fire resistant.

NFPA 45, Chapter 6-5.1

4. Automatic fire dampers shall not be used in laboratory hood exhaust systems. Fire detection and alarm systems shall not be interlocked to automatically shut down laboratory hood exhaust fans.

NFPA 45, Chapter 6-10

Fire dampers are not allowed in hood exhaust ducts. Normal or accidental closing of a damper may cause an explosion or impede the exhausting of toxic, flammable, or combustible materials in the event of a fire.

5. Ducts must be made of a compatible material that co-exists with the type of chemical being exhausted.

6. All exhaust ducts must be tested as medium pressure duct @ 3" lwc. and test to not allow for more than 1% loss per 100 feet of duct.

N. Exhaust

1. New exhaust fans should be oriented in an up-blast orientation.

Good Practice per UH EHLS

Any other type of fan orientation increases the fan workload and increases the risk of exhaust emission re-entrainment.

2. Hood exhaust stacks shall extend at least 7 feet above the roof. Discharge shall be directed vertically upward.

Good Practice per UH EHLS

If parapet walls are present, EHLS recommends that stacks extend at least 2 feet above the top of a parapet wall or at least 7 feet above the roof, whichever is greater.

NOTE: The UH Facilities Planning and Construction office must be contacted if any building feature such as exhaust stacks, extend above the roofline.

3. Hood exhausts shall be located on the roof as far away from air intakes as possible to preclude recirculation of laboratory hood emissions within a building. For toxic gas applications, the separation distance shall be at least 75 feet from any intake.

Good Practice per UH EHLS

As future gas necessities are difficult to predict, EHLS recommends at least 75 feet for all applications.

4. **Discharge from exhaust stacks must have a velocity of at least 3,000 fpm. Achieving this velocity should not be done by the installation of a cone type reducer. The duct may be reduced, but the duct beyond the reduction should be of sufficient length to allow the air movement to return to a linear pattern.**

ANSI Z.95-2012

Good Practice per UH EHLS

Strobic type exhaust fans may be used to address exhaust velocity needs.

5. Rain caps that divert the exhaust toward the roof are prohibited.
6. Laboratory ventilation exhaust fans shall be spark-proof and constructed of materials or coated with corrosion resistant materials for the chemicals being transported. V-belt drives shall be conductive.

NFPA 45

7. Vibration isolators shall be used to mount fans. Flexible connection sections to ductwork, such as neoprene coated glass fiber cloth shall be used between the fan and its intake duct when such material is compatible with hood chemical use factors.
8. **Each exhaust fan assembly shall be individually matched (cfm, static pressure, brake horsepower, etc.) to each laboratory ventilation system.**

Industrial Ventilation Manual

9. Exhaust fans shall be located outside the building at the point of final discharge. Each fan shall be the last element of the system so that the ductwork through the building is under negative pressure.
10. Fans shall be installed so they are readily accessible for maintenance and inspection without entering the plenum. If exhaust fans are located inside a penthouse, PPE needs for maintenance workers shall be considered.

NFPA 45

O. **Wind Engineering**

1. Wind engineering evaluations should be conducted for all wind directions striking all walls of a building where fume hood exhaust is likely to have significant ground level impact, or is likely to affect air intake for the same nearby buildings.

Good Practice per UH EHLS

2. Emergency generator exhaust should be considered in the wind engineering study.

Good Practices per UH EHLS

P. **Noise**

1. System design must provide for control of exhaust system noise (combination of fan-generated noise and air-generated noise) in the laboratory. Systems must be designed to achieve an acceptable Sound Pressure Level (SPL) frequency spectrum (room criterion) as described in the 2011 *HVAC Applications Handbook*
ANSI/AIHA Z9.5, 10
2011 HVAC Applications Handbook

Acceptable SPL may vary depending on the intended room use. UH has established a NC of 40 for a standard laboratory.

Q. **Specialty, Controlled Climate, and Cold Rooms**

1. The issue of ventilation in cold rooms during periods of occupancy or for storage of hazardous materials must be addressed. EHLS should be consulted to review

arrangements for providing fresh and exhaust air during periods of occupancy and for storage of hazardous materials or compressed gases.

Good Practice per UH EHLS

Cold Rooms used only for the storage of non-hazardous materials must have latches that can be operated from the inside to allow for escape.

2. Specialty rooms, designed for human occupancy must have latches that can be operated from the inside to allow for escape.

Good Practice per UH EHLS
NFPA 101 Life Safety Code

3. Latches and frames shall be designed to allow actuation under all design conditions, such as freezing. Magnetic latches are recommended.

Good Practice per UH EHLS

4. Doors of walk-in specialty rooms must have viewing windows and external light switches.

Good Practice per UH EHLS

R. **Lab Hood Commissions**

1. Proper operation of fume hoods must be demonstrated by the contractor installing the fume hood prior to project closeout. Containment performance test per ANSI/ASHRAE 110 is required by EHLS.

ANSI/AIHA Z9-5-2012

Section 1.2

EMERGENCY EYEWASH AND SAFETY SHOWER EQUIPMENT

TABLE OF CONTENTS

		<u>Page</u>
A.	Regulations, Standards and References	1.2.2
B.	Scope	1.2-2
C.	Applications	1.2-3
D.	General Location	1.2-3
E.	Eyewash Requirements	1.2-5
F.	Deluge Shower Requirements	1.2-5
G.	Testing	1.2-7
H.	Approved Equipment	1.2-7

A. Regulations, Standards and References

Regulations:

ANSIZ 358

Standards and References:

American National Standards Institute (**ANSI, Z358.1**)
Emergency Eyewash and Shower Equipment

National Fire Protection Association
Health Care Facilities, Handbook 99, Chapter 10-6, Emergency Shower

Texas Accessibility Standard (TAS)

B. Scope

This Guide presents the minimum performance requirements for eyewash and shower equipment for the emergency treatment of the eyes or body of a person exposed to injurious materials. It covers the following types of equipment emergency shows, eyewash equipment, and combination shower or eye/face wash.

1. A plumbed eyewash shall be provided for all work areas where, during normal operations or foreseeable emergencies, the eyes of an employee may come into contact with a substance, which can cause corrosion, severe irritation, or is toxic, by skin absorption. Drench hoses, sink faucets, or showers are not acceptable eyewash facilities.

NFPA 99 Chapter 10-6

2. An emergency shower shall be provided for all work areas where, during normal operations or foreseeable emergencies, area of the body may come into contact with a substance which is corrosive, severely irritating to the skin or is toxic by skin absorption.

NFPA 99 Chapter 10-6

A deluge shower shall be installed within all acid washing areas.

C. Applications

Where the eyes or body of any person may be exposed to injurious or corrosive materials, suitable facilities for quick drenching or flushing of the eyes and body shall be provided within the work area for immediate emergency use. These situations include:

- Areas where corrosive or injurious chemicals are used, such as:
 - Solutions of inorganic or organic acids or bases with a pH of 2.0 or less, or 12.5 or more,
 - Other organic or inorganic materials that are corrosive or irritating to eyes or skin (e.g., methylene chloride, phenol, or)
 - Organic or inorganic materials that are significantly toxic by skin absorption (e.g., phenol),
- Areas where corrosive chemicals are used in a closed system that can catastrophically fail and cause the chemicals to leak (i.e., liquid lead-acid battery charging areas, or areas where pressurized systems with corrosive liquids are used).
- Storage areas where breakable containers of injurious or corrosive materials are handled outside their original shipping cartons.
- Waste accumulation areas that could contain corrosive waste materials.

- All work areas where formaldehyde solutions in concentrations greater than or equal to 0.1% are handled, and
- Areas where operations involve the use of air or water reactive liquids or solids.

29 CFR 1910.151

D. General Location

Where to Install

1. Emergency eyewash facilities and deluge showers shall be unobstructed and accessible locations that require no more than 10 seconds or 55 feet travel distance away from the injured person to reach along an unobstructed pathway (i.e., no doors without panic bars or which don't swing open when pushed). If both eyewash and shower are needed, they shall be located so that both can be used at the same time by one person.

ANSI Z358.1, 4.6.1 and 5.4.4

2. Americans with Disabilities Act (ADA) Emergency Eyewash/Showers: Install an emergency eyewash/shower so that a disabled person can access it within 10 seconds or 55 feet travel distance. These emergency eyewash/showers must provide appropriate accessibility (e.g., activation of controls and height of eyecups) to individuals in wheelchairs.

Signage

3. Emergency eyewash and shower locations shall be identified with a highly visible sign. The areas around the eyewash or shower shall be well lit and highly visible.

ANSI Z358.1

4. Whenever possible, the floor immediately beneath the eyewash and emergency shower, and to a radius of between about 12-30 inches, shall be a distinctive pattern and color to facilitate promoting a clear path of access and clearly identify the location.

Good Practice per UH EHLS

Prohibitions around Equipment

5. No obstructions, protrusions, or sharp objects shall be located within 16 inches from the center of the spray pattern of the emergency shower facility.

ANSI Z358.1

6. Electrical apparatus, telephones, thermostats, or power outlets should not be located within 6 feet of either side of the emergency shower or emergency eyewash facility (i.e., a 6-foot clearance zone) or have electrical equipment GFCI protected.

Good Practice per UH EHLS
N.F.P.A. 101 Life Safety Code

Prevent potential electrical hazards posed when the water generated by the activated emergency eyewash/safety shower is in proximity to live electrical equipment.

E. Eyewash Requirements

Flushing Rates

- 1. A means shall be provided to ensure that a controlled flow of flushing fluid is provided to both eyes simultaneously.**

ANSI Z358.1, 5.1.1

- 2. Eyewash equipment shall be capable of delivering to the eyes not less than 0.4 gallons per minute of flushing fluid for 15 minutes.**

ANSI Z358

Flushing Temperature

- 1. Any eye wash or eye wash combinations must incorporate an adjustable tepid watering valve for hot and cold to maintain a 60-90 degree temperature range.**

All independent eye wash units

ANSI Z358.1, 5.1.1

Eyewash Positioning

- 2. The eyewash unit shall be positioned with the water nozzles 33-45 inches from the floor and 6 inches minimum from the wall or nearest obstruction. The unit must be located at an operable sink.**

ANSI Z358.1, 5.4.1

Equipment Activation

- 3. The valve shall be designed so that the flushing fluid remains on without requiring the use of the operator's hands. The valve shall be designed to remain activated until intentionally shut off.**

ANSI Z358.1.5.2 (a)

ANSI Z358.1.5.1.5

Eyewash Equipment Protection

- 4. Nozzles shall be protected from airborne containments. The removal of the nozzle protection shall not require a separate motion by the operator when activating the unit.**

ANSI Z358.1, 5.1.3

F. Deluge Shower Requirements

- 1. The emergency shower location must have a level surface beneath the shower head.**

Good Practice per UH EHLS
NFPA 101 Life Safety Code

Having a level surface will prevent the users from tripping while trying to access and use the emergency shower.

- 2. Emergency showerheads shall be designed so that a flushing fluid column is provided that is not less than 82 inches and not more than 96 inches in height from the surface on which the user stands.**

ANSI Z358.1.4.1

- 3. The shower head should not be mounted flush or recessed within any constructed surfaces or partitions and the center of the spray pattern shall be located at least 16 inches from any obstruction.**

Good Practice per UH EHLS
ANSI Z358.1, 4.1

Recessing the showerhead may limit access and/or affect spray pattern.

- 4. The spray pattern shall have a minimum diameter of 20 inches at least 60 inches above the surface on which the user stands.**

ANSI Z358.1, 4.1

Flushing Rates

- 5. Emergency showerheads shall be capable of delivering a minimum 75.7 liters per minute (20 gpm) of flushing fluid.**

ANSI Z358.1, 4.1

- 6. The shower should be attached to a flushing fluid supply from a 1-inch minimum iron pipe size (IPS).**

Good Practice (based on ANSI manufacturer's test procedures)

Equipment Activation

- 7. The valve shall be designed so that the flushing fluid remains on without requiring the use of the operator's hands. The valve shall be designed to remain activated until intentionally shut off.**

ANSI Z358.1, 4.2

- 8. The manual actuator, triangle pull, shall be located not more than 69 inches above the surface on which the user stands. The manual actuator shall be free from obstruction for 18 to 24 inches in all directions. The actuator shall not be mounted flush or recessed within any constructed surfaces or partitions.**

ANSI Z358.1, 4.3

Design for Maintenance/Use

- 9. The water supply to showers and/or shower/eyewash combination units should be controlled by a ball-type shutoff valve, which is visible and accessible to shower testing personnel in the event of leaking or failed shower head valves.**

Good Practice per UH EHLS

This design will make maintenance easier.

- 10. A water flow device must be attached to the shower that activates the fire alarm system using a Priority 2 when water is flowing.**
- 11. The water that is discharged through the shower or eyewash must be tepid. Any eye wash or eye wash combinations must incorporate an adjustable tepid watering valve for hot and cold to maintain a 60-90 degree Fahrenheit temperature range.**

G. Testing

- 1. The contractor installing the emergency eyewash or shower equipment prior to project closeout and facility occupation must demonstrate proper operation of the equipment. Tags to allow monthly testing records to be kept shall be affixed to the showers and eyewash fountains.**

Good Practice per UH EHLS

By testing the equipment, UH can be assured that it is working properly before the users begin their research.

H. Approved Equipment

- 1. All emergency showers and eyewash facilities shall meet the requirements of ANSI Z358.1 and shall be installed in accordance with ANSI Z358.1.**

Section 1.3

**PRESSURE VESSEL COMPONENTS AND SYSTEMS
AND COMPRESSED GAS CYLINDERS**

TABLE OF CONTENTS

		<u>Page</u>
A.	Regulations, Standards and References	1.3.2
B.	Scope	1.3-2
C.	Design Features for the Storage of Compressed Gas Cylinders – General	1.3-3
D.	Design Features for the Storage of Compressed Gas Cylinders – Toxic and Highly Toxic Gases	1.3-4
E.	Design Features for the Storage of Compressed Gas Cylinders – Medical Gases	1.3-7
F.	Design of Systems and Apparatus for Cryogenic Fluids	1.3-8
G.	Design of Pressure Vessels and Systems	1.3-9

1. Regulation, Standards and References

NFPA 45, Chapter 8
 NFPA 99, Chapter 4
 NFPA 704, Chapter 2
 UH Lab Safety Policies and Procedures
 NFPA 55

2. Scope

The Guide applies to all UH facilities including leased properties. It covers all unfired pressure vessels (i.e., storage tanks, compressed gas cylinders) that have been designed to

operate at pressure above 15 psig., including the storage and use of compressed gas cylinders and cryogenic fluids.

Note that there are numerous regulations governing the proper use of compressed gas cylinders; use is not addressed by the Guide, as it is a work practice issue rather than design feature.

3. Storage of Compressed Gas Cylinders – General

Location/Design

1. Laboratory design shall include a storage area for cylinders of compressed gases where:

- **They are protected from external heat sources such as flame impingement, intense radiation heat, electric arc, or high temperature streamlines.**
- **They are in a well-protected, well-ventilated, dry location at least 20 feet from highly combustible materials.**

NFPA 55
NFPA 99, 4-3.1.2

2. Adequate space shall be made available for the segregation of gases by hazard class. Flammable gases shall not be stored with oxidizing agents. Separate storage for full or empty cylinders is required. Such enclosures shall serve no other purpose.

NFPA 55
NFPA 99, Section 4-1.2(a)2

3. Piping systems

- Systems for other compressed gases and for cryogenic materials shall comply with the manufacturer's design and specifications.
- Each point of use shall have an accessible manual shut-off valve.
- The manual shutoff valve at the point of use shall be located away from the potential hazards and be located within 1.8 m (6 ft) of the point of use.
- Where the cylinder valve is located within immediate reach, a separate point-of-use shutoff valve shall not be required.
- Line regulators that have their source away from the point of use shall have a manual shutoff valve.
- An emergency gas shutoff device in an accessible location at the exit shall be provided in addition to the manual point-of-use valve in each educational and instructional laboratory space that has a piped gas–dispensing valve.
- Each and every portion of a piping system shall have uninterrupted pressure relief.
- Any part of the system that can be isolated from the rest of the system shall have adequate pressure relief.

- Piping shall be designed for a pressure greater than the maximum system pressure that can be developed under abnormal conditions. The system must be designed to a minimum of 1-1/2 times working pressure.
- A pressure relief system shall be designed to provide a discharge rate sufficient to avoid further pressure increase and shall vent to a safe location.
- Permanent piping shall be identified at the supply point and at each discharge point with the name of the material being transported.
- Piping systems, including regulators, shall not be used for gases other than those for which they are designed and identified unless a thorough review of the design specifications, materials of construction, and service compatibility is made and other appropriate modifications have been made.
- The piping and piping system shall be certified by an objective, qualified third party or the authority having jurisdiction to test and will provide certification and ample documentation proving piping and system integrity.

NFPA 45

4. Design features which are prohibited:

- **Unventilated enclosures such as lockers, cold rooms, and cupboards.**

Oxygen cylinders shall not be stored near highly combustible materials especially oil or grease, or near any other substances likely to cause or accelerate fire.

5. Liquefied fuel-gas cylinders shall be stored in an upright position so that the safety relief device is in direct contact with the vapor space in the cylinder at all times.

NFPA 55

6. The heating of flammable gas storage areas/facilities shall only be heated with the buildings new or existing environmental or climate control such as air, steam, hot water, etc.

Good Practice per UH EHLS

Cylinder Restraint Systems

7. Laboratory design shall include restraints for the storage of cylinders greater than 26 inches tall. The restraint system shall include at least two (2) restraints made of non-combustible materials, which are located at one-third and two-thirds, the height of the cylinder.

NFPA 45, 8.1.5
NFPA 99, 4-3.1.1.2.3

A restraint system of chains, metal straps, or storage racks provides a reliable method of securing gas cylinders. Chains or metal straps at the bottom and top one third of each

cylinder provide protection against tipping and falling. [Work Practice Note: When compressed gas cylinders in service, they shall be adequately secured by chains, metal straps, or other approved materials, to prevent cylinders from falling or being knocked over.]

- 8. The purchase and installation of compressed gas cylinder securing systems must be subject to review of EHLS.**

Good Practice per UH EHLS

EHLS can assist in identifying good quality securing systems.

- 9. Gas cylinder securing systems should be anchored to a permanent building member or fixture.**

Good Practice per UH EHLS

Connection to a permanent building member or fixture is needed to prevent movement.

D. Storage of Compressed Gas Cylinders – Toxic and Highly Toxic Gases

Note: The following requirements apply to occupancies only.

- 1. Laboratory design shall incorporate storage capabilities of compressed gas cylinders of toxic and highly toxic gases per the following table. The number of lecture bottle cylinders [approximately 5 cm x 33 cm (2 in. x 13 in.)] shall be limited to 6.**

Table 6-1

	Flammable or Oxidizing Gases		Liquefied Flammable Gases		Gases with Health Hazard Rating of 3 or 4
	Sprinklered Space	Non-sprinklered Space	Sprinklered Space	Non-sprinklered Space	Non-Sprinklered or Sprinklered Space
Max. no. of cylinders per 46.5m² (500)	6	3	3	2	3

ft²) or less

NFPA 45, Table 8-1

Storage Systems

2. **Laboratory design shall include one of the following storage systems for toxic and highly toxic compressed gas cylinders:**
 - **Ventilated gas cabinets/exhausted enclosures/laboratory fume hoods, or**
 - **Separate ventilated gas storage rooms without other occupancy or use which have explosion control.**

Good Practice per UH EHLS

3. **When gas cabinets or exhausted enclosures are provided, they shall:**
 - a) **Be located in a room or area which has independent exhaust ventilation;**
 - b) **Operate at negative pressure in relation to the surrounding area;**
 - c) **Have self-closing limited access parts or non-combustible windows to provide access to equipment controls with an average face velocity of at least 200 fpm and with a minimum of 150 fpm at any part of the access port or window, and with window design criterion of 200 fpm at the cylinder neck when the average face velocity is >200 fpm.**
 - d) **Be connected to an exhaust system;**
 - e) **Have self-closing doors and be constructed of at least 0.097 inch (12 gauge) steel;**
 - f) **Be anchored;**
 - g) **Contain no more than three (3) cylinders per gas cabinet, except where cylinder contents are one (1) pound net or less, in which case gas cabinets may contain up to 20 cylinders;**
 - h) **Be fitted with sensors connected to alarms to notify in the event of a leak, or exhaust system failure.**

Good Practice per UH EHLS

4. **When separate gas storage rooms are provided, they shall:**
 - a) **Operate at a negative pressure in relation to the surrounding area;**

b) Direct the exhaust ventilation to an exhaust system.

Good Practice per UH EHLS

Treatment

5. Treatment systems for the exhaust of toxic and highly toxic gases must be reviewed and approved by EHLS.

EHLS Policies & Procedures

EHLS reviews treatments systems to ensure they are compliant and consistent.

Emergency Power

6. Emergency power shall be provided for exhaust ventilation, gas-detection systems, emergency alarm systems, and temperature control systems.

Good Practice per UH EHLS

Detection System

7. A continuous gas detection system shall be provided for Class I and II toxic gases to detect the presence of gas at or below the permissible exposure limit in occupied areas and at or below ½ the IDLH (or 0.05 LC50 if no established IDLH) in unoccupied areas. The detection system shall initiate a local alarm and transmit a signal to a fire alarm system activating an auditable alarm notifying building occupants of a toxic gas release. Activation of the monitoring system shall automatically close the shut-off valve on toxic and highly gas supply lines to the system being monitored.

Good Practice per UH EHLS

Guidance about the gases to be monitored, alarm set points, and where and how the alarms annunciate must be provided by the campus EHLS.

8. An approved supervised smoke detection system shall be provided in rooms or areas where highly toxic compressed gases are stored indoors. Heat detectors may replace smoke detectors.

Security

9. Storage areas shall be secured unauthorized entry.

10. Failsafe exhaust interlock – Should the system detect a loss of exhaust the detection system shall initiate a local alarm and transmit a signal to a fire alarm system activating an alarm.

11. Signage is required for toxic cylinder rooms clearly marked “DO NOT ENTER”.

Good Practice per UH EHLS

E. Storage of Compressed Gas Cylinders – Medical Gases

- 1. Enclosures such as 1-hour interior and exterior rooms (detailed below) must be provided for supply systems cylinder storage or manifold locations for oxidizing agents such as oxygen and nitrous oxide. Such enclosures must be constructed of an assembly of building materials with a fire-resistive rating of at least one (1) hour and must not communicate directly with anesthetizing locations.**

NFPA 99, Sections 4-3.1.1.2(a).2

Other nonflammable (inert) medical gases may be stored in the enclosure. Flammable gases shall not be stored with oxidizing agents. Storage of full or empty cylinders is permitted. Such enclosures shall serve no other purpose.

- 2. A 1-hour exterior room shall be a room or enclosure separated from the rest of the building by not less than 1-hour-rate fire-resistive construction. Openings between the room or enclosure and interior spaces shall be smoke-and draft-control assemblies having no less than a 1-hour fire-protection rating. Rooms shall have at least one exterior wall provided with at least two vents. Each vent shall not be less than 36 square inches in area. One vent shall be within 6 inches of the floor and one shall be within 6 inches of the ceiling. Containers of medical gases shall be provided with at least one fire sprinkler to provide container cooling in case of fire.**

NFPA 99

- 3. When an exterior wall cannot be provided for the room, automatic sprinklers shall be installed within the room. The room shall be exhausted through a duct to the exterior. Makeup air to the room shall be taken from the exterior. Both separate air streams shall be enclosed in a 1-hour-rated shaft enclosure from the room to the exterior. Approved mechanical ventilation shall be in accordance with the International Mechanical Code and provided at a minimum rate of one (1) cubic foot per minute per square foot of the room area.**
- 4. Medical gas system cabinets shall be in accordance with the following:**
 - a. Operated at a negative pressure in relation to surrounding area,**
 - b. Provided with self-closing, limited-access ports or noncombustible windows to give access to equipment controls. The average velocity of ventilation at the face of access ports or windows shall not be less than 200 feet per minute with a minimum of 150 feet per minute at any point of the access port or window,**
 - c. Connected to an exhaust system,**
 - d. Provided with a self-closing door,**
 - e. Constructed of not less than 0.097-inch (12 gauge) steel.**

F. Design of Systems and Apparatus for Cryogenic Fluids

- 1. The position of valves and switches for emergency shutdowns shall be accessible and clearly labeled.**

Good Practice per UH EHLS

G. Design of Pressure Vessels and Systems

- 1. Normal and emergency relief venting and vent piping for pressure vessels should be adequate and in accordance with the design of the vessel.**

ASME Boiler and Pressure Vessel Code for Unfired Pressure Vessels.

Section 1.4

FLAMMABLE LIQUID STORAGE CABINETS

TABLE OF CONTENTS

		<u>Page</u>
A.	Regulations, Standards and References	1.4.2
B.	Scope	1.4-2
C.	Design	1.4-2
D.	Construction	1.4-3
E.	Location	1.4-4

A. Regulations, Standards and References

NFPA 30 Chapter 4
NFPA 101 Life Safety Code
NFPA 45

B. Scope

Flammable liquid storage cabinets are intended for the storage of flammable and combustible liquids. This Guide applies to all UH facilities including leased properties. It covers the design, construction, and installation of Flammable Liquid Storage Cabinets. The Guide does not address the proper use of Flammable Liquid Storage Cabinets.

C. Design

Approval/Submittal

1. Flammable Liquid Storage Cabinets must be UL listed and must meet all NFPA Codes.

NFPA

UL listing and EHLS approval assures a minimum level of quality consistent with code requirements and good practice.

Cabinet Capacity

2. **Where flammable liquid storage cabinets are required, they shall be designed such that they do not exceed 60 gallons for the combined total quantity of all liquids (i.e., Classes 1, 2, and 3).**

NFPA 30, Chapter 4-3.1

One or more Flammable Liquid Storage Cabinets are required for laboratories which store, use, or handle more than 10 gallons of flammable or combustible liquids depending on location.

Labeling

3. **Flammable Liquid Storage Cabinets shall conspicuously be labeled in red letters on contrasting background “FLAMMABLE – KEEP FIRE AWAY.”**

NFPA 30, Chapter 4-3.5

4. **When flammable or combustible liquids present multiple hazards, the laboratory design shall address the storage requirements for each hazard.**

NFPA 30, NFPA 45

For example, acetic acid is a corrosive and flammable material. Therefore, if stored in a flammable cabinet with other flammable materials, it must be segregated through the use of separate barriers (e.g., secondary containment). Incompatible material shall not be stored within the same cabinet.

D. Construction

Materials

1. **New Flammable Liquid Storage Cabinets must be constructed of steel and UL approved.**

Good Practice per UH EHLS
Wood Cabinets are not UL listed or EHLS approved.

2. **Flammable Liquid Storage Cabinets shall be constructed as follows:**

1. **Minimum wall thickness of 0.044 inches (18 gauge).**
2. **Double walled construction with a minimum air gap of 1-1/2 inches between the walls including the door, top, bottom, and sides.**
3. **Tight-fitting joints welded or riveted.**
4. **Liquid-tight bottom with a doorsill of at least 2 inches.**

5. Three-point latch on doors.

NFPA 30, Section 4-4.4(b)
Good Practice per UH EHLS

Doors

3. Cabinet doors shall be self-closing and self-latching.

Good Practice per UH EHLS

Venting

- 4. Flammable Liquid Storage Cabinets are not required to be vented, except for odor control of malodorous materials. Vent openings shall be sealed with the bungs supplied with the cabinet or with bungs specified by the manufacturer of the cabinet. If vented, cabinet should be vented from the bottom with make-up air supplied to the top. It should be vented to an approved location or through a flame arrester to a fume hood exhaust system. Construction of the venting duct should be equal to the rating of the cabinet.**

NFPA 30, Chapter 4-3.4
NFPA 99, Chapter 10-7,2.3

E. Location

- 1. Flammable Liquid Storage Cabinets shall NOT be located near exit doorways, stairways, or in a location that would impede egress.**

NFPA 101

- 2. Flammable Liquid Storage Cabinets must NOT be wall-mounted.**

Good Practice per UH EHLS
Wall-mounted cabinets are not UL Listed or Fire Marshal Approved.

- 3. Laboratory design must ensure that Flammable Liquid Storage Cabinets are NOT located near an open flame or other ignition source.**

Good Practice per UH EHLS

An open flame or other ignition source could start a fire or cause an explosion if an accident or natural disaster brought the ignition source and flammable liquids or vapors together.

F. Electrical Bonding

- a. **All flammable storage cabinets are equipped with electrical bonding lugs to prevent static charge. All cabinets must be bonded with an NEC approved method.**

Section 1.5

HAZARDOUS MATERIALS STORAGE

TABLE OF CONTENTS

		<u>Page</u>
A.	Regulations	1.5.2
B.	Scope	1.5-2
C.	Requirements	1.5-2
D.	Procedures	1.5-3
E.	Tables	1.5-5

A. Regulations

NFPA 101 Life Safety Code
NFPA 1 Fire Code Handbook
NFPA 30

B. Scope

This design guide applies to the storage of hazardous materials. As noted in the introduction, the use of hazardous materials has direct bearing on the design of the laboratory, hence, the research operations should be well understood in the planning phases when designing the laboratory's hazardous materials storage.

C. Requirements

1. Laboratory design shall include spill control and secondary containment for the storage of hazardous materials liquids in accordance with the requirements of NFPA 30.

Notes:

- a) Design must allow for substances which, when mixed, react violently, or evolve toxic vapors or gasses, or which in combination become hazardous by reason of toxicity, oxidizing power, flammability, explosiveness, or other properties, to be separated from each other in storage by distance or by partition, so as to preclude accidental contact between them.
- b) Explosion control shall be provided as required by NFPA 30 and NFPA 1 for storage of non-exempt quantities of the following materials.
 - Highly toxic flammable or toxic flammable gases when not stored in gas cabinets, exhausted enclosures or gas rooms.
 - Combustible dusts.
 - Class 4 oxidizers.
 - Unclassified detonable and Class 1 organic peroxides.
 - Pyrophoric gases.
 - Class 3 and 4 unstable (reactive) materials.
 - Class 2 and 3 water-reactive solids and liquids.

2. When the hazardous materials stored in a control area are not in excess of the amounts specified in the tables below, such storage shall conform to the Building Code requirements:

NFPA 30

3. When the hazardous materials stored in a control area exceed the amounts, such storage shall conform to the International Building Code requirements for Group H, Division 7 (“H-7”) Occupancy and all NFPA code requirements.

International Building Code

NFPA 45

D. Procedures

The following permitting and reporting procedures have design and project approval implications for any facilities project.

1. NFPA 45 Chemical Inventory Report Procedure as noted in this and other sections, the quantity of hazardous chemicals planned for use and storage within a project area has a direct impact on how the project is designed. This procedure should be implemented at the point that a form is submitted. The end result of the procedure is a summarized report showing the quantities of hazard classes planned for a project compared to limits shown

in NFPA 45 Appendix 1 of this section. Contact the UH Fire Marshal for further information.

2. Texas Commission on Environmental Quality (TCEQ)

Laboratory ventilation and fume hoods and some other laboratory equipment are considered as permit by rule emission sources by the TCEQ.

3. Hazardous Waste Generator “registration” for “off-campus” facilities

Projects within the “campus site” are covered by the University’s existing Hazardous Waste Generator “registration”. Projects that are “off-site” must obtain a Hazardous Waste Generator “registration” before procedures that result in chemical wastes can be conducted. Contact UH EHLS for guidance and assistance.

4. Hazardous Material Storage shall comply with NFPA 45 per type of occupancy. See NFPA 45.10.1

Section 2

ADDITIONAL REQUIREMENTS FOR LABORATORIES USING RADIOACTIVE MATERIALS, RADIATION PRODUCING MACHINES, OR LASERS

TABLE OF CONTENTS

		<u>Page</u>
A.	Regulations, Standards and References	2-2
B.	Scope	2-2
C.	Decommissioning of Existing Facilities Prior to Demolition or Renovation	2-2
D.	Design Features for Radiological Labs	2-3
E.	Laser Radiation Items	2-4
F.	Ventilation Considerations	2-5
G.	Laser Ventilation Considerations	2-5

A. Regulations, Standards and References

Regulations:

- Code of Federal Regulation (CFR) 10, Parts 20 and 35
- 25 Texas Administrative Code (TAC) 289
- UH EHLS Radiation Safety Manual (STIPULATED IN LICENSE)

University Policies:

- Policies of the UH Radiation Safety Committee

Recommendations:

- “Guide for the Preparation of Applications for Medical Programs” (RH 2010 4/90) (not formally adopted) (DOHS 2010)
- “Safe Handling of Radioactive Materials,” National Council on Radiation Protection (NBS Handbook 92)
- “Safe Handling of Radionuclides,” International Atomic Energy Agency (IAEA), Safety Series No. 1, (1973 ed. Is still current as of 1999)
- “Structural Shielding and Evaluation for Medical Use of X-rays and Gamma Rays of Energies up to 10 Me,” National Council on Radiation Protection, Report No. 49
- “Radiation Protection Design Guidelines for 0.1-100MeV Particle Accelerators,” National Council on Radiation Protection, Report No. 51, (NCRP51)
- Guide for the Preparation of Applications for Type A Licenses of Broad Scope, 2nd Proposed Revision 2 Regulatory Guide 10.5, Revision 2, USNRC (NRC10.5)
- “Recommendations for the Safe Use of LASERS,” American National Standards Institute. (ANSI Z136.1)
- Radiation Protection in Educational Institutions NCRP 157

B. Scope

All radioactive materials used at UH are governed by the terms and conditions of the UH Radioactive Materials License issued by the Department of Health Services.

C. Decommissioning of Existing Facilities Prior to Demolition or Renovation

Decommissioning of existing facilities is an activity regulated by the State of Texas, contact Radiation Safety as early as possible (at least 120 days) before the planned initiation of construction. A plan for decommissioning must be drafted and submitted to the EHLS Radiation Safety, approved, and executed. A report of findings with corrective actions stipulated must be submitted to the UH EHLS and approved before demolition, renovation, or construction can begin.

D. Design Features for Radiological Labs

Approval Process

- 1. Proposals for new facilities must be submitted to the Radiation Safety Committee via Radiation Safety Officer for review. New facilities must require the approval of the Radiation Safety Committee prior to construction.**

UH EHLS Radiation Safety Manual

- 2. Shared facilities for the use of radioactive materials should not be included in plans for new buildings. If such facilities are deemed absolutely necessary, the facility must be under the direction, control and authority of a single principal investigator, who shall be accountable for maintaining the facility in a safe and orderly manner.**

UH EHLS Radiation Safety Manual

Architectural Considerations

- 3. Benches in laboratories must be capable of supporting weight of necessary shielding for gamma rays.**

NBS Handbook 92
IAEA Safe Handling of Radionuclides

- 4. When work involves gamma emitters (especially gamma irradiators) the floors and coatings must be able to support the gamma shielding.**

NBS Handbook 92
IAEA, Safe Handling of Radionuclides

- 5. When applicable, lead shielding must be incorporated in the structure. Based on the proposed type and quantities of radioactive materials, the Radiation Safety Program will determine the need for the shielding.**

Note that for the x-ray producing machines, shielding calculations will be performed by qualified personnel. Shielding design is to be in accordance with all applicable State Regulations and NCRP and ANSI standards. During construction the shielding must be inspected by the Radiation Safety while walls are open. After completion, the effectiveness of the installed shielding and protective design features shall be evaluated by the Radiation Safety Program.

National Council on Radiation Protection, Report No. 147

Security

- 6. Areas where radioactive materials or other radiation sources are used or stored shall be provided with adequate security (e.g., locks) to prevent removal or use by unauthorized personnel.**

UH EHLS Radiation Safety Manual

- 7. High radiation areas or very high radiation areas (as defined in 10 CFR 20.1602-2) shall be equipped with means to prevent inadvertent access and restrict access to only authorized personnel. Means to reduce exposure levels in the area may be**

required via an interlock device. In some applications, means to monitor the radiation levels in the areas shall be provided.

10 CFR 20, 1601-2

8. **High radiation areas or very high radiation areas (as defined in 10 CFR 20.1602-2) shall be equipped with a control device that energizes a conspicuous visible or audible signal so that an individual entering the area and the operator of the device are made aware of the entry.**

10 CFR 20, 1601-2

Waste Storage

9. **Adequate space must be available for radioactive wastes generated by projects within the lab. Most radioisotope projects will need about 10 sq. ft. of floor space for containers and shields within a lockable area. Radioactive wastes must be properly segregated by half-life categories. Secondary containment and appropriate flooring with non-porous material is required.**

UH EHLS Radiation Safety Manual

E. Laser Radiation Items

1. **Class IIIb and IV Laser facilities must be equipped with adequate shielding (e.g., thermal curtains using materials approved by the University's Fire Marshal, window glass that does not transmit direct laser radiation or the specular or diffuse reflections of the laser radiation (shutters or filters)). Portals and viewing windows must be designed to prevent any exposure above the permissible threshold limit value.**

ANSI Z136.1, 25 TAC 289.301

2. **Class IIIb and Class IV laser facilities must be in rooms secured by locks. Class IV laser installations must be provided with interlocked warnings that indicate the status of the laser prior to entering the facility.**

ANSI Z136.1, 25 TAC 289.301

3. **All Electrical outlets must be placed a minimum of 4 inches above the work surface unless a GFCI is installed. Flush mounting to the work surface is not acceptable.**

ANSI Z136.1

F. Ventilation Considerations

1. **Ventilation requirements for the laboratories utilizing radioactive materials are dependent upon the types of materials used. Facilities that use radioactive gases shall be equipped with ventilation to adequately maintain concentrations to below allowable occupational exposure levels and to not permit escape of the gas to adjacent non-use areas such that concentrations exceed those allowed for**

uncontrolled areas. These range from no special requirements to those requiring separate exhaust systems equipped with “panic button” shut down switches. The Radiation Safety Committee will review the proposed uses and make specific recommendations appropriate for each facility.

10 CFR 20: Appendix B
UH EHLS Radiation Safety Manual

- 2. Depending on the type and quantities of radioactive materials or the location of the facility, fume hoods used with volatile radioactive materials have specific design requirements. These are detailed in the Fume Hoods section of this Design Guide.**

G. Laser Ventilation Considerations

- 1. Appropriate ventilation to remove laser generated airborne contaminants must be provided for Class IIIb and IV lasers.**

ANSI Z136.1

- 2. Gas cabinets and adequate ventilation must be provided to mitigate the hazards associated with excimer laser gases or other lasers using toxic gases.**

- 3. All MRIs must meet applicable codes.**

- 4. TESLA Magnets**

Section 3

BIOSAFETY LEVEL 2 LABORATORIES

TABLE OF CONTENTS

		<u>Page</u>
A.	Codes, Standards and References	3-2
B.	Scope	3-2
C.	Ventilation Considerations for Biosafety Level 2 Laboratories	3-2
D.	Biological Safety Cabinets and Other Containment Considerations	3-3

E.	Biohazardous/Medical Waste	3-6
F.	Additional Considerations for Biosafety Laboratories	3-6

A. Codes, Standards, and References

National Fire Protection Association (NFPA) Standard 45, Fire Protection for Laboratories

The Centers for Disease Control and Prevention (CDC) and the National Institutes of Health (NIH), *Primary Containment for Biohazards: Selection, Installation and Use of Biological Safety Cabinets, 2nd Edition*

The Centers for Disease Control and Prevention (CDC) and the National Institutes of Health (NIH), *Biosafety in Microbiological and Biomedical Laboratories, 5th Edition*

NIH Guidelines for Research Involving Recombinant DNA Molecules, March 2013

National Sanitation Foundation (NSF) International Standard 49

B. Scope

All of the biological research conducted at the University of Houston involves low to moderate risk etiological agents as defined by the (NIH), Section 1, of this Guide, General Requirements for UH laboratories, covers all design requirements for Biosafety Level 1 laboratory work areas. This section focuses primarily on the biosafety considerations for a Biosafety Level 2 laboratory.

C. Ventilation Considerations for Biosafety Level 2 Laboratories

- 1. Air pressure in laboratories and animal care rooms should be negative in relation to the corridor or adjacent non-laboratory areas. Rooms housing immunocompromised animals should be at a positive pressure with respect to adjoining areas. Consult with EHLS for design details.**

CDC-NIH Biosafety in Microbiological and Biomedical Laboratories (ABSL 2, D.5)

Potentially harmful aerosols can escape from the containment of the laboratory room unless the room air pressure is negative to adjacent non-laboratory areas. As a general rule, air should flow from low hazard to high hazard areas.

- 2. Dedicated sterile tissue culture rooms should be balanced neutral or slightly positive with respect to adjoining areas. Tissue culture rooms that involve the use of biohazardous agents shall be negative as stated in C-1 above.**

Good Practice per UH EHLS

This will minimize the potential for possible contamination of experiments within these rooms.

- 3. An autoclave shall be provided with a canopy hood, slotted exhaust, or other suitable means of local exhaust. In addition, autoclave rooms should have a minimum of 10 air changes per hour.**

Good Practice per UH EHLS

Unpleasant heat and odors will linger in the room unless provided with effective local exhaust and adequate frequency of air changes.

D. Biological Safety Cabinets and Other Containment Considerations

Approval/Type

- 1. All Biological Safety Cabinets (BSC) must be National Science Foundation (NSF) listed, UL approved, and installed in accordance with the manufacturer's requirements.**

Good Practice per UH EHLS

Cabinets, which when used and installed properly, will provide both product and personnel protection. However, if the cabinet is not installed properly (e.g., not ducting a Class II, B2 cabinet), then it will not be serviceable. Installation of a cabinet, which deviates from the listed NSF requirements, will void the NSF Standard 49 approved listing.

- 2. Biosafety Level 2 applications involving toxic chemicals or radionuclides, a Class II-B type cabinet must be installed.**

Good Practice per UH EHLS

Class II-B cabinets do not allow in-room venting of exhaust air and are thus appropriate for such uses. For Biosafety Level 2 applications, fume hoods are not appropriate; a fume hood is not designed for the usage of biological materials. An appropriate biosafety cabinet must be used. The exact type of BSC should be specified early in the design process.

Venting

- 3. The Biosafety cabinet shall be vented from the building if toxic or malodorous chemicals are used. A thimble connection to the exhaust is one way to exhaust a Class IIA cabinet.**

Fume hoods shall not vent into a BSC system. A dedicated duct or manifold system shall be used.

Primary containment for Biohazards, CDC/NIH

Good Practice per UH EHLS

4. Venting to external ducts shall be monitored.

Good Practice per UH EHLS

Where cabinets are connected to external ducts, a flow monitoring system with audible and visual annunciators shall be used to alert the cabinet users of loss of external ventilation. Alternatively, thimble connections or canopy mini-enclosures in cabinets shall be fitted with a ribbon streamer or equivalent attached at an edge through which air enters the device to indicate the airflow direction.

Location

5. Biological safety cabinets (BSCs) must be located away from doors and other high traffic areas.

NSF Standard 49, Annex E, I.A.1

Currents of air can disrupt and degrade the protective capability of the cabinet. All attempts should be made to neutralize any interference.

6. A biosafety cabinet should not be installed directly opposite of another biosafety cabinet or fume hood if spatial considerations allow otherwise.

NSF Standard 49, Appendix E

Laminar airflow is greatly hindered by the operation of a biosafety cabinet located directly opposite of another biosafety or autoclave. It is recommended to provide at least six feet between cabinets.

7. A biosafety cabinet should not be installed directly under air supply inlets.

NSF Standard 49, Appendix E

External air currents degrade the effectiveness of Biosafety cabinets. If possible, locate cabinets where air supply inlets will not interfere with performance.

8. A Biosafety cabinet should not be installed within 10 feet of an autoclave.

Good Practice per UH EHLS

Exhaust from an autoclave may contain heat and moisture that will blow into the face of the cabinet. This will cause air turbulence in the cabinet and adversely affect the performance of the unit. There is also an increase of potential contamination within the cabinet if the autoclave is not functioning properly since the steam may contain spores or aerosols.

9. A 12-inch clearance should be provided behind and on each side of the cabinet to allow easy access for maintenance, and to ensure that the air return to the

laboratory is not hindered. When the BSC is hard-ducted or connected by thimble unit to the ventilation system adequate space must be provided so as not to interfere with air flow.

10. Only non-ducted biosafety cabinets shall be considered for installation.

Primary containment for Biohazards, CDC/NIH

These placement considerations are required to ensure maximum effectiveness of the primary barrier (BSC).

Natural Gas

11. Open flames shall not be used in Biosafety Cabinets

Good Practice per UH EHLS

UH EHLS has taken a strong stance against the use of gas burners or alcohol flames in Biosafety cabinets. The decision has been made in accordance with recommendations from numerous agencies. The Center for Disease Control and Prevention (CDC) reports that ‘open-flames are not required in the near microbe-free environment of a biological safety cabinet’ and create ‘turbulence which disrupts the pattern of air supplied to the work surface’ jeopardizing the sterility of the work area. This is also the recommendation of the World Health Organization (WHO) as well as the major Biosafety cabinet manufacturers.

Natural gas shutoffs shall be placed within arm’s reach, a maximum of 24”, from the from the lab egress door frame.

Autoclaves

12. Design provisions should be implemented and EHLS shall be consulted in the event of potentially infections spores, chemicals, or instruments need to be disinfected/sterilized.

Natural gas lines must be painted yellow for ease of identification.

CDC-NIH Biosafety in Microbiological and Biomedical Laboratories (BSL 2, D.6)

Guidelines for Research involving Recombinant DNA Molecules (NIH Guidelines) App. G-II-B-4-f

E. Biohazardous/Medical Waste

Biohazardous waste must be contained in appropriate secondary containers prior to disposal

Good Practice per UH EHLS

Biohazardous and medical waste must be placed in ‘red bags’ which are located within approved secondary containment. These waste receptacles are in addition to the non-hazardous waste bins

used within the laboratory. Sufficient floor space must be planned in order to have enough room for the necessary waste containers.

F. Additional Considerations for Biosafety Research Laboratories

A. BSL 1

1. Laboratories should have doors for access control.
2. Laboratories must have a sink for hand washing.
3. The laboratory should be designed so that it can be easily cleaned. Carpets and rugs in laboratories are not appropriate.
4. Laboratory furniture must be capable of supporting anticipated loads and uses. Spaces between benches, cabinets, and equipment should be accessible for cleaning.
 - a. Bench tops must be impervious to water and resistant to heat, organic solvents, acids, alkalis, and other chemicals.
 - b. Chairs used in laboratory work must be covered with a non-porous material that can be easily cleaned and decontaminated with appropriate disinfectant.

B. BSL2

1. Laboratory doors should be self-closing and have locks in accordance with the institutional policies.
2. Laboratories must have a sink for hand washing. The sink may be manually, hands-free, or automatically operated. It should be located near the exit door.
3. The laboratory should be designed so that it can be easily cleaned and decontaminated. Carpets and rugs in laboratories are not permitted.
4. Laboratory furniture must be capable of supporting anticipated loads and uses. Spaces between benches, cabinets, and equipment should be accessible for cleaning.
 - a. Bench tops must be impervious to water and resistant to heat, organic solvents, acids, alkalis, and other chemicals.
 - b. Chairs used in laboratory work must be covered with a non-porous material that can be easily cleaned and decontaminated with appropriate disinfectant.
5. BSCs must be installed so that fluctuations of the room air supply and exhaust do not interfere with proper operations. BSCs should be located away from doors, windows that can be opened, heavily traveled laboratory areas, and other possible airflow disruptions.
6. Vacuum lines should be protected with liquid disinfectant traps.
7. An eyewash station must be readily available.
8. There are no specific requirements for ventilation systems. However, planning of new facilities should consider mechanical ventilation systems that provide an inward flow of air without recirculation to spaces outside of the laboratory.

9. HEPA filtered exhaust air from a Class II BSC can be safely recirculation back into the laboratory environment if the cabinet is tested and certified at least annually and operated according to manufacturer's recommendations. BSCs can also be connected to the laboratory exhaust system by either a thimble (canopy) connection or directly exhausted to the outside through a hard connection. Provisions to assure proper safety cabinet performance and air system operation must be verified.
10. A method for decontaminating all laboratory wastes should be available in the facility (e.g., autoclave, chemical disinfection, incineration, or other validated decontamination method).

C. BSL 3

1. Laboratory doors must be self-closing and have locks in accordance with the institutional policies. The laboratory must be separated from areas that are open to unrestricted traffic flow within the building. Laboratory access is restricted. Access to the laboratory is through two self-closing doors. A clothing change room (anteroom) may be included in the passageway between the two self-closing doors.
2. Laboratories must have a sink for hand washing. The sink must be hands-free or automatically operated. It should be located near the exit door. If the laboratory is segregated into different laboratories, a sink must also be available for hand washing in each zone. Additional sinks may be required as determined by the risk assessment.
3. The laboratory must be designed so that it can be easily cleaned and decontaminated. Carpets and rugs are not permitted. Seams, floors, walls, and ceiling surfaces should be sealed. Spaces around doors and ventilation openings should be capable of being sealed to facilitate space decontamination.
 - a. Floors must be slip resistant, impervious to liquids, and resistant to chemicals. Consideration should be given to the installation of seamless, sealed, resilient or poured floors, with integral cove bases.
 - b. Walls should be constructed to produce a sealed smooth finish that can be easily cleaned and decontaminated.
 - c. Ceilings should be constructed, sealed, and finished in the same general manner as walls.
 - d. Decontamination of the entire laboratory should be considered when there has been gross contamination of the space, significant changes in laboratory usage, for major renovations, or maintenance shut downs. Selection of the appropriate materials and methods used to decontaminate the laboratory must be based on the risk assessment.
4. Laboratory furniture must be capable of supporting anticipated loads and uses. Spaces between benches, cabinets, and equipment must be accessible for cleaning.
 - a. Bench tops must be impervious to water and resistant to heat, organic solvents, acids, alkalis, and other chemicals.
 - b. Chairs used in laboratory work must be covered with a non-porous material that can be easily cleaned and decontaminated with appropriate disinfectant.

5. BSCs must be installed so that fluctuations of the room air supply and exhaust do not interfere with proper operations. BSCs should be located away from doors, heavily traveled laboratory areas, and other possible airflow disruptions.
6. Vacuum lines must be protected with HEPA filters, or their equivalent. Filters must be replaced as needed. Liquid disinfectant traps may be required.
7. An eyewash station must be readily available in the laboratory.
8. A ducted air ventilation system is required. This system must provide sustained directional airflow by drawing air into the laboratory from “clean” areas toward “potentially contaminated” areas. The laboratory shall be designed such that under failure conditions the airflow will not be reversed.
 - a. Laboratory personnel must be able to verify directional airflow. A visual monitoring device, which confirms directional airflow, must be provided at the laboratory entry. Audible alarms should be considered to notify personnel of air flow disruption.⁴⁴
Biosafety in Microbiological and Biomedical Laboratories
9. Photohelic type directional flow devices must be calibrated annually and be connected to an emergency power source.
 - a. The laboratory exhaust air must not re-circulate to any other area of the building.
 - b. The laboratory building exhaust air should be dispersed away from occupied areas and from building air intake locations or the exhaust air must be HEPA filtered.
 - c. Caisson systems shall be tested and certified annually.
 1. HEPA filter housings shall have gas-tight isolation dampers, decontamination ports, and/or bag-in/bag-out (with appropriate decontamination procedures) capability. The HEPA filter housing should allow for leak testing of each filter and assembly using a DOP challenge using a 99.99% standard. The filters and the housing should be certified at least annually.
10. HEPA filtered exhaust air from a Class II BSC can be safely re-circulated into the laboratory environment if the cabinet is tested and certified at least annually and operated according to manufacturer’s recommendations. BSCs can also be connected to the laboratory exhaust system by either a thimble (canopy) connection or directly exhausted to the outside through a hard connection. Provisions to assure proper safety cabinet performance and air system operation must be verified. BSCs should be certified at least annually to assure correct performance. Class III BSCs must be directly (hard) connected up through the second exhaust HEPA filter of the cabinet. Supply air must be provided in such a manner that prevents positive pressurization of the cabinet.
11. A method for decontaminating all laboratory wastes should be available in the facility, preferably within the laboratory (e.g., autoclave, chemical disinfection, or other validated decontamination method).
12. Equipment that may produce infectious aerosols must be contained in primary barrier devices that exhaust air through HEPA filtration or other equivalent technology before

- being discharged into the laboratory. These HEPA filters should be tested and/or replaced at least annually.
13. Facility design consideration should be given to means of decontaminating large pieces of equipment before removal from the laboratory.
 14. Enhanced environmental and personal protection may be required by the agent summary statement, risk assessment, or applicable local, state, or federal regulations. These laboratory enhancements may include, for example, one or more of the following: an anteroom for clean storage of equipment and supplies with dress-in, shower-out capabilities; gas tight dampers to facilitate laboratory isolation; final HEPA filtration of the laboratory exhaust air; laboratory effluent decontamination; and advanced access control devices, such as biometrics.
 15. The BSL-3 facility design, operational parameters, and procedures must be verified and documented prior to operation. Facilities must be re-verified and documented at least annually.
 16. Fans should incorporate direct drive motors or close coupled (not belt driven).

GLOSSARY

Biohazardous Materials: Infectious agents, the products of infectious agents, or the components of infectious agents presenting a risk of injury or illness.

Biosafety Level: Biosafety levels consist of laboratory practices and techniques, safety equipment, and a laboratory facility appropriate for the operations performed and the hazard posed by the particular biohazard material. The Centers for Disease Control (CDC) and the National Institute of Health (NIH) define the four biosafety levels in the publication, *Biosafety in Microbiological and Biomedical Laboratories*, 1988 and revisions, and recommend biosafety levels for particular pathogenic microorganisms.

Biosafety Cabinet (BSC)¹: A ventilated cabinet, which serves as a primary containment device for operations involving biohazard materials. The three classes of biosafety cabinets are described below:

Class I Biosafety Cabinet: The Class I biosafety cabinet is an open-fronted negative-pressured ventilated cabinet with a minimum inward average face velocity at the work opening of at least 75 feet per minute. The exhaust air from the cabinet is filtered by a HEPA filter and discharged without recirculation.

Class II Biosafety Cabinet: The Class II biosafety cabinet is an open-fronted, ventilated cabinet. Exhaust air is filtered with a high efficiency particulate air filter (HEPA). This cabinet provides HEPA-filtered downward airflow within the workspace. Class II Cabinets are further classified as type A, type B1, type B2 and type B3.

Class II, type A (non-ducted), biosafety cabinets may have positive pressure contaminated internal ducts and may exhaust HEPA-filtered air back into the laboratory. Shall provide a minimum inward average face velocity of 75 feet per minute at the work opening.

Class II type B1 cabinets have all biologically contaminated internal ducts or plenums under negative pressure or surrounded by negative pressure ducts or plenums, exhaust HEPA filtered air through external ducts to space outside the laboratory, and have HEPA filtered down flow air composed largely of unrecirculated inflow air.

Class II type B2 cabinets (also known as “total exhaust” cabinets) have all biologically contaminated internal ducts or plenums under negative pressure or surrounded by negative pressure ducts or plenums, exhaust HEPA filtered air through external ducts to space outside the laboratory, and have HEPA filtered down flow air drawn from the laboratory or outside air.

Class II type B3 cabinets (also known as “convertible” cabinets) have all biologically contaminated internal ducts or plenums under negative pressure or surrounded by negative pressure ducts or plenums, exhaust HEPA filtered air through external ducts to space outside the laboratory, and have HEPA filtered down flow air that is a portion of the mixed down flow and inflow air from a common exhaust plenum.

Boiling Point: The temperature at which the vapor pressure of a liquid equals the surrounding atmospheric pressure. For purposes of defining the boiling point, atmospheric pressure shall be considered to be 14.7 Pisa (760 mm Hg).

NFPA 1

Carcinogen: A substance is considered to be a carcinogen if:

- a) It has been evaluated by the International Agency for Research on Cancer (IARC) Monographs and found to be a carcinogen or potential carcinogen; or
- b) It is listed as a carcinogen or potential carcinogen in the Sixth Annual Report on Carcinogens published by the National Toxicology Program (NTP) or,
- c) It is regulated by Fed/OSHA or Cal/OSHA as a carcinogen

Combustible Liquid: A combustible liquid shall be defined as any liquid that has a closed-cup flash point at or above 100°F (37.8°C).

- a) Class II Liquid. Any liquid that has a flash point at or above 100°F (37.8°C) and below 140°F (60°C).
- b) Class IIIA Liquid. Any liquid that has a flash point at or above 140°F (60°C) but below 200°F (93°C).
- c) Class IIIB Liquid. Any liquid that has a flash point at or above 200°F (93°C).

Compressed Gas:

- a) A gas or mixture of gases having a pressure exceeding 40 Pisa at 70°F in a container, or
- b) A gas or mixture of gases having a pressure exceeding 140 Pisa in a container at 130°F, regardless of the pressure at 70°F, or
- c) A liquid or mixture of liquids having a vapor pressure exceeding 40 Pisa at 100°F as determined by UFC Standard No. 9-5.

Containment: The combination of personal practices, procedures, safety equipment, laboratory design, and engineering features to minimize the exposure of workers to hazardous or potentially hazardous agents.

Control Area: A building or portion of a building within which the exempted amounts of hazardous materials are allowed to be stored, dispensed, used or handled.

Corrosive: A substance that causes visible destruction of, or irreversible alterations in, living tissue by chemical action at the site of contact. For example, a substance is considered to be corrosive if, when tested on the intact skin of albino rabbits by the method described by the U.S. Department of Transportation in Appendix A to 49 CFR Part 173, it destroys or changes irreversibly the structure of the tissue in 4 hours. This term does not refer to action on inanimate surfaces.

Decontamination: Removal or destruction of infectious agents; removal or neutralization of toxic agents.

Emergency shower: A unit that enables a user to have flushing fluid cascading over the entire body.

Explosive: A substance that causes a sudden almost instantaneous release of pressure, gas, and heat when subjected to sudden shock, pressure, or high temperature.

Eyewash: A device used to irrigate and flush the eyes.

Flammable Anesthetic Gas: A compressed which is flammable and administered as an anesthetic including cyclopropane, dimethyl ether, ethyl chloride, ethyl ether and ethylene.

Flammable Liquid: Any liquid that has a closed-cup flash point below 100°F (37.8°C).

- a) **Class I Liquid.** Any liquid that has a closed-cup flash point below 100°F (37.8°C) and a Reid vapor pressure not exceeding 40 psig at 100°F (37.8°C).
1. Class IA liquids shall include those liquids that have flash points below 73°F (22.8°C) and boiling points below 100°F (37.8°C).
 2. Class IB liquids shall include those liquids that have flash points below 73°F (22.8°C) and boiling points at or above 100°F (37.8°C).
 3. Class IC liquids shall include those liquids that have flash points at or above 73°F (22.8°C), but below 100°F (37.8°C).

NFPA 1

Flash Point: The minimum temperature of a liquid at which sufficient vapor is given off to form an ignitable mixture with air near the surface of the liquid or within the vessel used.

NFPA 1

Fume Hood: A device enclosed on three sides, as well as the top and bottom, with an adjustable sash or fixed partial enclosure on the remaining side. They are designed, constructed, and maintained so as to draw air inward by means of mechanical ventilation, and so that any operation involving hazardous materials within the enclosure does not require the insertion of any portion of a person's body other than the hands and arms into the work area. (Note: Laboratory fume hoods prevent toxic, flammable, or noxious vapors from entering the laboratory, present a physical barrier from chemical reactions, and serve to contain accidental spills).

All fume hoods must be certified per [ASHRAE 110-2013](#) protocol following installation within the lab, by an independent, third party certifying agency.

- Restricted Bypass Fume Hoods (Phoenix Valves) are designed for operation on a Variable Air Volume (VAV) exhaust system (not included with the fume hood). The bypass slots in these fume hoods have been designed to exhaust the minimum volume of

air through the fume hood when the sash is closed. All hoods must meet NFPA 45 standards.

- Open Bypass Fume Hoods are designed for controlled airflow patterns within the fume hood for Constant Air Volume (CAV) exhaust conditions. The bypass slots are an alternate route for air to enter the hood as the fume hood sash is closed. These slots are sized to ensure that as the sash is closed, the fume hood face velocity does not increase to more than three and one half (3.5) times the velocity when the sash is fully open. The bottom airfoil guides air into the hood along the work surface. This feature allows a more uniform internal velocity to be maintained within the hood and provides a continuous air stream to sweep fumes from the countertop workspace. All fume hoods must meet NFPA 45 standards.
- Air Sentry (Low Flow Concept) Fume Hood. The future of Fume Hood Technology is here, now, with Air Sentry fume hood. The Air Sentry High Performance Fume Hoods can reduce the required airflow within the laboratory space by as much as half the amount that is normally required by conventional fume hoods. Even though this fume hood operates with reduced exhaust volumes and face velocities, the Air Sentry fume hood actually outperforms conventional fume hoods in containment tests. This high efficiency hood can be used on either CAV, VAV, or a switched two-state exhaust system. The Air Sentry Series fume hoods feature the Vortex Controls System, which automates the back baffle to adjust for external influences which may affect hood performance.

Hazardous Material: A material for which there is statistically significant evidence based on at least one study conducted in accordance with established scientific principles that acute or chronic health effects may occur in exposed employees. The term “health hazard” includes materials which are carcinogens, toxic or highly toxic agents, reproductive toxins, irritants, corrosives, sensitizers, hepatotoxins, nephrotoxins, neurotoxins, agents that act on the hematopoietic systems, and agents which damage the lungs, skin, eyes, or mucous membranes. The term “physical hazard” includes materials for which there is scientifically valid evidence that it is a combustible liquid, a compressed gas, cryogenic, explosive, flammable, an organic peroxide, an oxidizer, pyrophoric, unstable (reactive), or water-reactive.

Hazard Warning: Any words, pictures, symbols, or combination thereof appearing on a label or other appropriate form of warning that convey the health and physical hazards of the substance(s) present.

Highly Toxic: A substance is considered to be highly toxic if:

- a) A substance that has a median lethal dose (LD50) of 50 milligrams or less per kilogram of body weight when administered orally to albino rats weighing between 200 and 300 grams each.
- b) A substance that has a median lethal dose (LD50) of 200 milligrams or less per kilogram of body weight when administered by continuous contact for 24 hours (or less if death occurs within 24 hours) with the bare skin of albino rabbits weighing between 2 and 3 kilograms each.

- c) A substance that has a median lethal dose (LD50) in air of 200 parts per million by volume or less of gas or vapor, or 2 milligrams per liter or less of mist, fume, or dust, when administered by continuous inhalation for one hour (or less if death occurs within one hour) to albino rats weighing between 200 and 300 grams each.

HIV/HBV Research Facility: A laboratory producing or using research laboratory scale amounts of HIV or HBV. Research laboratories may produce high concentrations of HIV or HBV but not in the volume found in production facilities.

Irritant: A substance which is not corrosive, but which causes a reversible inflammatory effect on living tissue by chemical action at the site of contact. A substance is a skin irritant if, when tested on the intact skin of albino rabbits by the methods of 16 CFR 1500.41 for 24 hours exposure by other appropriate techniques, it results in an empirical score of 5 or more. A substance is an eye irritant if so determined under the procedure listed in 16 CFR 1500.42 or other appropriate techniques.

NIH: National Institute of Health

Nonflammable Medical Gas: A compressed gas, such as oxygen or nitrous oxide, which is nonflammable and used for therapeutic purposes.

Organic Peroxide: An organic compound that contains the bivalent –O-O– structure and which may be considered to be a structural derivative of hydrogen peroxide where one or both of the hydrogen atoms has been replaced by an organic radical.

Oxidizer: A substance other than a blasting agent or explosive that initiates or promotes combustion in other materials thereby causing fire either itself or through the release of oxygen or other gases.

Pyrophoric: A substance that will ignite spontaneously in air at a temperature of 130° (54.4°C) or below.

Risk Levels:

1. **LOW RISK:** risk level of agents and/or operations having minimal effect on personnel, other animal or plants under ordinary use. This classification is restricted to all etiologic agents designated as Biosafety Level 1 by the CDC.
2. **MODERATE RISK:** risk level of agents/or operations requiring special conditions for control or contaminated because of (a) known pathogenicity to personnel, other animals or plants; (b) concentration; or (c) genetic alteration (synergistic effect) with other materials. This classification includes all etiologic agents designated as Class 2 or 3 by the CDC (Biosafety Level 2 or 3) and oncogenic viruses specified as moderate risk by the National Cancer Institute (NCI).
3. **HIGH RISK:** risk level of agents and/or operations requiring additional control measures beyond those for moderate risk. This classification includes all etiologic agents designated Class 4 or 5 by the CDC and oncogenic viruses classified as high risk by the NCI.

Sensitizer: A substance that causes a substantial proportion of exposed people or animals to develop an allergic reaction in normal tissue after repeated exposure to the substance.

Toxic: A substance is considered to be toxic if:

- a) A substance that has a median lethal dose (LD50) of more than 50 milligrams per kilogram but not more than 500 milligrams per kilogram of body weight when administered orally to albino rats weighing between 200 and 300 grams each.
- b) A substance that has a median lethal dose (LD50) of more than 200 milligrams per kilogram but not more than 1000 milligrams per kilogram of body weight when administered by continuous contact for 24 hours (or less if death occurs within 24 hours) with the bare skin of albino rabbits weighing between two and three kilograms each.
- c) A substance that has a median lethal dose (LD50) in air of more than 200 parts per million but not more than 2000 parts per million by volume of gas or vapor, or more than 2 milligrams per liter but not more than 20 milligrams per liter of mist, fume, or dust, when administered by continuous inhalation for one hour (or less if death occurs within one hour) to albino rats weighing between 200 and 300 grams each.

CCR, Title 24, Part 9, Section 221-T

Unstable (reactive): A substance which in the pure state, or as produced or transported, will vigorously polymerize, decompose, condense, or will become self-reactive under conditions or shocks, pressure or temperature.

Vapor Pressure: The pressure, measured in Pisa, exerted by a liquid.

NFPA 1

Water-reactive: A substance that reacts with water to release a gas that is either flammable or presents a health hazard.

Source:

Stanford Laboratory Standard & Design Guide
University of NC at Chapel Hill

Additional Notes:

Laboratory users and planners sometimes call for tight tolerances based on laboratory function, without evaluating whether these are actually required. Tight tolerances can increase energy use due to reheat and humidification. It is recommended that tolerances tighter than those required for human comfort (e.g., based on ASHRAE Standard 55) be carefully evaluated and explicitly justified. Standard 55 is continuously revised by addenda that are publicly reviewed, approved by ASHRAE and ANSI, and published and posted for free on the ASHRAE Web site.

All newly constructed or renovated laboratory spaces must have a third party Associated Air Balance and Certification (AABC) or National Environmental Balancing Bureau (NEBB) certified air balance performed.

SECTION 12.0c

CONSTRUCTION SYSTEMS AND ASSEMBLIES STANDARDS AND GUIDELINES

ADDENDUM C: CLASSROOMS AND AUDITORIA BEST PRACTICES

INTRODUCTION

The following list of classroom and auditorium features was compiled by Academic Program Management for use in the design of teaching space. Some of the information will duplicate information in various areas within Section 12, but is repeated here for convenience. Design consultants should review the list with the user for applicability to individual projects.

General Purpose Classroom

- Wiring/Lighting
- Master on/off light switch by every door to the classroom.
- Lights zoned parallel to whiteboard with dimming capability
- Two rows of two-scene indirect/direct luminaires mounted perpendicular to the main teaching wall (parallel to the window)
- Dedicated luminaire is used to illuminate the whiteboard on the main teaching wall and spaced 14-15' apart
- Wireless or laptop plug-in friendly room
- Data and electrical stub up instead of stretch across floor
- Prevent interference between pendant lights and data projector
- Data and electrical capacity –transformer box as needed
- Teacher control is placed at the front of the classroom. Place teacher controls within 6" of the whiteboard for easy access.
- Install technology waist-level (but wheelchair accessible) so faculty don't have to kneel down to plug in their equipment

Layout

- Line of sight
- Bench/stadium seating preferred
- Back or side hall entry
- Instructor podium walk-about area

Equipment/Furnishings (see also UH Technology Infrastructure Standards, Section

13.0. http://www.uh.edu/infotech/_documents/UHNetworkInfrastructureStandards_v01_22.pdf

Largest desk tablets (laptop friendly)

- Complete blackout curtain
- Seat #s on chairs
- Faculty table/chair – table for exam collection
- Bulletin or information boards – some place to post grades/flyers/class appropriate information, e.g. periodic tables
- Maximum length of best quality whiteboards
- Wall borders and trays for boards
- If drop down screens, large enough side panels with electronic whiteboard access
- Classroom support telephone number chart by each light switch/phone
- Post basic instruction tables for lights/sound/tech system
- Default settings on equipment – all tech set-ups identical
- Cougar1Card readers – not typically used; if requested by faculty inform that there is a cost of use associated with the readers to get usage reports; if used in large room – have enough readers located inside the room and enough to avoid bottlenecks on student traffic; for general purpose rooms, consider using maglock readers on doors for security/access control.

Other

- Rooms must be Life Safety and ADA code-compliant
- Security features protecting technology and students (see also Design Guidelines Section 12 C1025 INTERIOR DOOR HARDWARE and D5030 FIRE DETECTION AND ALARM SYSTEM)

Large Auditoria (150 seats plus) -- in addition to the general purpose classroom provisions, provide the following:

Wiring/Lighting

- Spotlights for speaker area (for official presentations)
- Lighting sufficient in all student seating areas for exams

Layout

- Back and/or side hall entry
- Break-out session rooms
- Lobby area with seating
- Seating in restrooms

Equipment/Furnishings (see also UH Technology Infrastructure Standards, Section 13.0.

http://www.uh.edu/infotech/_documents/UHNetworkInfrastructureStandards_v01_22.pdf

Option: Projection capability to record or project the speaker during the presentation on the screens (e.g. Houston room)

- Portable microphones

- Remote control for presentations (e.g. PowerPoint slides, remote advance)

Other

- Rooms must be Life Safety and ADA code-compliant
- Security features protecting technology and students

The following information was provided by the IT Classroom Technology group, which updates maintains, and issues the information as necessary. It is provided here to assist in preliminary classroom planning. Information below should be confirmed with University of Houston information Technology Classroom Technologies:

**University of Houston information Technology
Classroom Technologies
Standardized Classroom Teaching Equipment**

(See also UH Technology Infrastructure Standards, Section 13.0. http://www.uh.edu/infotech/documents/UHNetworkInfrastructureStandards_v01_22.pdf)

This information represents the current standards in the design of AV equipping for general classrooms at the University of Houston. Technology standards are intended to provide a common, consistent and user friendly environment for Faculty, Teacher Assistant and Staff.

The goal is to install reliable systems with consistent functionality and common interfaces for all classrooms.

These goals will improve technical support and system management, resulting in reduced operational costs and faster response time for maintenance issues.

Four types of classrooms are defined:

- Type 1 basic: < 50 students,
- Type 2 medium: < 100 students,
- Type 3 large: < 200 students,
- Type 4 auditorium: 200 – 600 students.

Type of Classrooms:

Type 1 (Small)

General purpose classrooms (< 50 students) have basic standard technologies such as:

Projector - Ceiling mounted projector WXGA (1024X800) with minimum 4500 lumens output is required.

Projection Screen - A manual pull down screen (16:10 ratio) Matte white mounted on the front wall above the writing surface.

Controls - Extron Media Link with IP link for Global Room View.

Audio - Amplifier, with 4 to 6 mounted ceiling speakers.

Wall Plate - Computer input 1 & 2 (Laptop, Desktop) Video input and HDMI.

Podium –

Universal Podium Lectern to include front facing standard 19” rack rails.

Locking rear access panel,

Flip up side shelf (right side).

One cable access cut in rear right corner of lectern top.

One ECA Interact with 2 power cords.

Power manager with surge protection located at the top position in the equipment rack.

3 shelves lectern.

Custom rack shelf for Computer, DVD or Blu Ray,

Empty slots covered with plan face plates

All rack mounted items are to be fastened with security screws.

Multimedia Cables- Conduit for all cables such as: Power, VGA, HDMI, Network,

Video/Audio cables from Wall Plate to the Podium. Plenum rated cabling may be substituted as required.

Network - 3 Network RJ45 jacks (desk top, laptop computers and room view management).

Electrical - Electrical outlet to be installed close to the data wall plate, near the podium. AC power with quad plugs provided above the ceiling for Extron controls and projector.

Equipment to be installed in the Podium.

The following equipment is to be installed in house by Classroom Technologies group.

Desk Top Computer

DVD – (Regions Free)

Type 2 (Medium)

General purpose classrooms (< 100 students) have basic standard technologies such

as:

Projector - Ceiling mounted projector WUXGA (1920X1200) with minimum 5000 lumens output required.

Projection Screen - Power screen (16:9 ratio) Matte White mounted in front wall above writing surface.

Smart Sympodium - Device allows student to see anything that written on the presenters computer screen using a special pen and monitor.

Wall Plate – Same as GPC plus RCA audio & video in/output for recording.

And all of the items described in Type 1.

Type 3 (Large)

General purpose classroom (< 200 students) has basic standard technologies such as:

Projectors (Dual) - Ceiling mounted projectors WUXGA (1920X1200) with minimum 5000 lumens output required.

Projection Screen (Dual) - Power Screens (16:9 ratio) Matte White is mounted in front wall above writing surface.

Crestron Touch Screen Control - Control lighting, power screen, and audio etc.

Audio - Amplifier, Wireless Audio Receiver and Transmitter (microphone) with 6 to 8 mounted ceiling speakers.

Document Camera (Optional)- displays objects or documents through projector.

Teleconference & Mediasite – Room to be pre-wired and programmed into the Crestron Controls.

Wall Plate – Same as GPC plus RCA audio & video in/output for recording.

And all of the items described in Type 1.

Type 4 (Auditorium)

General purpose classroom (200-600 students), It has basic standard technologies

such as:

Projector - XGA (1024X768) projector with a minimum of 7000 to 12000 Lumens output required.

Projection Screen - Power Screens (16:9 ratio) Matte White mounted in front wall above writing surface.

Crestron Touch Screen Control - Control lighting, power screen, and audio etc.

Audio - Amplifier, Wireless Audio Receiver and Transmitter (microphone) with 8 to 12 mounted ceiling speakers.

Document Camera (Optional) - displays objects or documents through projector.

Smart Symposium - Device allows student to see anything written on the presenters computer screen using a special pen and monitor.

Teleconference & Mediasite - Room to be pre-wired and programmed into the Crestron Controls

Wall Plate – Same as GPC plus RCA audio & video in/output for recording.

And all of the items described in Type 1.

NOTES

Audio: Number of speaker, it depends on the type of seating, room configuration.

Controls: Future room view management from remote sites. All operation controls shall be ADA compliant.

Projector: Multiple projectors may be required, depending on the type of seating, room configuration.

Projection Screen: Multiple screens may be required, depending on the type of seating, room configuration and instruction style.

Wall Plate: To be installed in front of classroom, opposite side of door entry, toward the corner.

Podium: Size of the podium depends on the type of seating, room configuration. All operate controls on the podiums are placed within ADA compliance.

SECTION 12.0d

CONSTRUCTION SYSTEMS AND ASSEMBLIES STANDARDS AND GUIDELINES

ADDENDUM D: Alarm and Special Hazard Protection Specifications Sections Included:

**SECTION 5.21.00 – FIRE SUPPRESSION
SECTION 5.21.10 – WATER-BASED FIRE-SUPPRESSION SYSTEMS
SECTION 5.28.30 – ELECTRONIC DETECTION AND ALARM
SECTION 5.28.30 – ELECTRONIC DETECTION AND ALARM**

SECTION 5.21.00 – FIRE SUPPRESSION

PART 1 GENERAL

1.01 Scope of Standard

A. The design guidelines contained herein include the requirements for systems, materials, fittings, and valves utilized for fire protection systems at The University of Houston. It is the intention of this document to provide a minimum standard for fire protection materials, fittings, and valves at the University so as to provide the highest level of fire safety possible. This document is not intended to be a guide specification.

1.02 Scope of Work

A. Reference Standards (Utilize latest editions available):

1. NFPA 13-Standard for the Installation of Sprinkler Systems.
2. NFPA 13R-Standard for the Installation of Sprinkler Systems in Low-Rise Residential Occupancies
3. NFPA 14-Standard for the Installation of Standpipe and Hose Systems.
4. NFPA 24-Standard for the Installation of Private Fire Service Mains and their Appurtenances
5. NFPA 25-Standard for the Inspection, Testing, and Maintenance of Water Based Fire Protection Systems.

1.03 Related Work: References/Quality Assurance

A. The University of Houston, International Building Code, National Fire Codes as published by the National Fire Protection Association (NFPA), State Fire Marshal,

and the University of Houston Fire Marshal's requirements contain fire protection criteria and requirements for the installation of all fire suppression systems. The contractor shall conform to the following:

1. All materials and performance shall meet the appropriate ANSI, ASME, and ASTM Codes.
 2. Welding Materials and Procedures shall conform to the ASME Code.
 3. Only welders certified in accordance with ANSI/ASME Section 9 shall be employed.
- B. Each item of equipment shall be new and listed by Underwriters Laboratories (UL) or approved by FM Global. Each major item of equipment shall bear the manufacturer's name or trademark; serial number, and UL or FM label.
- C. Submittals:
1. The University of Houston Project Manager shall review and distribute all submittals including drawings, calculations, and material data for approval by the University of Houston, the U of H Fire Marshal, the Owner representative, and others as appropriate.
- D. Refer to provisions established in the Project Specifications and in related section of Division 01 – General Requirements. All product data shall be submitted under provisions of Division 01.
- E. Manufacturer's data sheets shall be provided for all materials and equipment for approval before purchase or installation. Data sheets shall describe the type of material, capacities, manufacturer, and part numbers of equipment and give information necessary for verifying equipment approval.

PART 2 PRODUCTS

2.01 Pipe

- A. Aboveground Pipe
1. All wet sprinkler system piping shall be a minimum of schedule 40 black steel with threaded fittings for sizes 2 inches and smaller, and black schedule 40 steel with grooved fittings for sizes larger than 2 inches. All dry and preaction system piping and fittings are required to be externally and internally galvanized.
 2. CPVC piping listed for use in fire sprinkler systems may be utilized where installed in accordance with UL listing. CPVC piping may only be installed in residential occupancies and structures up to and including four stories in height when the piping is installed and protected in accordance with the manufacturer's listed requirements. Provide CPVC fittings that listed with the CPVC piping being utilized.

3. Piping shall be concealed above suspended ceilings where installed, in a craftsman like manner, and shall not interfere in the complete function of other systems such as cable trays, access panels, or pedestrian passageways. Piping in all occupied areas and mechanical area passageways shall not be lower than 7'-6". Specific written approval may be granted for unavoidable projections, but under no circumstances shall overhead piping be installed lower than 6'-8" above the floor. Piping shall not reduce the required width of any means of egress, width of stairs, or clear width of corridor or passageway, to less than 44 inches in width. Installation of all piping shall be in coordination with piping ducts, light fixtures, and any other work that may obstruct sprinklers. The contractor shall coordinate with all trades having materials installed above the ceiling prior to commencement of any work.
4. Piping that is retrofit into an existing building with suspended ceilings shall be installed above the existing ceiling, unless exposed piping is approved by the University.
5. All exposed sprinkler and standpipe systems located in areas without suspended ceilings is are required to be painted. Prepare galvanized pipe as necessary, such as priming, prior to painting pipe. Coordinate color of pipe with the University. All pipe, whether concealed or exposed, is required to be marked "Fire Sprinkler System" with markers spaced at 10 foot intervals with red (or a contrasting color if pipe is painted red) letters at a minimum of 1 inch in height.

B. Underground Pipe:

1. Each underground pipe joint or connection shall include a compression-type joint restraint device (Mega Lug or equal). Any changes in direction of underground piping shall be provided with a thrust block or joint restraint as required per NFPA 13 and NFPA 24. Changes in direction where entering buildings shall be provided with both thrust blocks and joint restraints.
2. Underground pipe shall be installed by a fire sprinkler contractor licensed by the State of Texas or a Texas State licensed plumbing company holding a Registered Managing Employee - General (RME-G) certification from the Texas State Fire Marshal's Office to install underground fire service mains.
3. All underground pipe connection sprinkler and standpipe systems to the campus Fire Water Distribution System (FWDS) shall be rated for the maximum churn, or no flow pressure, of the largest fire pump in the FWDS zone plus the maximum static pressure at the suction side of the FWDS fire pump. Pipe shall be hydrostatically tested for two hours at the highest static pressure rating plus 50 psi, or 200 psi, whichever is greater per NFPA 24.

2.02 Mechanical Grooved Couplings

- A. When grooved couplings are used, rolled-grooved joints are required with fittings and couplings designed for a working pressure of 300 psi. Malleable iron housing clamps: ASTM A47; UL labeled; engage and lock, designed to permit some angular deflection, contraction, and expansion (Firelock fittings acceptable).
- B. Galvanized couplings are required for galvanized pipe.
- C. “C” shaped composition sealing gasket: ASTM D2000
- D. Steel bolts, nuts, and washers: ASTM A183 heat treated with minimum tensile strength of 110,000 psi.

2.03 Valves

- A. Unless specified otherwise, all valves shall be UL listed or FM approved and be suitable for the maximum anticipated system pressure or a minimum of 175 psi working pressure, whichever is greater.
- B. All valves in the sprinkler system shall be UL listed Outside Screw & Yoke (O.S.&Y.) type indicating valves. The use of any other type of indicating valve must first be approved by the U of H Fire Marshal.
- C. All O.S.&Y. valves shall have a built in tamper resistant switch for supervision of the open position. The switch shall be contained within a NEMA Type 1, general purpose indoor rated housing. Either unauthorized removal of the switch housing (when the valve is open) or closing the valve, shall cause the switch contacts to change position. The switch shall have four conductors to accommodate connections to Style 4 or Style 6 signaling line circuit devices.
- D. Where O.S.&Y indicating valves are installed, the following shall apply:
 - 1. Valves 2-1/2 inches and larger shall be iron body with brass seats, discs, and stems. Include tamper switches listed for use with OS&Y valves.
 - 2. Valves 2 inches and smaller shall be brass body, stem, and seat. Include tamper switches listed for use with OS&Y valves.
- E. Check valves shall comply with the following:
 - 1. Check valves 2-1/2 inches and larger shall be iron body swing check with cast brass hinge, rod and brass faced discs.
 - 2. Check valves 2 inches and smaller shall be UL listed brass body and all brass fitted.
- F. Ball valves shall be constructed of forged brass with Teflon seats and shall be provided with a vinyl-covered handle.
- G. Post Indicator Valve

1. Gate valve on incoming water service shall be operable by a UL listed post indicator valve with tamper switch monitored by the associated building fire alarm panel.
- H. All valves controlling water supply for sprinklers shall be readily accessible for use by emergency and maintenance personnel.
- I. Except for underground water supply valves located in roadway boxes, all valves controlling water supply to sprinklers shall be supervised by the fire alarm system.
- J. A control valve shall be installed at the base of each riser. Locate standpipe isolation control valves within the stair enclosure and exposed for maintenance purposes.
- K. Sprinkler systems shall have a minimum of one floor control valve installed on every floor.
- L. Pressure reducing valve:
 1. Sprinkler systems connected to the campus FWDS or new fire pump system are required to be provided with a pressure reducing valve. The pressure reducing valve shall be installed in a location that does not reduce pressures on the building standpipe system, if provided.

2.04 Piping Accessories

- A. All hanger components other than all thread shall be UL listed or FM approved. No sprinkler piping is to be supported from any mechanical or electrical devices and/or equipment (ducts, lights, etc.). Hanger assemblies installed outside, or otherwise exposed to weather, shall be externally galvanized.
- B. Provide sleeves where pipes penetrate beams, floors, or walls and install prior to construction of walls or pouring of concrete. Install sleeves flush with all surfaces.
- C. Sleeves for underground pipe shall have mechanical rubber seals and be watertight.
- D. Floor, wall, and ceiling plates shall be pressed steel or cast iron split plates, chromium plated.
- E. Pressure gauges shall be UL listed or FM approved for fire service.

2.05 Identification Tags

- A. Identification signs shall be porcelain enameled 18 gauge and shall be affixed securely by brass chain to all valves. The signs shall be red in color.

- B. Provide an approved laminated valve chart in frame and Plexiglas cover showing location and use of each valve. The chart shall be secured in a visible location acceptable to the University near the system riser.
- C. The main drain sign shall be labeled “MAIN DRAIN”. Riser drains shall be labeled “RISER DRAIN” or “DRAIN”.
- D. Auxiliary drain signs shall be labeled “AUXILIARY DRAIN”.
- E. Inspector’s test connection signs shall be labeled “INSPECTOR’S TEST”.
- F. All water supply control valves shall have a standard sign identifying the portion of the system controlled, noting that the valve shall be kept open, and leaving a blank space for notification information.
- G. All isolation valves shall be marked on identification tag whether valve is to be “normally open” (NO) or “normally closed” (NC).

2.06 Drains and Test Piping

- A. All portions of the system shall be equipped with drains of the size specified in NFPA 13. Design sprinkler system that will drain to the riser. All drains, including auxiliary drains, shall be piped to the sanitary sewer system or other approved location.
- B. Every water flow switch shall have an inspector’s test connection located downstream and piped to the sanitary sewer system.

2.07 Backflow Preventer

- A. A double check backflow prevention assembly shall be installed prior to any sprinkler or standpipe system connected to the City of Houston water distribution system, including connection of pressure maintenance pumps to the building’s domestic water line utilized to fill sprinkler system piping. Backflow preventers are not required for fire sprinkler and standpipe piping connected directly to the campus FWDS.

2.08 Fire Sprinkler Standard:

- A. A remote express drain line is required for all building with floor control assemblies in addition to the main / inspectors test drain. This drain line shall be installed in the remote stairwell from the supply standpipe. The drain line shall be piped to a sanitary sewer or other approved location.

PART 3 EXECUTION

3.01 Guarantee

- A. The Contractor shall guarantee and service all workmanship and materials to be as represented by him, and shall repair or replace, at no additional cost to the Owner, any part thereof, which may become defective within the period of one (1) year after the date of final acceptance by the Engineer, ordinary wear and tear expected. Contractor shall be responsible for, and pay for, any damages caused by, or resulting from defects in his work.

3.02 Qualifications

- A. System design and installation shall be supervised by a licensed NICET Level III sprinkler system technician or fire protection engineer with not less than five (5) years of experience with sprinkler systems. Accurate As-Built drawings shall be required in the form of three hard copies and two copies on CD in the specified format. The signature of the RME or engineer constitutes an affidavit that the statements, representations, and information presented in the submittal constitute a complete operational system conforming to applicable state laws and recognized good engineering practices. All field installation work shall be continuously supervised by a NICET Level II or III sprinkler system technician.

3.03 System Acceptance Testing and Commissioning

- A. Perform acceptance tests according to NFPA 13, NFPA 13R, NFPA 14, and NFPA 24. Acceptance tests shall be witnessed by UH Fire Marshal. Provide copies of State test reports to the U of H Fire Marshal, FP&C Services, and other interested parties as tests are completed. Provide a complete set including all tests results to the Owner at the completion of the project and a copy in each O&M Manual.

END OF SECTION 5.21.00 – FIRE SUPPRESSION

SECTION 5.21.10 – WATER-BASED FIRE-SUPPRESSION SYSTEMS

PART 1 GENERAL

1.01 Scope of Standard

- A. This standard provides general requirements of the University of Houston for combination automatic sprinkler/standpipe, automatic fire sprinkler, and standpipe systems. This document is not intended to serve as a guide specification.
- B. The design guidelines contained herein include the requirements for fire protection systems at the University of Houston. It is the intention of this document to provide a minimum standard for fire protection systems at the University so as to provide the highest level of fire safety possible.

1.02 Scope of Work

- A. Provide all design and material required to provide a complete fire protection system to protect the specified building in accordance with design requirements. Antifreeze loops are not permitted. The preference of the University is to connect to the campus Fire Water Distribution System (FWDS) provide code compliant combination wet automatic fire sprinkler and where possible, automatic standpipe systems that do not contain alarm valves or local alarm devices, and a minimum 10-psi or 10% safety factor, whichever is greater, without requiring a building fire pump.
- B. Provide a complete automatic sprinkler system as defined by the latest edition of NFPA 13. All fire sprinkler systems installed on campus are required to be wet pipe systems unless the area being protected cannot be maintained above 40 degrees F, as required per NFPA 13. These areas will require a dry pipe system to be installed. Antifreeze systems of any size are not permitted on campus. Rooms or areas where it is not desirable to have water filled piping within the room, such as special collections, computer rooms, etc. may utilize double interlock preaction systems. Use of preaction systems must be approved by the University prior to system design.
- C. Standpipe systems must be installed where required by NFPA 101 or the latest edition of the International Building Code. All standpipe systems shall be Class I in all cases, regardless of minimum code requirements, and designed per the latest edition of NFPA 14. 2-1/2" hose valves are required at the intermediate stair landing of all stairs and a separate fire sprinkler riser located in one main stair landing. Provide standpipe isolation control valves with tamper switches for each standpipe as required per NFPA 14. Locate isolation control valves within the stair enclosure and exposed for maintenance purposes.
- D. The work addressed in this section consists of a fire protection system, which may include coordination with one or more of the following:

1. Fire Alarm Systems
2. HVAC and smoke control systems and fire smoke, and combination fire/smoke dampers.
3. Emergency power systems.
4. Elevator installation. See the Texas State Elevator Code ASME/ANSI A17. 1 and ASME/ANSI A17.3.
5. Central control and monitoring system.

E. Reference Standards (Utilize latest editions available):

1. NFPA 13- Standard for the Installation of Sprinkler Systems.
2. NFPA 13R-Standard for the Installation of Sprinkler Systems in Low-Rise Residential Occupancies
3. NFPA 14- Standard for the Installation of Standpipe and Hose Systems.
4. NFPA 24- Standard for the Installation of Private Fire Service Mains and their Appurtenances.
5. NFPA 25-Standard for the Inspection, Testing, and Maintenance of Water Based Fire Protection Systems.
6. NFPA 101-Life Safety Code.
7. IBC-International Building Code.

1.03 Related Work: References/Quality Assurance

- A. The University, the International Building Code, National Fire Codes as published by the National Fire Protection Association (NFPA), State Fire Marshal, and the University of Houston Fire Marshal's requirements contain fire protection criteria and requirements for the design of all fire suppression systems. The project shall conform to the following:
- B. Conform to a minimum of the latest edition of NFPA 13 for sprinkler systems. Insurer may require design in excess of NFPA 13.
- C. Conform to a minimum of the latest edition of NFPA 14 for standpipe systems. Insurer may require design in excess of NFPA 14.

1.04 Submittals

- A. The University of Houston Project Manager shall review and distribute all submittals for approval by the University insurer, the U of H Fire Marshal, the Owner's representative, and others as appropriate.
- B. Refer to provisions established in the Project Specifications and in related section of Division 01 – General Requirements. All product data shall be submitted under provisions of Division 01.
- C. Manufacturer's data sheets shall be provided for all materials and equipment for approval before purchase or installation. Data sheets shall describe the type of material, capacities, manufacturer, part numbers of equipment, and give information necessary for verifying equipment approval.
- D. The Contractor shall submit detailed and accurate shop drawings prepared in accordance with NFPA 13, NFPA 14 (if applicable), and NFPA 24 for approval of all equipment to be constructed and installed. Shop drawings shall identify all materials and list all equipment to be used. Shop drawings shall include ceiling grid or reflected ceiling layout and shall be coordinated with other trades prior to submittal.
- E. Hydraulic calculations for sprinkler systems shall comply with NFPA 13 and shall include comprehensive hydraulic data sheets. Provide a 10 psi or 10% safety factor, whichever is greater, for all sprinkler system hydraulic calculations.
- F. Provide hydraulic calculations for automatic standpipes, where required per NFPA 14, to provide 100 psi when flowing 500 gpm at the most remote standpipe outlet and 250 gpm at each additional standpipe. Provide hydraulic calculations for manual standpipes to demonstrate the pressure available at the top of each standpipe while flowing, the demand required per NFPA 14 utilizing both the available water supply and the nominal City of Houston fire truck pumper through the fire department connection.
- G. Prior to preparing shop drawings and hydraulic calculations, the design engineer is required to verify the adequacy of the water pressure and other pertinent water supply data from either the campus Fire Water Distribution System (FWDS) or the City of Houston water distribution system, depending on which system will be utilized to supply the new sprinkler and/or standpipe system. Hydrant flow tests performed on the University distribution system shall incorporate erosion control requirements in this standard. See 2.10L Field Acceptance. The design engineer shall immediately notify the U of H Fire Marshal and Project Manager of the need for testing the appropriate water supply or fire pump, or the need for any special considerations required. The U of H Fire Marshal shall witness all flow tests. The engineer shall provide the record data at the point of the new utility connection as follows:
 - 1. Building Name and flange elevation (ft)
 - 2. Test Hydrants (hydrant numbers and location) and hydrant elevations (ft)
 - 3. Flow rate (gpm), static pressure (psi), and residual pressure (psi)

- H. No work shall be performed until the University has approved the shop drawings, calculations, and data sheets. The Contractor is solely liable for any work performed prior to this approval.

PART 2 PRODUCTS

2.01 Piping and Fittings

- A. Refer to Section 5.21.00

2.02 Valves

- A. Refer to Section 5.21.00

2.03 Sprinklers

- A. Sprinklers shall be listed or FM approved and shall not include O-rings seals. Any sprinkler that incurs damage, is painted, or is sprayed with any obstructive material during construction shall be replaced at no cost to the University. Installation of sprinklers shall be coordinated with other work, including duct and electric fixture installation, to prevent sprinkler obstructions.
- B. Sprinklers located less than eight feet above finished floor or that may be subject to mechanical damage shall be provided with guards listed for use with the model of sprinkler installed.
- C. Quick-response sprinklers are required throughout all light-hazard occupancies, and laboratory units and may also be installed in ordinary-hazard occupancies for the quick-response hydraulic design area reduction per NFPA 13 for utilizing quick-response sprinklers. Extended coverage sprinklers may be utilized if proven in the hydraulic calculations.
- D. Unless specific aesthetic appearance is required for the project, white or chrome recessed pendent sprinklers with matching escutcheons shall be provided in areas with suspended ceilings, and brass upright sprinklers shall be provided in areas without suspended ceilings. Verify with the U of H Project Manager prior to specifying sprinkler type and finish.
- E. Where required by the project, sprinklers shall be centered in two directions in ceiling tiles. Pendent sprinklers required to be placed in the center of ceiling tiles, shall be supplied from a return bend that connects to an outlet at the top of the fire sprinkler branch line piping.
- F. Main electrical equipment rooms may have alternate protection such as a pre-action, dry sprinkler systems or chemical suppression system. Approval must be sought by appropriate department in cooperation with the UH Fire Marshal's Office.

2.04 Drains and Test Piping

- A. All trapped portions of the system shall be equipped with drains of the size specified in NFPA 13. Where possible, design a system that will completely drain to the system riser. Where any trapped water exists, provide an auxiliary drain per NFPA 13 and pipe to the sanitary sewer system or other acceptable location.
- B. Every water flow switch shall have an inspector's test connection located downstream of the water flow switch and piped to the sanitary sewer system or other acceptable location.

2.05 Dry Pipe System

- A. Dry pipe systems shall only be installed where the area being protected cannot be maintained above 40 degrees F, as required per NFPA 13.
- B. In areas subject to freezing that cannot be protected by dry type sprinklers on a wet sprinkler system, a dry pipe system shall be installed. Antifreeze loops are not permitted.
- C. Pitch dry pipe system piping a minimum of 1/4-inch per 10 feet for dry system mains and minimum of 1/2-inch per 10 feet for dry system branch lines.
- D. Provide full length dry pendent sprinklers that connect directly to the dry system branch line tee fittings in areas with suspended ceilings. Do not install dry pendent sprinklers on drops.
- E. Provide a tank or riser-mounted air compressor listed for fire protection use and sized to refill the entire dry pipe system within 30 minutes as required per NFPA 13.
- F. Utilize an air maintenance device and supervisory air pressure switch to maintain and monitor the dry pipe system air pressure.

2.06 Pre-action Sprinkler System

- A. Provide a double interlock pre-action system where the University prefers to eliminate water filled piping within the room, such as special collections, etc.
- B. Pitch pre-action system piping a minimum of 1/4-inch per 10 feet for pre-action system mains and minimum of 1/2-inch per 10 feet for pre-action system branch lines.
- C. Provide full length dry pendent sprinklers than connect directly to the pre-action system branch line tee fittings in areas with suspended ceilings. Do not install dry pendent sprinklers on drops.

- D. Provide a tank or riser-mounted air compressor listed for fire protection use and sized to refill the entire pre-action system within 30 minutes as required per NFPA 13.
- E. Utilize an air maintenance device and supervisory air pressure switch to maintain and monitor pre-action system air pressure.
- F. Requirements for detection, pre-action system releasing, pre-action system monitoring, and the pre-action release control panel are noted in Section 28.30.00.

2.07 Standpipe Systems

- A. Where a standpipe system is required to be installed, the standpipe shall be designed as Class I, manual-wet or automatic-wet standpipe as required by NFPA 14 and the IBC.
- B. Where a standpipe system is required in a building or area where the temperature cannot be maintained above 40 degrees F at all times, a dry standpipe is required to be installed. Dry standpipe systems installed on campus shall be Class I, manual-dry standpipes as defined by NFPA 14. Provide galvanized pipe, fittings, and hangers for all dry standpipe systems.
- C. Each standpipe shall be installed with a UL listed 2-1/2 inch NST fire department hose connection with caps and located in the intermediate stairwell landing with caps hose valves on each floor. Where the distance between the stairwells exceeds the criteria indicated in NFPA 14, provide additional hose valves locations. Locate the additional hose valves in UL listed recessed valve cabinets utilizing only 2-1/2" hose valves without the hose.
- D. Provide standpipe isolation control valves supervised by the fire alarm system as required per NFPA 14. Locate standpipe isolation valves within stairwells and exposed, unless an alternate location has been approved by the University.
- E. Each standpipe shall have a drain sized and located in accordance with NFPA 14. Each drain shall be discharged to sanitary sewer or other acceptable location.
- F. All dry standpipe system piping shall be installed so that the entire system may be drained back to the system riser. Where building conditions do not allow complete system drainage, provide auxiliary drains for all trapped sections of pipe in accordance with NFPA 13. The number of auxiliary drains shall be kept to a minimum.
- G. Each dry standpipe shall be provided with an air and vacuum valve installed at the top of each riser. The air and vacuum valve shall be 1 inch APCO Series 140 air and vacuum valve, manufactured by Valve and Primer Corporation or approved equal.

- H. Where required, a conveniently accessible two-way hose connection shall be provided at the roof level. If the building layout and construction permits, penetrations for the roof level hose connection shall be through an exterior wall and not through the roof.
- I. Manual-wet standpipe systems calculated utilizing the responding fire department pumper truck for the required pressure and flow per NFPA 14 shall be tested utilizing the pumper truck to prove the hydraulic calculations submitted during design.
- J. Where a combination sprinkler/standpipe is provided, the floor control assembly supplying the sprinkler system is required to have a check valve per NFPA 14.

2.08 Fire Department Connections

- A. Each fire department connection shall be flush wall-mounted type. Freestanding type fire department connections shall only be installed when approved by the University. Each fire department connection shall consist of a minimum of two 2-1/2 inch inlets compatible with equipment utilized by the City of Houston Fire Department and equipped with UL listed caps approved for use by the City of Houston Fire Department. The fire department connection shall be labeled to indicate the type of system served with raised letters at least one inch in size and cast on the escutcheon plate provided. The fire department connection shall not be less than two feet and not more than 3 feet 6 inches in elevation, measured from the ground level to the centerline of the inlets.

PART 3 EXECUTION

3.01 Guarantee

- A. The Contractor shall guarantee and service all workmanship and materials to be as represented by him, and shall repair or replace, at no additional cost to the Owner, any part thereof, which may become defective within the period of one (1) year after the date of final acceptance by the Engineer and U of H Contractor shall be responsible for, and pay for, any damages caused by, or resulting from defects in his work.

3.02 Qualifications

- A. System design and installation shall be supervised by a licensed NICET Level III sprinkler system technician or fire protection engineer with not less than five (5) years experience with sprinkler systems. Accurate As-Built drawings shall be required in the form of three hard copies and two copies of CD in the specified format. The signature of the RME or engineer constitutes an affidavit that the statements, representations, and information presented in the submittal constitute a complete operational system conforming to applicable state laws and recognized

good engineering practices. All field installation work shall be continuously supervised by a NICET Level II or III sprinkler system technician.

3.03 Microbiological Influenced Corrosion (MIC)

- A. Provide testing on the City of Houston water supply or the campus FWDS, whichever will be supplying the new sprinkler and/or standpipe system, in accordance with the University for MIC testing procedures.
- B. Utilize methods and procedures for flushing sprinkler and standpipe piping as required by U of H for MIC testing.

3.03 System Acceptance Testing and Commissioning

- A. Perform acceptance tests according to NFPA 13 and U of H Guidelines that apply to fire sprinkler system testing with a representative of U of H Fire Marshal's Office present. Provide copies of State test reports to the U of H Fire Marshal as tests are completed. Provide a complete set of all test results to the University at the completion of the project and a copy in each O&M Manual.

END OF SECTION 5.21.10 – WATER-BASED FIRE-SUPPRESSION SYSTEMS

SECTION 5.21.20 – Special Hazard Fire Extinguishing Systems

PART 1 GENERAL

1.01 Scope of Standard

- A This standard provides general requirements of the University of Houston for fire extinguishing systems other than water based fire suppression systems. This document is not intended to serve as a guide specification.
- B The design guidelines contained herein include the requirements for fire extinguishing systems at the University of Houston. It is the intention of this document to provide a minimum standard for the installation of fire extinguishing systems at the University so as to provide the highest level of fire safety possible.

1.02 Scope of Work

- A Provide clean agent suppression systems when the project contains an area or room with sensitive equipment or contents, and the University requires a clean agent system to activate prior to the required water based sprinkler system.
- B Provide wet or dry chemical suppression systems where required by the International Building Code, FM Global (FM), NFPA 101 or University requirements. Extinguishing systems protecting cooking appliances, hoods, and branch exhaust ducts are required to be wet chemical extinguishing systems as required by the University.
- C The work addressed in this section consists of non water based fire extinguishing systems which will be coordinated with all of the following:
 - (1) Fire Alarm Systems
 - (2) Emergency Power Systems
 - (3) Central Control and Monitoring System
- D Reference Standards (Utilize latest editions available):
 - (1) NFPA 17 Standard on Dry Chemical Extinguishing Systems
 - (2) NFPA 17A Standard for Wet Chemical Extinguishing Systems
 - (3) NFPA 2001 Standard on Clean Agent Extinguishing Systems
 - (4) UL 300 Fire Testing of Fire Extinguishing Systems for Protection of Restaurant Cooking Areas

1.03 Related Work: References/Quality Assurance

- A FM Global (FM), International Building Code, National Fire Codes as published by the National Fire Protection Association (NFPA) and the University of Houston Fire Marshal's requirements contain fire protection criteria and requirements for the design of all fire suppression systems. The project shall conform to following:
- (1) Conform to a minimum of the latest edition of NFPA 2001 for clean agent systems, NFPA 17A for wet chemical suppression systems, and NFPA 17 for dry chemical suppression systems. U of H Fire Marshal may require design in excess of NFPA requirements.
 - (2) All design shall conform to requirements of FM.

1.04 Submittals

- A The University of Houston Project Manager shall review and distribute all submittals for approval by FM, the U of H Fire Marshal, the Owner representative, and others as appropriate.
- B Refer to provisions established in the Project Specifications and in related section of Division 01 – General Requirements. All product data shall be submitted under provisions of Division 01.
- C Manufacturer's data sheets shall be provided for all materials and equipment for approval before purchase or installation. Data sheets shall describe the type of material, capacities, manufacturer, and part numbers of equipment and give information necessary for verifying equipment approval.
- D The Contractor shall submit detailed and accurate shop drawings prepared in accordance with NFPA 17 and NFPA 17A for wet and dry chemical systems for approval of all equipment to be constructed and installed. Shop drawings shall identify all materials and list all equipment to be used. Shop drawings shall be coordinated with other trades prior to submittal.
- E The Contractor shall submit detailed and accurate shop drawings and calculations prepared in accordance with NFPA 2001 for clean agent systems for approval of all equipment to be constructed and installed as follows:
- (1) Submit shop drawings and flow calculations from a UL listed computer program to the U of H Fire Marshal for approval. Total agent discharge time must be shown and detailed by zone.
 - (2) Include data for each piece of equipment comprising the system including cylinders, manifolds, control panel, and nozzles. Include product data and design calculations bearing stamp of approval of the University. Include calculations

that verify system pressures, nozzle flow rate, orifice size, node numbers, piping pressure losses, component flow data and pipe sizes.

- (3) Include manufacturer's certificate that system meets or exceeds specified requirements and NFPA 2001.
 - (4) Include welder's certificate of compliance with ASME SEC 9.
 - (5) Include manufacturer's installation instructions.
 - (6) Indicate detailed pipe layout, hangars and supports, components and accessories.
 - (7) Project Record Documents: Accurately record exact location of equipment, equipment identification markings, conduit and piping routing details and agent storage positions.
- F No work shall be performed until the University of Houston Fire Marshal's Office has approved the shop drawings, calculations, and data sheets for the new system. The contractor is solely liable for any work performed prior to this approval.

PART 2 PRODUCTS

2.01 Clean Agent Systems

- A Pipe: Black Steel Pipe: ASTM A53 seamless or electric resistance welded. Grades A or B, with internal working pressure equal to the maximum pressure of the clean agent being utilized. ASTM A 120 or ASTM A 53 Class "F" shall not be used.
- B Pipe joints and Fittings: In accordance with NFPA 2001 for clean agent system being utilized and compatible with piping. Roll groove fittings must be approved by the manufacturer for use with the clean agent system.
- C Pipe Hangers: ASME B31.1, UL or FM approved for sprinkler systems, split clamp up to 2-1/2 inch size, riser clamps over 2-1/2 inch size, adequate for offset or discharge thrust.
- D Escutcheons: Chrome plated pressed or stamped brass, one piece or split pattern, minimum 2-inches larger than opening.
- E Gauges: ASME B40.1, UL 393, and UL 404, 3-1/2 inch diameter cast aluminum case, phosphor bronze bourdon tube, rotary brass movement, brass socket, front recalibration adjustment, black figures on white background, one percent midscale accuracy, scale calibrate in pounds per square inch.

2.02 Wet and Dry Chemical Extinguishing Systems

- A Provide wet chemical extinguishing systems in accordance with NFPA 17A. Where the wet chemical extinguishing system is protecting cooking appliances, hoods, and branch exhaust ducts, the system shall comply with UL 300, *Fire Testing of Fire Extinguishing Systems for Protection of Restaurant Cooking Areas*.
- B Provide dry chemical extinguishing systems in accordance with NFPA 17. Utilize discharge nozzles, manual actuators, shutoff devices, pipe, and fittings in accordance with NFPA 17 and manufacturer's requirements.
- C Shut down all sources of fuel and electrical power to all cooking equipment producing heat upon system activation as required per NFPA 17 and NFPA 17A.
- D Monitor wet and dry chemical extinguishing systems with building fire alarm system.

PART 3 EXECUTION

3.01 Guarantee

- A The Contractor shall guarantee and service all workmanship and materials to be as represented by him, and shall repair or replace, at no additional cost to the Owner, any part thereof, which may become defective within the period of one (1) year after the date of final acceptance by the Engineer, ordinary wear and tear excepted. Contractor shall be responsible for, and pay for, any damages caused by, or resulting from defects in his work.

3.02 Qualifications

- A System design and installation shall be supervised by licensed NICET Level III sprinkler system technician or fire protection engineer with not less than five (5) years experience with sprinkler systems. Shop drawings shall be prepared and engineered. Accurate As-Built drawings shall be required in the form of three hard copies and two copies on CD in the specified format. The signature of the RME or engineer constitutes an affidavit that the statements, representations, and information presented in the submittal constitute a complete operational system conforming to applicable state laws and recognized good engineering practices. All field installation work shall be continuously supervised by a NICET Level II or III sprinkler technician.

3.03 Clean Agent Systems Testing

- A Pressure test the entire enclosure with test fan procedures per NFPA 2001, pressurizing protected area both under positive and negative conditions. Confirm that leakage is within system design allowance with a temperature of 70 degrees F. Provide any required follow up tests at no cost to the Owner.
- B Test distribution piping and valves, prior to nozzle installation, to 40 pounds per square inch air pressure test, shut valves and compressor. Inspect joints using soap

water solution or halide torch or lamp. Maintain minimum test pressure for at least 10 minutes. If pressure drops more than 20 percent during test, repair leaks and retest.

- C Upon completion of installation provide final checkout inspection by factory-trained representative of manufacturer to ascertain proper system operation. Leave system in a fully commissioned and automatic readiness state with circuitry energized and supervised.
- D Conduct a room pressurization test in each protected space to determine the presence of openings that could affect the agent concentration level. Testing must be in accordance with NFPA 2001. If room pressurization testing indicates openings exist that would result in leaks or loss of extinguishing agent, coordinate the proper sealing of the protected space as necessary until a successful room pressurization test is achieved. Submit copies of successful test results to Owner. Upon acceptance, the complete system may be placed into service.
- E Submit original copies of tests, indicating that factory trained technical representatives of the manufacturer have inspected and tested systems and are satisfied with methods of installation, connections and operation.

3.04 Wet and Dry Chemical Extinguishing Testing

- A Wet chemical systems shall be tested in accordance with NFPA 17A, and dry chemical systems shall be tested in accordance with NFPA 17.
- B Submit original copies of tests, indicating that factory trained technical representatives of the manufacturer have inspected and tested systems and are satisfied with methods of installation, connections, and operations.
- C. Perform acceptance test of the system with the University of Houston Fire Marshal's Office. Schedule the test at least 48 hours with the U of H Fire Marshal.

END OF SECTION 5.21.20 – SPECIAL HAZARD FIRE EXTINGUISHING SYSTEMS

SECTION 5.28.30 – ELECTRONIC DETECTION AND ALARM

PART 1 GENERAL

1.01 Scope of Standard

- A. This standard is intended to assure that detection/alarm systems at the University of Houston provide the highest level of fire safety possible. This document is not intended to be a guide specification.

1.02 Scope of Work

- A. This standard is to be used in the development of all fire detection/alarm system designs for buildings and structures at the University of Houston.
- B. This standard is to apply to all fire detection/alarm system components and equipment installed at any University of Houston campus during new construction or as part of any improvement project.
- C. The work addressed in this section consists of a fire protection system, which may include, and at least will be coordinated with all of the following building systems or components:
 - 1. Fire Suppression Systems.
 - 2. HVAC and smoke control systems: fire, smoke, and combination fire/smoke dampers.
 - 3. Emergency Power Systems.
 - 4. Elevator installation. See the Texas State Elevator Code ASME/ANSI A17.1 and ASME/ANSI A17.3.
 - 5. Central control and monitoring system.
 - 6. Security Systems.

D. Referenced Publications

The documents or portions thereof listed in this section shall be considered part of the requirements of this document (utilize latest editions).

- 1. NFPA 1, Uniform Fire Code
- 2. NFPA 13, Standard for the Installation of Sprinkler Systems

3. NFPA 14, Standard for the Installation of Standpipe and Hose Systems
4. NFPA 70, National Electrical Code
5. NFPA 72, National Fire Alarm and Signaling Code
6. NFPA 90A, Standard for the Installation of Air-Conditioning and Ventilating Systems
7. NFPA 101, Life Safety Code
8. NFPA 5000, Building Construction and Safety Code
9. IBC-International Building Code
- ~~10. IFC-International Fire Code [deleted]~~
11. UL Standard 268, Smoke Detectors for Fire Protective Signaling Systems
12. UL Standard 268A, Smoke Detectors for Duct Application
13. UL Standard 346, Water-flow Indicators for Fire Protective Signaling Systems
14. UL Standard 521, Heat Detectors for Fire Protective Signaling Systems
15. UL Standard 864, Control Units for Fire Protective Signaling Systems
16. UL Standard 1424, Cables for Power—Limited Fire Protective Signaling Systems
17. UL Standard 1480, Speakers for Fire Protective Signaling Systems
18. UL Standard 1481, Power Supplies for Fire Protective Signaling Systems
19. UL Standard 1711, Amplifiers for Fire Protective Signaling Systems
20. UL Standard 1971, Signaling Devices for the Hearing Impaired
21. ADA-Americans with Disabilities Act
22. TAS-Texas Accessibility Standards
23. American Society of Mechanical Engineers (ASME)/American National Standards Institute (ANSI):
 - a. ANSI A17.1, Elevator Code, latest edition
 - b. ANSI A17.3, Elevator Code for Existing Elevators, latest edition.

c. ANSI A117.1, Accessibility Code, latest edition.

1.03 Objectives

- A. This standard is intended it achieve consistently high levels of fire detection/alarm system performance by:
 - 1. Allowing designers to incorporate required or desired features as early in the design development process as possible.
 - 2. Assuring all systems is designed to meet all applicable codes, ordinances, laws, and sound engineering judgment.
 - 3. Providing a basis for a general understanding among all parties involved in the design of systems.

1.04 Concepts

- A. All systems are to be compliant with applicable paragraphs of National Fire Protection Association (NFPA) Code 101 “Life Safety Code”.
- B. All systems are to be compliant with the requirements of NFPA 72 “National Fire Alarm and Signaling Code”.
- C. All systems are to be compliant with the requirements of NFPA 70 “National Electrical Code”

1.05 System Features

- A. All system product lines must be comprised of components capable of providing the following features when appropriate and specified by the project documents or the University:
 - 1. Floor above/floor below notification.
 - 2. Private alarm notification.
 - 3. Positive alarm sequence.
 - 4. Voice alarm notification.
 - 5. Fireman’s communications.
 - 6. Elevator capture/recall.
 - 7. Elevator power shunt trip.
 - 8. Smoke control/fan shutdown.

9. Door release.
10. Release locks on normally locked egress doors.
11. Release and monitoring of clean agent and/or pre-action sprinkler systems.
12. Monitor non-water based fire suppression systems.
13. Multiple channel voice.

B. Provide audible alarming throughout the building in accordance with NFPA 72.

C. Visual alarming to ADA levels and TAS requirements must be provided throughout the building.

D. Smoke detectors must be provided at all elevator lobbies, elevator equipment rooms and elevator hoist-ways to perform capture/recall functions.

E. All systems must be designed to provide manual means of alarm initiation at every exit from every level. Elevators are not to be considered an exit or route of egress.

F. Smoke detector is required in every corridor and path of egress.

1.06 Description of Work

A. All designs must provide for each building a complete and working digital, addressable, closed circuit, automatic and manual fire detection/alarm system for each floor of the building to perform detection, monitoring, and alarm functions for the building.

1.07 Quality Assurance

A. Installer Qualifications:

1. Authorized and designated representative of fire alarm manufacturer to sell, install, and service proposed manufacturer's equipment. Verify equipment supplier has technical factory training specifically for the system proposed.
2. Licensed by State Fire Marshal to sell, install, and service fire alarm systems.
3. Actively engaged in business of selling, installing, and servicing fire alarm systems for at least five years with minimum of ten such installations completed and operating properly.
4. Equipment furnished shall be of current manufacture.

- B. The equipment furnished shall be listed and approved by a testing laboratory. This listing shall be for all functions required by this specification.
- C. The Contractor shall provide a signed “Fire Alarm Certification and Description” for each system, consisting of completed copies of the appropriate pages from NFPA 72, at the final Acceptance Test.
- D. Provide staff installation superintendents who are licensed by the State Fire Marshal’s Office for such purpose and under whose supervision installation, final connections, and testing will be performed.
- E. All systems must comply with applicable paragraphs of the National Electric Code.

1.08 Submittals

Prior to installation, the following documents shall be provided to the University of Houston Fire Marshal’s Office for reference and/or approval:

- A. Shop drawings: Include manufacturer’s name, model numbers, ratings, power requirements, equipment layout, conduit, device arrangement, and complete point to point wiring diagrams along with other required information including but not limited to:
 - 1. General Drawing Notes
 - 2. Electrical back box requirements
 - 3. Control Equipment Schedules
 - 4. Panel Schematics showing all connections, between modules within panels, to all modules from field wiring with zones identified.
 - 5. Riser Diagrams indicating circuits, type of devices, number of devices, number of conductors, conduit size, junction boxes, and zones.
 - 6. Scaled floor plans with layout of all devices with point numbers for initiating and notification devices, wiring connections, zoning, wire sizes and routing.
 - a. Wattage setting for each speaker labeled adjacent to the speaker
 - b. Candela rating for each strobe labeled adjacent to the strobe
 - 7. Detailed Legend
 - 8. Fire safety and related symbols shown on drawing and diagrams shall comply with NFPA 170.
 - 9. Detailed input/output matrix

- B. Product Data: Provide electrical characteristics, connection requirements and compatibility listing showing that components are compatible with each other including but not limited to:
1. Full equipment list including model numbers and quantities
 2. Complete system operation
 3. Highlighted Data Sheets on Devices and Products
 - a. Fire Alarm Control Panel
 - b. Wiring
 - c. Batteries
 - d. Detectors
 - e. Manual Stations
 - f. Audible Signaling Devices
 - g. Visual Signaling Devices
 - h. Control Devices
 4. Wiring diagrams of all equipment
 5. Installation instructions for all equipment
 6. Equipment testing procedures
 7. Equipment maintenance manuals
 8. Wire data sheets
- C. System Calculations – Complete calculations shall be provided which show the electrical load on the following system components:
1. Each system power supply, including stand alone booster supplies
 2. Standby Battery Calculations plus a 20 percent de-rating factor
 3. Voltage drop calculations for each type of circuit (identify all mathematical formulas, variables, and constants)
 4. dB loss calculations for speaker circuits
 5. Speaker circuit loading and amplifier loading
 6. Strobe circuit loading
 7. Each auxiliary control circuit that draws power from any system power supply
- D. Software and Database Information:

1. Proposed point numbers
 2. Labels of all addressable devices
 3. English action messages
 4. Add programming rules, Equations, with comments listed
- E. The submittal package shall be signed by State of Texas Alarm Planning Superintendent (NICET III) or signed and sealed by a Professional Engineer (P.E.) registered in the State of Texas.

PART 2 PRODUCTS

2.01 Fire Alarm Control Panel (FACP)

- A. Acceptable Manufacturers model Simplex 4100U.
- B. All fire alarm control panels must be intelligent, addressable Central Processing Units (CPU) based and meets the latest edition of UL 864.
- C. All FACPs must be capable of providing circuit integrity monitoring for all Signaling Line Circuits at a level of Class A, Style 6, as defined in NFPA 72.
- D. All FACPs must be capable of providing circuit integrity monitoring of Initiating Device Circuits (IDC's) at level of Class B as defined in NFPA 72.
- E. All FACPs must be capable of providing circuit integrity monitoring of Notification Appliance Circuits (NAC's) at a level of Class B as defined in NFPA 72.
- F. Panels shall have provisions for smoke detector "Alarm Verification" for Signaling Line Circuits must be provided.
- G. Manufactured terminal boxes labeled "FIRE ALARM TERMINAL BOX" Space Age TC series or equal.
- H. With each installed field device affix a label to indicate the devices full address on its signaling line circuit.
- I. Mark each cable or wire to designated terminal with labeling tool.
- J. All FACPs must provide twenty percent (20%) excess power supply, input circuit, and output circuit capacity at final acceptance to allow for future expansion by the owner.
- K. Zone labeling must be textual by alpha-numeric display at the FACP and remote annunciator to allow "first response" by persons not trained in fire alarm technology.

- L. Textual (alpha-numeric) language must be conventional, concise, clear and accurate to facilitate rapid response.
- M. All FACP's must provide a control to silence the Public Alarm to allow for maintenance and testing, and to reduce disruption.
- N. All FACP's must provide a control to override the smoke control/fan shutdown feature to allow for maintenance and testing. Program panel shall allow functions to be disabled by floor or group as required by U of H.
- O. All FACP's must be connected to a Primary and Secondary Power source. The secondary power supply must be sized to provide 5 minutes of operation in alarm conditions after 24 hours of system operation in standby power. Where voice evacuation systems are utilized, 15 minutes of alarm shall be provided.
- P. All FACP's must provide a separate digital address for initiating device to facilitate rapid response and maintenance and testing.
- Q. All FACP's must provide a separate digital address for each individual flow switch.
- R. All programming must be permanent and non-volatile to reduce outage time due to failure.
- S. All FACP's must provide a panel mounted printer to print a log of all status change activity.
- T. All FACP's must be listed and approved as the smoke detector sensitivity test set to reduce maintenance costs.
- U. All FACP's must be capable of providing drift compensation. Drift compensation is considered equal to adjustability at the detector.
- V. All FACP's must be field programmable, using internal or connected components, for all changes, alterations, modifications, additions, deletions, and hardware and software upgrades.
- W. All messages shall be recorded in a male voice.
- X. All FACP's must be capable, using internal or connected components, of generating comprehensive reports for sensitivity, verification counts, address registers.
- Y. Where a clean agent fire suppression system and/or pre-action sprinkler system is specified for the project, the FACP must be UL listed for releasing service the pre-action and/or clean agent system specified in Section 21.20.00. Initiating devices shall be connected to a UL listed releasing panel. All initiating, output and releasing circuits shall reside in one fire alarm control panel.

Z. A fault isolation device shall be provided electrically between each building level. This device shall be capable of automatically isolating wire-to-wire faults on each SLC to the building level involved. The device shall be powered by the SLC loop. The device shall provide visual indication at the device of a short circuit (isolate) condition. The device shall reset to the normal mode upon elimination of the wire-to-wire short. All fault isolation devices shall be physically located within the marshaling box for that floor.

AA. All wiring within the FACP shall be labeled.

2.02 Remote Monitor

A. All systems must be capable of interconnection to the Campus-Wide Proprietary Supervisory Signaling System utilizing one set of Form C contacts (one normally open, one normally closed) for transmission of each of the following signals separately:

1. ALARM
2. WATER-FLOW
3. SUPERVISORY
4. TROUBLE

B. All systems must provide a Wiring Interface Panel (junction box) to accommodate the connection between the new fire alarm system and the existing Proprietary Protective Signaling System. The WIP must be accessible and located within a room that is nearest to the campus utilities tunnel system. Conduit and 18/10 conductor cabling must be provided between this panel and the FACP to perform the functions listed above.

2.03 Distributed Power Supplies

A. Distributed power supplies for powering Notification Appliance Circuits, beam smoke detectors, and control relays may be used.

B. All distributed power supply inputs must be controlled by addressable interface devices located on the same floor as the power supply and controlled by the SLC serving the area to facilitate maintenance.

C. The distributed power supplies must be sized to provide 15 minutes of operation in alarm after 24 hours of system operation in standby power. Where voice evacuation systems are utilized, 15 minutes of alarm must be provided after operation in standby power.

2.04 Manual Pull Stations

- A. All manual pull stations must be of the “double-action” type to reduce unintentional or vandal alarms. Pull stations required to break glass to activate are not acceptable. Provide pull stations that utilize the same key as FACP for resetting.
- B. Each manual pull station must have a unique digital address on the SLC.
- C. Where separate addressable monitor modules are used for monitoring conventional type manual pull stations, the modules are required to be installed within the manual pull station back box.
- D. Every pull station in the public areas must have a tamper proof cover (Stopper II).

2.05 Heat Detectors

- A. All heat detectors shall be fixed temperature, rate-of-rise, or combination fixed temperature and rate-of-rise, spot type.
- B. Each addressable heat detector must have a unique address on the SLC
- C. Non resetting detectors must give visual indication of “ALARM” condition to facilitate rapid response.
- D. Where separate addressable monitor modules are used for monitoring conventional type heat detectors, the modules are required to be installed within the heat detector junction box.

2.06 Smoke Detectors

- A. All spot type smoke detectors shall be photoelectric or combination photoelectric and ionization type.
- B. Each smoke detector, whether spot-type, or projected-beam type, must have a unique digital address on the SLC.
- C. All smoke detectors must be field measurable and adjustable for sensitivity.
- D. All smoke detectors, except projected beam type, must be powered from the SLC.
- E. The FACP must function as the smoke detector sensitivity test set and must be approved and listed for that service.
- F. All smoke detectors must meet or exceed the requirements of Underwriter’s Laboratory Standard 268, as amended, and must be listed and approved for use with the FACP provided.

2.07 Duct-Mounted Smoke Detectors

- A. It is the joint responsibility of the Fire Alarm and the Mechanical Contractors to assure that all supply and return air is sampled as required per NFPA 90A. Label duct work and direction of air flow and identify the proper locations for duct detectors. Provide only addressable system duct detectors, factory installed duct detectors within air handling unit are not acceptable.

2.08 Projected-Beam Smoke Detectors

- A. All projected-beam detectors must operate on the infrared principle.
- B. All projected-beam detectors must have automatic gain control circuits to compensate for deterioration of signal strength due to environmental factors such as dirt and dust accumulation, component aging and temperature fluctuations.
- C. Transmitting and receiving units of projected-beam detectors must be protected from physical damage.
- D. All projected-beam smoke detectors must have circuits to prevent “false” alarms due to sudden and complete obscuration.

2.09 Air Sampling Smoke Detection

- A. Provide air sampling smoke detection system if required by the project.
- B. Locate air sampling ports in accordance with NFPA 72 and manufacturer’s requirements.
- C. Maintain a maximum transport time of 120 seconds, or the transport time specified by the manufacturer, from the farthest sampling point, whichever is less.
- D. Utilize CPVC piping that is listed for use in air sampling systems. Label piping as required per NFPA 72.

2.010 Water-flow Switches

- A. Fire detection/alarm systems must be interconnected to the fire sprinkler systems by water-flow switches must be set for a 60 second delay (retard) prior to the “ALARM”.
- B. Each water-flow switch must be monitored for a unique digital address on the SLC.
- C. It is the responsibility of the Sprinkler Contractor to locate the water-flow switches to assure indication of water-flow within the building and at each level of the building to reduce water damage.

2.011 Supervisory (Tamper) Switches

- A. Connect tamper switches installed on all sprinkler or standpipe system valves to the fire alarm system to indicate closing or opening of the valves.

2.012 Audible Appliances

- A. Fire alarm system audible notification appliances are required to be provided by speakers in all buildings. The fire alarm speakers will also be utilized by the mass notification system for audible notification. The fire alarm signal generated must be the distinctive three-pulse temporal pattern described by NFPA and ANSI codes.
- B. The Evacuation Signal produced by the speakers must be altered with a custom textual message as indicated in Section 3.08 below.
- C. Provide audible systems with voice intelligibility measured in accordance with the guidelines in Annex A of IEC 60849, Sound Systems for Emergency Purposes. When tested in accordance with Annex B, Clause B1, of IEC 60849, the system shall exceed the equivalent of a common intelligible scale (CIS) score of 0.70.

2.013 Visual Appliances

- A. All visual notification appliances must be xenon strobe, compliant with current requirements of ADA and TAS.
- B. All visual notification devices within a room or adjacent space within the field of view must be synchronized as required per NFPA 72.
- C. Strobes used in combination systems where the same strobe is used for both mass notification and fire notification shall be clear or nominal white meeting the listing requirements of UL 1971 and either have no marking or be marked with the word "ALERT" stamped or imprinted on the appliance and be visible to the public.

2.014 Remote Annunciator

- A. When required by the project, an LCD remote annunciator shall be located in an open accessible area acceptable to the AHJ.
- B. Remote annunciator must display the same addressable and common signal information as the main FACP.

2.015 Monitoring Devices

- A. Addressable monitoring devices used to monitor contact-closure initiating devices such as water-flow switches, and tamper switches must derive power from the SLC to which they are connected.

- B. Each monitoring device must have a unique digital address on the SLC.
- C. Monitoring devices used to interface smoke detectors to the SLC shall be limited to existing spot type smoke detectors or duct-mounted smoke detectors.

2.016 Control Devices

- A. Addressable control devices must not control more than one type of appliance/device.

2.017 Documentation storage shall be provided at or adjacent to (within five feet of) the FACP. This storage shall be capable of storing and securing all documents required for system maintenance and response. Storage shall be separated from all active electrical, electronic, or electromechanical parts and components. If adequate, storage may contain unconnected spare/repair parts.

PART 3 INTERCONNECTION AND OPERATION

3.01 Signaling Line Circuits (SLC)

- A. All FACPs must provide circuit integrity monitoring for all Signaling Line Circuits at a level of Class A, Style 6.

- B. All the following devices/appliances must be individually addressed on the SLC:

1. Smoke detectors
2. Heat detectors.
3. Manual stations.
4. Monitor devices.
5. Control devices.
6. IDCs.
7. Audio NACs.
8. Visual NACs

- C. No splicing of the wiring is acceptable. No wire nuts may be used only terminal strips contained within a terminal box.

3.02 Initiating Device Circuits (IDC)

- A. Initiating Device Circuits (IDCs) must be monitored at a level of Class B.

- B. No splicing of the wiring is acceptable. No wire nuts may be used only terminal strips contained within a terminal box.

3.03 Notification Appliance Circuits (NAC)

- A. All Notification Appliance Circuits (NAC) must be monitored at a level of Class B.
- B. Direct current notification appliance power provided from a distributed power supply must be controlled by a digital addressable control device on the SLC.
- C. Audible notification appliances and visual notification appliances must always be connected to separate NACs to facilitate maintenance.
- D. No splicing of the wiring is acceptable. No wire nuts may be used only terminal strips contained within a terminal box.

3.04 Auxiliary Functions

- A. Locate control devices utilized for operating auxiliary functions mounted within 3 feet of the system being controlled as required per NFPA 72.

3.05 Floor Above/Floor Below Notification

- A. Selective evacuation shall be permitted if approved by the U. of H. Fire Marshal.
- B. In high rise structures, each level must constitute a minimum of one audio Notification Appliance Circuit and one visual Notification Appliance Circuit. NACs must be capable of initiating a general alarm or allow selectable notification.
- C. The FACP must also provide a control to the panel to allow sounding the Public Alarm throughout the structure (All-call) and activate both audio and visual notification for building evacuation at the FACP.

3.06 Positive Alarm Sequence

- A. Positive alarm sequencing shall be permitted.

3.07 Voice Alarm Notification

- A. When required by code, the audible portion of the Public Alarm for all systems must be a Voice Alarm. Provide speakers for annunciation of voice messages. Signal generated must be the Distinctive Evacuation Signal (three-pulse temporal pattern) alternated with a digitized custom textual message.

- B. Audible message required for voice evacuation shall be as follows:

The standard campus evacuation message shall play.

- C. The digitized audible message shall sound twice, and then the three-pulse temporal pattern shall resume.
- D. The FACP shall provide a microphone and associated controls to allow voice paging to selected areas.

3.08 Fire Department Communication System

- A. Where required by code, provide a complete and separate two-way fire department communication system.
- B. Electrically supervised two-way fireman's phone jacks must be provided at the entrance to all elevators, enclosed stairwells, elevator lobbies, and emergency standby power rooms. Phone jacks are also required in fire pump rooms and fire command centers, where provided.
- C. Wiring for the Fireman's Communication System may be installed in common raceway or conduit utilized by the fire alarm system.

3.09 Elevator Recall

- A. Provide elevator recall in accordance with ASME A17.1, ASME A17.3, and NFPA 72.

3.010 Fan Shutdown

- A. Initiation by duct-mounted smoke detectors must cause shutdown of associated air handling units and alarm signal at the fire alarm control panel. Motor control circuits must not be routed through the housing.
- B. The SLC must connect to a control device within three feet of the motor starter or other approved location to interrupt the motor control circuits.
- C. The control device must be assigned a unique digital address on the SLC.
- D. A "BYPASS" control must be provided at the FACP.
- E. Where a smoke control system is provided, connect FACP to smoke control panel for initiation of smoke control system and associated dampers in accordance with NFPA 92A and NFPA 92B. The smoke control panel, provided by others, is required to comply with UL 864 and listed as smoke control equipment.

3.011 Automatic Door Control

- A. Automatic Release-to-Close

1. Smoke control doors normally held open electrically must be allowed to close upon any “ALARM” condition.

B. Automatic Unlock

1. Access control door normally electrically locked for security must unlock on any “ALARM” condition.

3.012 Wiring

- A. Basic wiring materials and installation must comply with NFPA 70.

- B. Conductor sizes must be sized in accordance with NFPA 72 and NFPA 70 to provide the minimum required voltage drop.

- C. Install wiring in conduit or raceway where required per NFPA 70.

- D. All system wiring shall be color coded in accordance with the following:

1. Power circuits-Black
2. Strobe circuits-Yellow or White
3. One way voice speakers-Blue
4. Signaling line circuits, initiating device circuits, network communications cable-Red
5. Ground conductor-Green
6. Elevator interface wiring must meet NEC 620.
 - a. Main Floor Recall-Red
 - b. Alternate Floor Recall-Blue
 - c. Fire Hat Signal-Yellow
 - d. Supply power-Black

- E. Circuits extending beyond buildings

1. Where circuits are required to extend outside of the building, wiring must be provided with primary protectors in accordance with NFPA 70 Article 760 and Article 800.

PART 4 SPECIAL CONDITIONS

4.01 General

- A. It is the responsibility of the Contractor to assure that there is no disruption of the University’s normal functions during construction such as studying, testing, class, research, or administration.

4.02 Connecting to Existing Systems

- A. Operations of and connections to existing fire alarm systems must be supervised and/or coordinated by the University of Houston Fire Alarm Shop (FAS) Shop staff and the Fire Marshal's Office. A permit is required.
- B. Existing systems must remain operational during modifications or additions to the existing system throughout the duration of the project.
- C. Where part or all of the existing fire alarm system is required to be demolished, remove the existing fire alarm components only after the new system installation is complete and accepted by the Fire Alarm Systems Shop (FAS) and the U. of H. Fire Marshal.
- D. Existing equipment that is required to be salvaged by the University shall be stored in a secure area designated by the University.

4.03 Pre-action and Clean Agent Releasing Systems

- A. Where the project requires releasing of a pre-action and/or clean agent system, the room or area in which the suppression system is located shall utilize two separate smoke detectors or activation of a manual release station to activate the suppression system.
- B. Reduce smoke detector spacing for rooms or areas utilizing high airflow as required per NFPA 72.

4.04 Smoke Control System

- A. Where a smoke control system is required for the project, connect FACP to smoke control panel for initiation of smoke control system and associated dampers upon activation of sprinkler system water flow switch and/or total coverage smoke detection system located within the area requiring smoke control. The smoke control panel, provided by others, is required to comply with UL 864 and listed as smoke control equipment. Where a smoke control system is required, the FACP shall provide the relay interface to a separate smoke control panel compatible with the Building BAS system.
- B. In the event a fire alarm control panel is to be utilized for smoke control functions, it must be listed in accordance with UL 864 as smoke control equipment.

4.05 Mass Notification System

- A. Include the additional equipment required to connect to the future campus wide mass notification system. Fire alarm speakers and speaker/strobes will be utilized for the audible portion of the mass notification system. Coordinate with U of H for

additional requirements involving equipment and connection to mass notification system.

PART 5 TESTING

5.01 General

- A. Upon completion of the system, the Contractor must perform a complete and comprehensive test of the entire system in accordance with the provisions of NFPA 72. Contractor shall document their testing electronically using logging software commonly available.
- B. It is responsibility of the Contractor to demonstrate to the University that the system is installed and functions in accordance with the project documents and applicable codes.

5.02 Specific Tests

- A. An acceptance test will be conducted at the completion of each project. The test will be the responsibility of the contractor and must be performed in strict compliance with the provisions of NFPA 72.
- B. In addition to the provisions of NFPA 72 and/or the above paragraph, it is the responsibility of the Contractor to provide all of the following:
 - 1. Smoke detector sensitivity report.
 - 2. Pressure differential reading for duct detector sample air flow.
 - 3. Closed loop resistance and EOL resistance readings for all field wiring.
 - 4. Programming volatility test.
- C. Third Party Testing

- 1. Third party testing shall be conducted by an independent third party reporting to and approved by the U. of H. Fire Marshal's Office. Third Party testing shall include repeating all of the tests described in "Contractor's Test" above. A detailed listing of any deficiencies found during these tests shall be forwarded to the Contractor and shall serve as a punch—list for the system.
- 2. The U. of H. Fire Marshal's Office may, at its sole option, witness and/or participate in any and all tests.

3. If, at any point during their tests, the Third Party finds significant deficiencies they are to report those to the U. of H. Fire Marshal's Office who will then determine the appropriate course of action. If the Owner determines that the number and/or severity of the deficiencies so justify, they may stop the Third Party testing and instruct the Contractor to correct the deficiencies and recertify the system. Such retesting shall include Supervision testing of 100% of the Initiating Device Circuits, Notification Appliance Circuits, and Signaling Line Circuits.
4. If retesting by the Third Party is required due to significant deficiencies in the work of the Contractor, the Contractor shall reimburse the Owner for the cost of the Third Party tests conducted to that point.

D. Fix Deficiencies:

1. A copy of the formatted check list shall be transmitted to the contractor to serve as a punch list for the correction of the noted deficiencies. The Contractor shall notify the verifying party in writing that the deficiencies have been corrected along with a copy of the punch list with the corrected deficiencies initiated by the Contractor to indicate the corrections.
2. The Contractor shall provide updated certification forms as set forth in Section II Certification of this document.

E. Third Party Retest:

1. Each deficient item shall be retested. Retesting of the system shall be conducted in accordance with NFPA 72, Table 14.4.2.2, Test Methods. If any software changes are made to the system updated site-specific software print out with all changes highlighted will be submitted to the verifying party prior to the start of retesting.

F. Third Party Certification:

1. The Third Party shall then retest each portion of the system affected by the corrections. If no additional deficiencies are found, the Third Party shall issue a "Third Party Certification" stating that they have tested the system and certify that it complies with the appropriate sections of NFPA 72. Such certification shall not contain any disclaimers or similar comments.

G. Campus Test and Acceptance:

1. Upon receipt of all documents from the final "Contractor's Certification" and the "Third Party Certification," the (FAS) and /or U. of H. Fire Marshal will conduct any tests it determines to be necessary, consistent with the specified survivability style and performance requirements for the system. If

no additional deficiencies are found, they will accept the system. If additional deficiencies are found, the Contractor will be required to correct the deficiencies, re-test and re-certify the system. Such re-testing shall include Supervision testing of 100% of the Initiating Device Circuits, Notification Appliance Circuits and Signaling Line Circuits. The Third Party shall then re-test each portion of the system affected by the corrections. If no additional deficiencies are found the Third Party shall re-issue a “Third Party Certification” as set forth in Section VI Third Party Certification of this document.

H. Fire Alarm Testing Overview:

1. Note: The Campus Fire Marshal may, at its sole option, require assistance and/or participation of the Contractor in this testing.

Fire Alarm System Testing Overview				
	Contractor	General Contractor	U. of H. Fire Marshal’s Office	3 RD Party
I. Contractor’s Test	X	X		
II. Contractor’s Certification	X	X		
III. 3 rd Party Test	X	X	X	X
IV. Fix Deficiencies	X	X		
V. 3 rd Party Retest	X	X	X	X
VI. 3 rd Party Certification				X
VII. Campus Test and Acceptance	X*	X*	X	

2. References:

- a. Texas Administrative Code, Title 28. Insurance, Part 1. Texas Department of Insurance, Chapter 34. State Fire Marshal, Subchapter F. Fire Alarm Rules.
- b. National Fire Alarm Code (NFPA 72), 2002 edition

PART 6 DOCUMENTATION

6.01 General

- A. A documentation package must be provided by the Contractor before final testing with FAS and U. of H. Fire Marshal that shall include all information needed to allow the University to perform additions, modifications, maintenance, and repair of the system.

B. This must include:

1. Equipment schematic diagram for all components and modules.

2. Equipment technical data.
3. Field Device address register
4. Equipment repair parts lists.
5. Programming disk with all system software required for a restart after traumatic failure. Software must be of appropriate and compatible update version for the firmware installed including hardware key, if required.

C. “As-Built” wiring, conduit diagrams to include:

1. Floor plan layout drawings showing all significant conduit routes and sizes, wire amounts, sizes and color code and marshaling box locations.
2. Riser diagram showing all significant conduit routes and sizes, wire amounts, sizes and color code and marshaling box locations.

D. Floor plan device layout drawing to include:

1. All initiating device locations and digital addresses.
2. All notification appliance locations and NAC digital addresses or device number.
3. All control device locations and digital addresses.
4. All monitor device locations for supervisory switch groups.
5. All distributed power supply locations and digital addresses.
6. Schematic representation of all SLCs, NACs, control circuits, audio circuits, and power circuits.

E. Riser Diagram to include:

1. All initiating devices with their electrical location and digital address on the SLC.
2. All notification appliances with their electrical location and device number or digital address on the SLC.
3. All control devices with their electrical location and digital address on the SLC.
4. All supervisory switch locations and their interconnection to the monitor device (IDCs).
5. All monitor devices with their electrical location and digital address on the SLC.
6. All distributed power supplies with their associated wiring and digital addresses on the SLC.
7. Schematic representation of all SLCs, NACs, audio circuits and power circuits.

F. Interconnection diagram(s) for all internal components of the Fire Alarm Control Panel, including switch settings, jumpers, module addresses, and Terminations on drawings.

G. State of Texas (FML009) or NFPA certification form.

- H. Programming guide for the functional programming to provide for field changes to the zone schedule or other operational features.
- I. Backup copy of the operating system and/or all resident programming, software or firmware, which would be required to restore the system for full operation after a complete failure or equipment replacement.
- J. A system hardware component capable of storing and transporting the above listed programming and operating systems and reports.
- K. Provide factory logging software for periodic testing.

6.02 Warranty

6.03 Warranty Maintenance

- A. The Contractor shall warranty all materials, installation and workmanship for one (1) years from date of acceptance by the University of Houston, unless otherwise specified. A copy of the manufacturer's warranty shall be provided with closeout documentation and included with the operation and installation manuals.
- B. Materials, installation or workmanship found to be defective during that period shall be replaced without cost to the University of Houston. This Contractor shall initiate repair of any warranty defects within 8 hours of notification of such defects and shall be repaired within 24 hours.
- C. The warranty or any part of the warranty shall not be made void by any required operation or inspection of the system after acceptance during the warranty period. The University of Houston will use University of Houston personnel to provide required tests and inspections.
- D. If the Owner experiences more than two Nuisance alarms or unexplained false alarms or troubles in any 24-hour period while the system is under warranty, the Contractor shall provide the necessary labor, materials, and technical expertise to promptly correct the problem(s) at no cost to the University of Houston.
- E. The fire alarm contractor shall maintain a service organization with adequate spare parts stock within 75 miles of the installation.
- F. Spare Parts – The Contractor shall supply the following spare parts:
 - 1. Automatic detection devices – Two (2) percent of the installed quantity of each type.
 - 2. Manual fire alarm stations – Two (2) percent of the installed quantity of each type.

3. Modules – Two (2) percent of the installed quantity of each type.
4. Audible and visible devices – One (1) percent of the installed quantity of each type and color, but no less than two (2) devices.
5. Keys – A minimum of three (3) sets of keys shall be provided and appropriately identified.

6.04 Training

- A. Provide services of manufacturer's representative to instruct Owner's personnel in operation and maintenance of system for a minimum of two 4 hour sessions.
- B. Factory training at the expense of the Fire Alarm Contractor for two U of H FAS personnel is required for the installed system.

END OF SECTION 5.28.30 – ELECTRONIC DETECTION AND ALARM