

SECTION 6.0

LANDSCAPE DESIGN GUIDELINES

NOTE:

The “Landscape Design Guidelines” outline the external landscape and open space features and elements that shall be considered in any proposed landscape project on the University of Houston campus. As a section of the University of Houston Design Guidelines and Standards, all codes, ordinances, and conditions that apply to the University of Houston System Procurement and Delivery Procedures also apply to the “Landscape Design Guidelines.

6.1 OVERVIEW

6.1.1 Preface

The original UH Campus Plan developed by Hare & Hare in 1937 established a formal framework of buildings, spaces and connections organized along axial lines. In contrast, actual campus landscaping practice duplicated the informality of the natural surroundings, particularly the woods as they extended from Brays Bayou. As the campus itself grew, the park-like nature of the campus increased, as roads were closed, axes were blocked and auto circulation was routed around the perimeter of campus with limited penetration.

Departing from the axial framework, developments after 1966 adopted a more informal and spontaneous pattern of building locations while still adhering to the orthogonal orientation of the original plan. More recent developments have focused on strengthening the axial pathways and transforming the open space between buildings from left over space into active spaces which engage with the neighboring buildings.

The intent of these landscape guidelines is to achieve a high level of quality in the design of landscape treatments while maintaining an order and structure to the campus, cultivating visual diversity; and providing a conceptual framework for a distinct campus identity.

Landscape regulations:

Pursuant to Texas Government Code Section 2166.404, xeriscape landscaping design is required on new construction projects. Houston’s high heat and humidity, claylike soils, and high water table conditions vary from the dry environmental conditions suitable for typical Texas xeriscape landscaping. The University of Houston practices water-saving landscaping by appropriate plant selection, limiting turf areas in perimeter areas, efficient irrigation, and generous mulching.

Landscape objectives include:

- A pedestrian campus which prioritizes its open spaces.

- Integrity of core campus' open spaces while accommodating facilities' growth.
- New campus gathering places of varying character that are harmonious with the scale of existing surroundings.
- Physically identifiable and pleasing presence of the campus upon arrival.
- Extension of the indigenous landscape and recreational uses of the adjacent bayou park system into the campus.
- Inclusion of native plantings which acknowledge the seasons, and shade and water elements.
- Appropriately lit exteriors which support nighttime activities and promote security.
- Support for key CPTED (**Crime Prevention Through Environmental Design**) security concepts: natural surveillance, natural access control and natural territorial reinforcement. **The City of Houston provides a good resource for this design strategy at http://www.houstontx.gov/police/pdfs/cpted_infopage.pdf.**

6.2 LANDSCAPING OF CAMPUS EDGES

6.2.1 General

Establish standards for the landscape treatment of campus edges and for the creation of a distinctive, positive image that fixes the University within a landscape context that represents the University and the environment of the region. Landscape treatments shall consider urban design elements such as sense of place, sense of entry, view corridors, visual buffering, adjacent land uses, natural features and connection to the host community. Consideration shall also include the concept of extending and reinforcing the bayou woods particularly along Martin Luther King Blvd.

During schematic design of major building projects on campus, representatives of Campus Planning and Landscape Planning & Grounds shall be involved with the design consultant in design decisions and the overall vision of the landscape scheme.

6.2.2 Recommendations

The scale and character of the Campus edges that front highways is greatly influenced by the speed and distance of motorists that pass by the campus or enter the campus. The scale of plantings along the highway shall consist of large massing of trees that reflect both the formal and informal characters of campus. Consider view corridors, alignment, points of reference, and screening where appropriate.

The scale and character of campus edges adjacent to surrounding districts and neighborhoods shall communicate a strong sense of a campus **threshold** without creating a physical and visual barrier. Consider crossable boundaries that allow unobstructed pedestrian and vehicular access.

The natural woods that extend through the Campus from Brays Bayou shall be expanded to accentuate the bayou connection and to act as a landscape buffer between the surrounding highways and the Campus.

6.3 LANDSCAPING OF GATEWAYS

6.3.1 Existing Condition

UH has two major entrances possessing landscape features of the type and scale to create a sense of arrival on the campus. The Cullen Blvd. Entrance from I-45 achieves this with a pair of split granite obelisks at the northern end, and with flanking rows of oak trees and ornamental light posts and banners. University Drive off the Spur 5 access road has similar edge conditions and terminates in the campus' most iconic building, Ezekiel Cullen. Elsewhere on campus, the construction of the Health & Biomedical Science Building adjacent to the Armistead Optometry building, together with the METRO Southeast Corridor light rail station on Wheeler Street at MLK Blvd., has created another gateway condition at the southeast corner of campus.

6.3.2 General

Substantially enhance and beautify the landscape treatment at the appropriate locations to create significant gateways commensurate with a major university and create a memorable front door image. Gateways should be appropriately scaled.

6.3.3 Recommendations

6.3.3.1 Major Gateways

Major vehicular gateways shall be appropriately reinforced with landscape and architectural features to signify entrance and arrival. Gateway walls, monumentation, graphics, and colors shall be in scale with a major institution. Landscape elements shall be bold and simple in arrangements, massing, and alignment.

Consideration shall be given to view corridors, alignment, points of reference, and screening where appropriate.

Consider utilizing tall vertical gateway elements (Figure 6.3.1) similar to the Cullen gateway without duplicating the style.

6.3.3.2 Portals



FIGURE 6.3.1

Portals, entry points to the campus less significant than gateways, shall be appropriately reinforced with landscape and architectural features to signify entrance and arrival. Portal walls, monumentation, graphics, and colors shall be in scale with a major institution but also in scale with the surrounding community. Landscape elements shall be simple in arrangement, massing, and alignment. (See Figure 6.3.2)

Consideration shall be given to view corridors, alignment, points of reference, and screening where appropriate. Portal size shall strike a balance between vehicular and pedestrian scale.

Materials and color for Portals shall be uniform and consistent throughout campus.



**FIGURE 6.3.1
PORTAL**

6.4 LANDSCAPING OF CAMPUS STREETS

6.4.1 General

Establish structure and clarity for vehicular circulation routes by utilizing consistent landscape treatment on the internal circulation routes and on the approaches to the UH campus, existing and proposed. Landscape treatments shall reinforce vehicular corridors, and shall project a campus image in the streets surrounding the campus.

6.4.2 Recommendations

Internal campus streets shall have a single row of regularly spaced canopy trees along both sides of the street continuing for the entire length of the street. Use of a singular species for each street with a spacing of 30'-40' on center is recommended. Trees may be different species for different streets, but mixing species within any particular street is discouraged. The trees shall be regularly spaced in a consistent alignment to distinguish them from adjacent landscape treatment and to reinforce the vehicular corridors. The ground plane shall be predominantly sod, with low maintenance groundcovers or native shrub areas at special points or entrances, if appropriate. Walkways shall border both sides of the street.

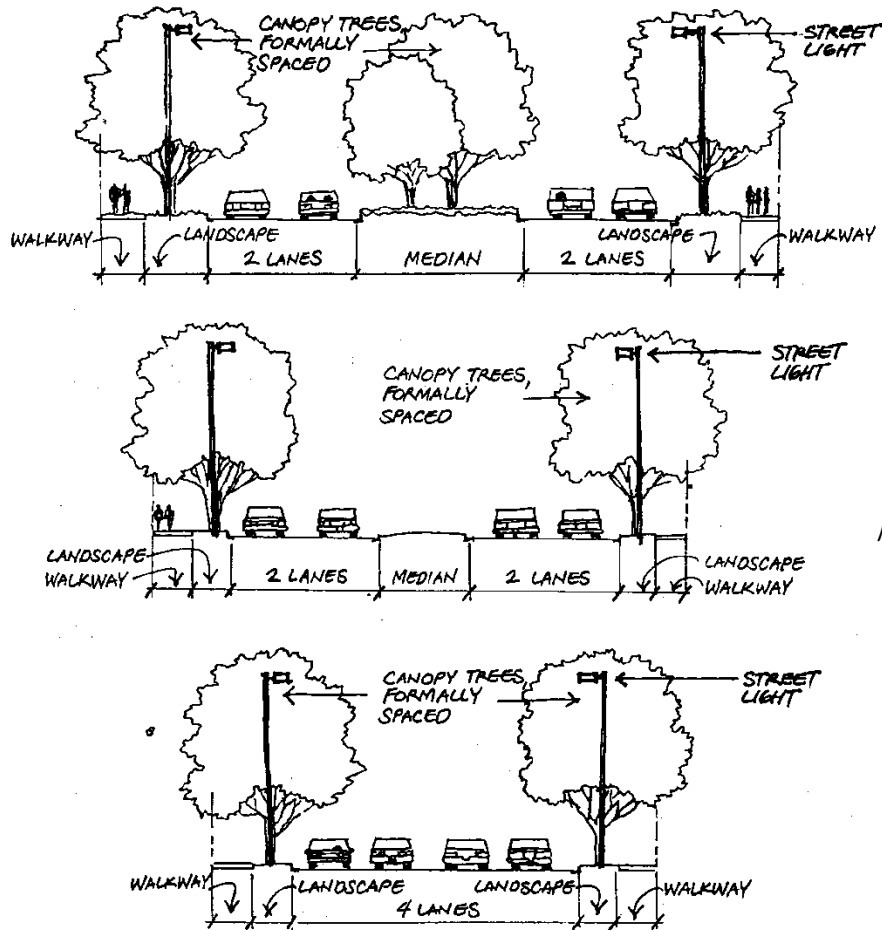

FIGURE 6.4.1
LANDSCAPING OF CAMPUS STREETS

Work within an overall conceptual framework for development of landscape elements on the campus. Establish a street tree planting based on a hierarchy of street types. Reinforce and extend current street tree planting program. Coordinate street landscape treatments with walks, lights and signage.

6.5 LANDSCAPING OF PARKING AREAS

Refer to **Section 9.13** of the Campus Design Guidelines and Standards for landscaping requirements of parking areas.

6.6 LANDSCAPING OF WALKS

6.6.1 Existing Condition

Sidewalks shall be standard broom finished concrete. There is, however, a significant amount of existing exposed aggregate concrete walks and care shall be given in transitioning between existing aggregate-finished walks and new broom-finished sidewalks.

6.6.2 General

Observe a hierarchy of systems, typology, scale, consistency of materials, and structure of pedestrian walkways to help define and articulate open spaces and enhance campus wayfinding. Create a more intriguing walkway environment. Promote and encourage a lively urban pedestrian environment in the streets surrounding the campus.

Differentiate between formal walks such as pedestrian malls and informal walks that follow a natural pattern of circulation.

6.6.3 Recommendations

Existing campus walks are characterized by curving, diagonal, intersecting and parallel walkways that reflect strong natural desire lines. Walkways that interconnect courtyards and academic clusters shall also follow the concept of diagonal walkways respecting desire lines and parallel walkways adjacent to vehicular circulation routes.

A primary walk system shall be developed that establishes a hierarchy of walks, with a select few given dominance over the existing walks. Priority should be given to major pedestrian routes by creating wide sweeping continuous pedestrian walks. **(See Figure 6.6.1)**

All other pedestrian circulation systems should be subservient but complementary to the primary pedestrian walk system.

For all pedestrian circulation typologies, there shall be established a hierarchy of materials and dimensions. As a rule of thumb, all walkways shall be designed to carry light vehicle traffic and shall have a minimum pavement thickness of 4". Minor walkways shall be a minimum of 6' wide, mixed use pedestrian and bike walkways shall be a minimum of 8' wide, and major walkways shall be a minimum of 12' wide.

Walkways and special pavements shall not become subservient to individual buildings and their complementary materials. The width of the pedestrian circulation routes shall vary and be established by hierarchy, usage and urban design considerations.

A common palette of materials shall unify the entire campus. As a base material, concrete shall be the dominant walkway material. The finish, scoring and connection details shall be consistent and uniform. Special materials, patterns, banding, etc., may be used to articulate Pedestrian Malls, Plazas, or special features. Paved pedestrian entrance areas shall be simple and relate to overall pavement of open space circulation. Heavily articulated and patterned pavement is discouraged unless consistent with Pedestrian Malls or major campus circulation treatment.

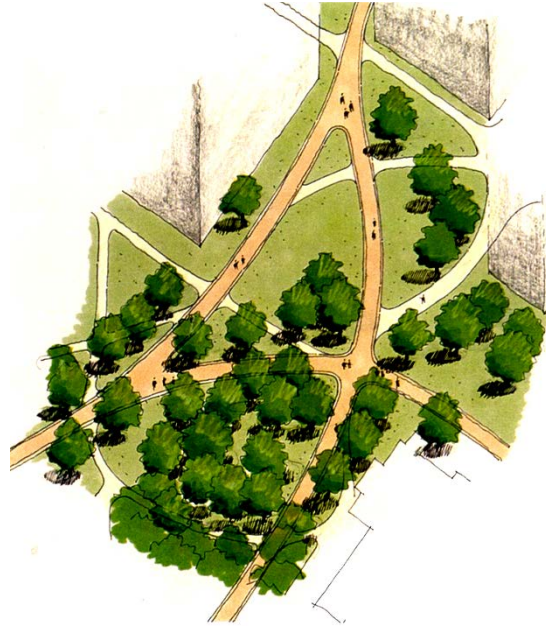

**FIGURE 6.6.1
WALKS**

6.7 LANDSCAPING OF OPEN SPACES

6.7.1 General Guidelines

There exist on campus a large number of spaces that vary considerably in size, condition, formality, and significance. Some have been formally identified as named spaces, others are known by association with surrounding buildings or streets, and others are proposed for future development within recent master planning exercises.

This section establishes landscape treatments for various open space typologies, based upon the following categories of campus structure:

- Quadrangles, Courtyards, Plazas
- Pedestrian Malls
- Pedestrian Nodes
- Campus Greens
- Outdoor Gathering Areas
- Athletic Fields
- Planting Areas Around Buildings

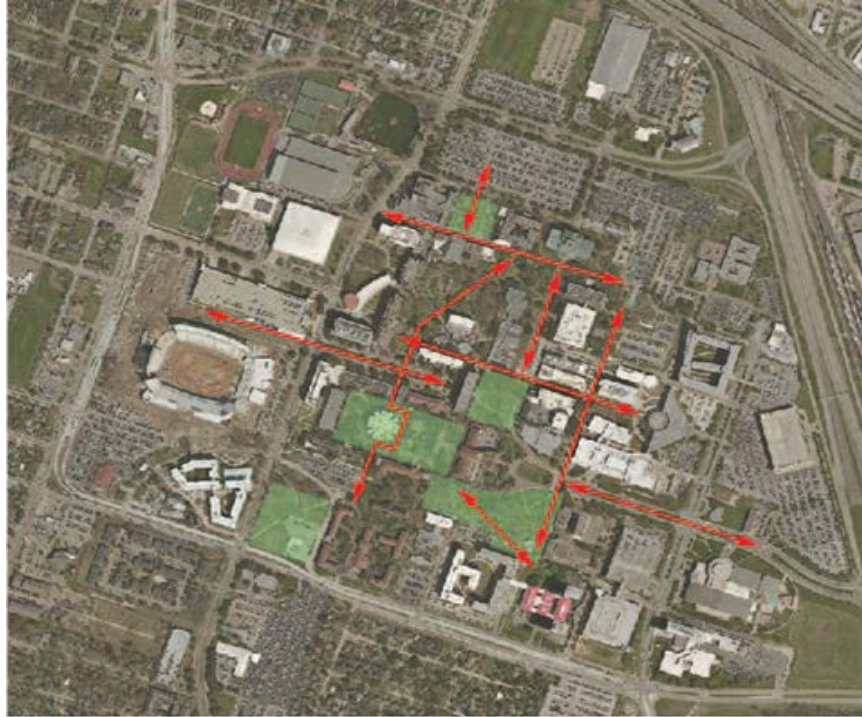

FIGURE 6.7.1
MAJOR LANDSCAPE AREAS AND PEDESTRIAN PATHS

6.7.2 Recommendations

6.7.2.1 Courtyards

As noted in prior land use development plans, an open space system allows the existing linear walks and paths to extend the campus. Over time, new courtyards are anticipated which will be similar in size and nature to the many that exist today and which will serve as front door addresses for new buildings within each district.

Landscape treatment shall utilize walkways that parallel and define the boundaries of the courtyard. Simple, open, grass areas and tree massing shall reinforce the open space. Plant groupings can be formally or informally spaced, but the overall treatment shall re-enforce qualities of space and place within the courtyard. Individual landscape treatment of buildings, as they abut the courtyard, shall reinforce the totality of the courtyard and its special sense of place. Features such as fountains, monuments, sculpture, and special site furniture can occur at selected intersections of walkways and expanded pavement areas. (See **Figure 6.7.2**)

In addition to spatial reinforcement, the placement of landscape treatment shall reinforce significant visual straight lines, points of connections, axial relationships and building entrances. Pedestrian lighting, street furniture and signage shall also complement and reinforce the sense of a unified open space. Courtyard landscape treatments shall set them apart from Pedestrian Malls.

Courtyards shall also include seating areas for informal study and shall provide areas of sun and shade.

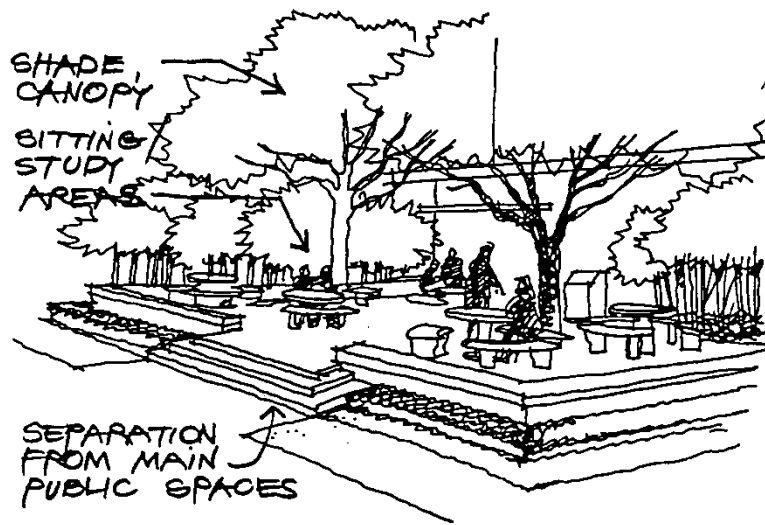

**FIGURE 6.7.2
COURTYARD**

6.7.2.2 Pedestrian Malls

A Pedestrian Mall is a significant linear pedestrian promenade. (See **Figure 6.7.3**) It accommodates a significant volume of pedestrian traffic and functions as a major collector and as a major linear open space. At significant intersections and connecting points, the Pedestrian Mall shall be highlighted with an expanded plaza, which will serve as a focal point and meeting place. Significant features include regularly spaced, large canopy trees of a single species forming a shaded esplanade flanking an expansive lawn. Landmarks shall be considered as termini to the Mall. (See **Figure 6.7.4**)

The mall shall be detailed with special pavement and/or accent banding to provide interest and pedestrian scale. The materials selected shall be elegant, simple and timeless. The pavement material shall also be capable of being repaired and replaced with ease and consistency. The placement of benches, pedestrian lights and landscape shall reinforce the linear aspects of the mall. The mall design should facilitate strong directional movement. (See **Figure 6.7.2.2**)



**FIGURE 6.7.3
PEDESTRIAN MALL (FUTURE ARTS WALK)**

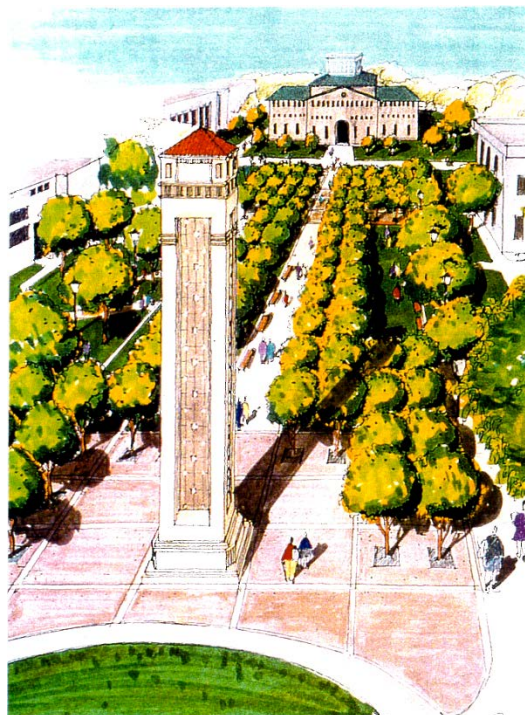

**FIGURE 6.7.4
CAMPUS LANDMARK (CONCEPT IMAGE)**

6.7.2.3 Pedestrian Node

Where there is a major confluence of pedestrian traffic, a pedestrian node shall celebrate the intersection as a special meeting place and point of reference. The pedestrian node shall function as an oasis characterized by a dominance of paving and tree canopy. Consideration shall be given to landscape treatments which are more urban in character, such as tree pockets, seating and special features, e.g. specimen plant material, fountain, kiosk, etc. Coordinate with Campus walks, lights, and signage.

6.7.2.4 Campus Greens

Campus Greens shall have a completely different character than the structured organization of quadrangles and malls. Literally parks, the Greens are informal open space corridors that meander through Campus in park like settings. Large drifts of tree massing shall define and reinforce Greens edges, screen out adjacent uses and generally create a very naturalistic open space/park area that is in sharp contrast to the rest of the campus. Flowering trees and a variety of plantings shall emphasize an arboretum-like display. Large, expansive lawns shall offset and complement large areas of shade and canopy. Walks shall be naturalistic and meander through the Greens. Greens can be remnants of the existing bayou woods or they can be man-made areas that emulate the natural character of the woods. Coordinate with Campus walks, lights, and signage.

6.7.2.5 Outdoor Gathering Areas

The Campus Master Plan for 2015-2020 (DesignLab) identified the following landscape goals:

- Achieve a destination campus with signature pedestrian corridors linking housing, classrooms, research assets, and student life amenities.

- Construct outdoor gathering spaces between research clusters and academic units to further collaborative engagement.

Collaborative outdoor spaces are envisioned for each campus district; the first example of which is the redeveloped Grove in the Arts district. (See **Figure 6.7.5**)



FIGURE 6.7.5
CAMPUS GREENS (FINE ARTS GROVE)

6.7.2.6 Athletic Fields

If feasible, athletic fields shall be located and organized to reinforce vistas into campus and views of landmark buildings. The fields shall consist of large grassed areas defined by ample massing of trees. The planting of trees between and around fields shall create large, outdoor rooms that scale down expansive open space. Landscaping shall also buffer and transition the fields from parking lots and building zones. Fields shall be integral with the Campus open space framework of shaded pedestrian walks. Coordinate with Campus walks, lights, and signage.

6.7.2.7 Landscaping Adjacent to Buildings

Landscape treatment adjacent to buildings shall be simple with a limited plant palette. Massing and size of planted areas shall be in scale with buildings and complement or reinforce the landscape of the open space areas and the campus landscape character. Mow strips are mandatory.

Landscape treatment shall consider reinforcement of main entrances, side and back yards. Placement of trees shall reinforce the architectural elevations. Priority shall be given to issues of safety and, therefore, heights of shrubs and small trees shall be limited to ensure adequate sight availability. Consideration shall be given for year-round color.

Service areas shall be adequately screened from general view using hedges, buffer planting and/or architectural walls. Dumpsters exposed to public view shall be fully screened. Coordinate with campus walks, pedestrian light poles, and signage. **(See Figure 6.7.6)**



**FIGURE 6.7.5
LANDSCAPING ADJACENT TO BUILDINGS**



**FIGURE 6.7.6
SERVICE AREA SCREENING**

6.8 PLANTING

6.8.1. General Guideline

In conjunction with buildings and facilities, planted areas shall serve to strengthen campus identity, reinforce open spaces, and create a comfortable environment. Campus planting, especially oak trees, street trees, and park-like settings, shall also establish a structure of continuity for the campus, helping to tie old and new sections, and the many architectural styles, together into a cohesive statement.

Over the last several years, earlier landscape guideline recommendations related to formal tree planting, native plants, and specialty gardens, and have been realized. A palette of plant materials for use on campus (please contact Architectural Landscape Manager for this information) has been developed which supports an attractive, harmonious and easily maintained landscape. An energy-efficient, environmentally responsible irrigation system has also been widely implemented, and a landscape master plan continues to develop.

Landscaping treatments vary across the campus. The core campus (the area bordered by Elgin, Calhoun, Wheeler, and Cullen) is treated consistently with turf acting as the primary surface to allow for student recreation. Where turf will not grow ground covers are desirable, and decomposed granite may be used in challenging growing conditions and in special accent areas. Live oaks are the dominant tree in this area and asian jasmine planting beds are at installed at their base.

As the landscape nears the core campus edges, landscape treatments transition to more drought tolerant, and in some cases more arid, schemes.

Visual coherence and consistency shall be achieved with the use of a limited plant palette. The overall campus landscape shall be not only unified, but shall also display a regional and indigenous character.

Functional and aesthetic design shall consider scale, hierarchy, context, adjacencies, spatial definition, screening, buffering, shade, view corridors, and seasonal color. Landscape and plant material shall complement the building and articulate main entry points and provide transitional zones between buildings area and larger, common open spaces and circulation areas. Plants shall also buffer or screen unsightly areas and reinforce larger landscape systems such as pedestrian malls and streetscapes.

Long-term maintenance requirements are a consideration for plant selection. Longevity and permanence are also a significant factor. Plants that grow quickly, thereby requiring more maintenance, pruning, etc., are discouraged. Additionally, plantings shall be designed and located in a manner that is conducive to easier maintenance. For instance, a landscape zone that has a multitude of species will require greater maintenance than a simpler mass planting of a single material with an occasional accent plant.

Personal security and safety is a significant factor in selecting plant material and specifying their location. Coordinate with DPS regarding planting and campus security and safety needs. Generally, there should be a clear visual zone between approximate knee height and sight line (or underside of the tree canopy) for all plantings to allow unobstructed views.

All landscaped areas shall be permanently and adequately irrigated as described in section 6.9 below. Existing and/or relocated trees and plants shall be protected and moved according to UH grounds maintenance requirements. (See Master Specification Section 01 50 00: Temporary Facilities and Controls.)

The final selection of plants chosen for use should be based on the following characteristics: low maintenance, low water use, long life, native or indigenous to the region; and non-native plants that thrive

in this locale. The University requires that all new trees have a minimum caliper of 4” at installation. Final plant selection shall be coordinated with the UH Landscape Project Manager.

6.8.2. Other Landscaping Recommendations

- Employ the published standard for the selection of plant material for use on campus.
- Encourage use of landscape buffer at the building perimeter
- Work within the current campus master planning.
- Preserve existing trees, particularly the remnants of the existing woods (post oaks).
- Replace any trees removed due to new construction or renovation projects. Replacement trees shall match or exceed caliper inch per caliper inch of trees removed during construction. If space to plant similarly calipered trees does not exist, (with the approval of the UH Landscape Project Manager) larger caliper trees may also be used or replacement trees may be located on alternate sites.
- Consider a University tree farm to ensure a reliable supply of trees for the Campus.

6.8.3. Prepared Soil Mix:

Soil mix for exterior planting beds shall be a weed free mix of 20% sharp sand, 40% composted pine bark or rice hulls, and 40% topsoil.

6.8.4. Mulch:

Mulch material for exterior planting beds shall be double shredded hardwood mulch.

6.8.5. Gravel: Gravel shall not be used in planting beds. DG may be used for paths or seating cutouts

6.8.6. Turf:

Turf shall be 100% Raleigh St. Augustine sod (*Stenotaphrum secundatum* “Raleigh”) for partial shade locations or Bermuda (*Cynodon dactylon*) for primarily sunny locations.

6.8.7. Staking and Guying Materials:

Stakes for bi-staking trees shall be 8-foot T-posts stakes.

Wire guys for tree support shall be pliable No. 10 gauge galvanized wire.

Hose for chafing guards shall be new or used two-ply fiber reinforced garden hose of not less than 3/4 inch diameter. One color shall be used throughout the job. *Alternate:* Metal T-Post may be used.

6.8.8. Root Stimulator

Green Light Root Stimulator and Starter Solution (5-20-10) or equal.

6.8.9. Planting Beds

Planting beds shall receive a minimum of four inches of prepared soil mixture, tilled thoroughly with existing soil until a homogenous mixture is achieved to a depth of six to eight inches. EPTAM pre-emergent herbicide shall be incorporated thoroughly at the rate of 20 lbs. per 1000 sq. ft.; and 13-13-13 fertilizer at the rate of 8 lbs. per 1000 sq. ft. into the top three inches of the prepared planting bed.

Prepared beds shall be mulched with two-inches of composted mulch.

6.9 IRRIGATION

6.9.1. PVC Pipe & Fittings

Pressure main line piping 6" and larger shall be Class 200 rubber gasket pipe and 4" and smaller shall be PVC Schedule 40 with solvent welded joints.

Pipe shall be made from an NSF approved Type I, Grade I, PVC compound conforming to ASTM resin specification D1785. All pipe must meet requirements as set forth in Federal Specification PS-22-70, with an appropriate standard dimension (S.D.R.) and be solvent-weld pipe.

6.9.1. Non-Pressure Lateral Line Piping:

Non-pressure buried lateral line piping shall be PVC class 200 with solvent-weld joints.

Pipe shall be made from NSF approved, Type I, Grade II PVC compound conforming to ASTM resin specification D1784.

PVC solvent-weld fittings shall be Schedule, 40, 1-2, II-I NSF approved conforming to ASTM test procedure D2466 for all PVC 4" and smaller.

Solvent cement and primer for PVC solvent-weld pipe and fittings shall be Christie's Red Hot Blue Glue, manufacturer.

Rubber Gasket Type AWWA C153 Ductile Iron Fitting shall be used for all PVC pipe 6" and larger under constant pressure

6.9.2. Brass Pipe and Fittings: not used

6.9.3. Galvanized Pipe Fittings: not used

6.9.4. Valves:

6.9.5.1 Gate valves 4" and smaller shall be 200 lb. WOG (water, oil, gas), bronze gate valve featuring screw-in bonnet, nonrising stem and solid wedge disc, threaded ends, and bronze handwheel. Manufacture by Nibco or approved equal.

6.9.5.2 Gate valves 6 inch and larger shall be cast or ductile iron.

6.9.5.3 Quick Coupling Valves shall have a bronze one-piece body designed for working pressure of 150 P.S.I. operable with quick coupler. Valves shall have swing joint and o-ring seals and be installed in valve boxes.

6.9.5.4 Backflow prevention units shall be of size and type indicated on the irrigation drawings. Install backflow prevention units in accordance with irrigation construction details.

6.9.5.5 Swing check valves 2" and smaller shall be 200 pound W.O.G. bronze construction with replaceable composition, neoprene or rubber disc and shall meet or exceed Federal Specification WW-V-51D, Class A, Type IV

6.9.5.6 Anti-drain check valves shall be of heavy duty virgin PVC construction with R.I.P. thread inlet and outlet. Internal parts shall be stainless steel and neoprene. Anti-drain valves shall be field adjustable against drawout from 5 to 40 feet of head. Anti-drain valves shall be similar to the Valcon "ADV" or approved equal.

6.9.6 Electrical Control Valves:

Provide and install one Rainbird control valve box for each electric control valve.

All electric control valves shall be of the same manufacturer and shall feature a manual flow adjustment.

6.9.7 Valve Boxes:

Use 10" x 10-1/4" round box for all gate valves 2 1/2" and smaller, quick couplers and for all wire field splices. Carson Industries #910-12B with black bolt down cover or approved equal. Extension sleeve shall be PVC-6" minimum size. Provide minimum 4" deep clean pea gravel in bottom of all valve boxes (valves to have minimum 2" clearance).

Use 9-1/2" x 16" x 11" rectangular box for all electrical control valves, and 3" and 4" gate valves, Carson Industries 1419-12B with black bolt down cover or approved equal. Provide minimum 4" deep clean pea gravel in bottom of all valve boxes (valves to have minimum 2" clearance).

6.9.8 Sprinkler Heads:

Refer to Master Specification Section 328400, Planting Irrigation.

All sprinkler heads shall be of the same size, manufacturer, model, and deliver the same rate of precipitation. Riser nipples for all sprinkler heads shall be the same size as the riser opening in the sprinkler body.

6.9.9 Automatic Controllers:

Refer to Master Specification Section 328400, Planting Irrigation.

Irrigation controllers shall have inline flow monitors compatible with controllers in use on campus.

Final location of automatic controllers shall be approved by the UH Landscape Project Manager.

6.9.10 Control Wiring:

Connections between the automatic controllers and the electric control valves shall be made with direct burial, insulated copper wire AWG-U.F. 600 volt. Wiring will be a two wire system compatible with

Baseline integrated system. Common wires shall be a different color wire for each automatic controller. In no case shall wire size be less than #14.

6.10 FURNISHINGS

6.10.1 General

Campus site furnishings vary in age, condition, style and material. Existing furnishings that are outdated, vandalized or deteriorated shall be replaced as needed with the style indicated in these guidelines until all site furnishings conform to the required standard.

Campus standard site furnishings shall be employed to ensure that all items are of the same family with regard to style, color, and material, and to create a uniformity of expression for exterior use areas of the campus. Ensure that all items placed on the grounds and in public areas of the campus have a purpose for their placement, and will serve in a convenient but unobtrusive manner.

6.10.2. Furnishing Specifications

6.10.2.1. Benches

Benches specified for new or replacement installations shall be the Austin bench with cantilevered mounting from Landscape Forms. (See **Figure 6.10.1**) The bench shall be permanently anchored to a concrete base, and placed in a landscape alcove or courtyard-type area adjacent to but off main walkways areas. (See **Figures 6.10.1a and b.**) Benches shall not be placed directly on high-traffic walkways and corridors.

Consideration shall be given for deviations from the norm for benches that are dedicated as memorials or given as gifts to the University.



**FIGURE 6.10.1
BENCHES**

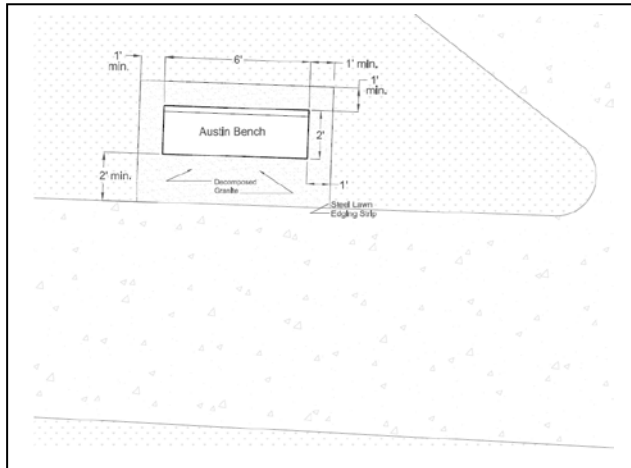

FIGURE 6.10.1a
BENCH ALCOVE

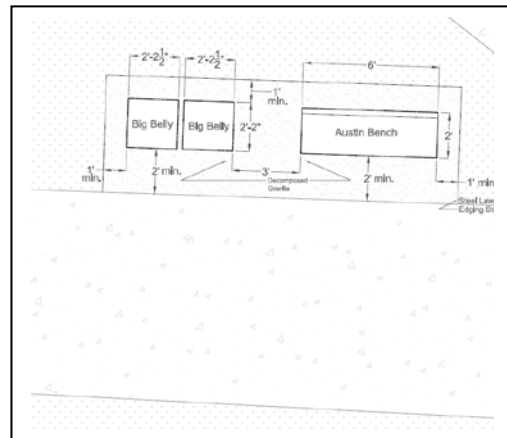

FIGURE 6.10.1b
BENCH/BIG BELLY ALCOVE



FIGURE 6.10.2
TABLES AND UMBRELLAS

6.10.2.2. Tables

Tables shall be Landscape Forms Carousel Table with black powdercoat finish, Equinox Umbrella and Catena solid table tops. (See **Figure 6.10.2.**)

In groupings of three or more tables, one table shall be wheelchair accessible.

6.10.2.3. Planters

Facilities Maintenance locates planters strategically on campus to control vehicular traffic. Requests for planters must be approved by UH Landscape Project Manager.

6.10.2.4. Trash Receptacles

Trash receptacles specified for new or replacement installations shall be Big Belly Solar Waste and Recycling Containers. Big Belly Containers shall be included in all capital improvement project budgets and site plans. Consult UH Project Manager for further information. (**Figure 6.10.3**)

6.10.2.5. Ash Urns

The University of Houston is a smoke free campus. Ash urns shall not be located on the campus grounds.



**FIGURE 6.10.3
BIG BELLY RUBBISH/RECYCLING CONTAINERS**

6.10.2.6. Bike Racks

Two styles of bike racks are allowed under these guidelines. The preferred style is the “ring style” (**Figure 6.10.4a**) in stainless steel or in a silver-colored powder-coated finish. The “ribbon style” bike rack (**Figure 6.10.4b**) (steel with a powder-coated finish) may also be used, especially in areas where higher concentrations of bikes are desired. Bike rack areas shall feature a decomposed granite surface; bike racks shall be permanently installed on a concrete base for durability.

Bike racks shall be placed in a location convenient to building entries, away from falling leaf and bird debris, but shall remain as visually unobtrusive as possible. Choice of location shall also take into account security camera coverage. Quantity of ring racks and length of ribbon racks shall be determined by usage requirements for each particular area.

**FIGURE 6.10.4a
RING STYLE BIKE RACK**

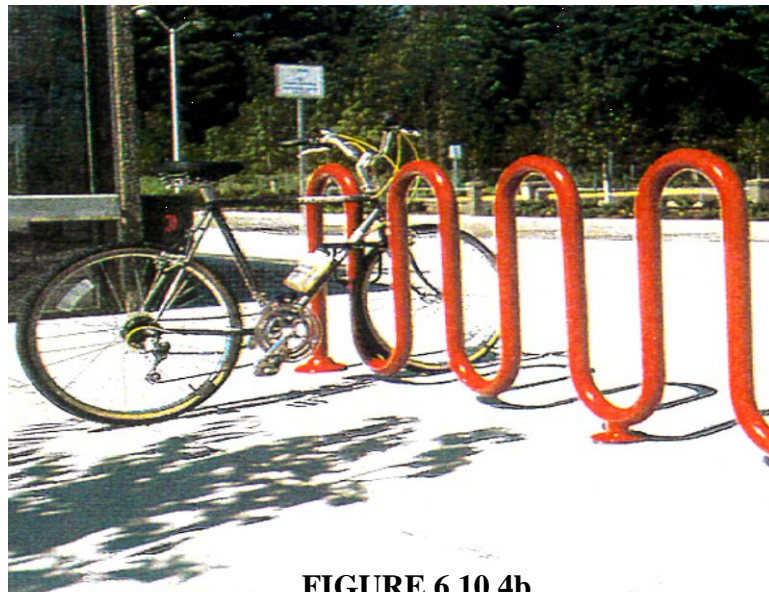

**FIGURE 6.10.4b
RIBBON STYLE BIKE RACK**

6.10.2.7. Bollards

Currently there exist many several types and sizes of bollards on campus used to control vehicular traffic on pedestrian walks and in parking lots. Design of bollards shall be considered on a project by project basis, as will the use of illuminated bollards to supplement pedestrian lighting. Existing bollards shall be replaced as the need arises and shall match surrounding bollards, if applicable. All new and replacement bollards must be removable, and should be cylindrical and feature sloped or crowned tops.

6.10.2.8. Sculpture

On construction projects in excess of \$1,000,000 involving construction of a new building or the addition of square footage to an existing building, the System-wide Art Acquisition Committee (SWAAC) shall provide art acquisition services for the administration.

Sculpture and memorial placement and choice shall consider the size, quality, and color of the piece for proper integration with the overall campus environment. Consideration shall be given for groupings of sculptural elements, to suggest a sculpture garden that is set within a well-landscaped context. Individual sculptures chosen for a group setting should not conflict with each other or create a non-cohesive grouping. Placement of sculpture on campus shall be coordinated with the sculptor, if possible, and the System-wide Art Acquisition Committee. (See Figure 6.10.5 for examples.)



FIGURE 6.10.5
CAMPUS SCULPTURES

6.11 LIGHTING

6.11.1 General Guideline

Light fixtures shall be chosen for durability, ease of use and maintenance, security, and aesthetic design. Lighting elements shall be exclusively Metal Halide for consistent light color and non-glare properties.

Walkway, parking lot, and roadway lighting shall be from overhead, pole-mounted sources. High wattage, low or wall-mounted spotlights that produce glare and create dark shadows shall not be used.

Contractor is cautioned to verify the voltage in use in the area of campus in which new or replacement pedestrian lighting will be installed.

6.11.2. Street and Parking Lights

Light fixtures for new or replacement installations shall be either a single head or double head canister style cylinder with a Metal Halide light element. The color of the pole, pedestal base and top shall be a black powder coat finish. Base mounting details for installation on lawn or planting areas shall be consistent throughout campus and shall be Sonotube formed concrete foundation exposed 6 inches above the finish grade, with the pedestal cap on top, concealing the pole mounting bolts. Installation on paved surfaces shall be nearly identical, with the pedestal cap resting flush with the pavement and with no foundation exposed.

Lighting location shall consider safety and adequate illumination of the surrounding area. Design consideration should also be given of the fixtures as part of the overall landscape: linear alignment, progression, etc. (See Figure 6.11.2)

Refer to **Section 9.9** of the Campus Guidelines and Standards for additional parking lot lighting requirements.

6.11.3 Pedestrian Lights and Light Poles

Light fixtures for new or replacement installations shall be the Saturn Cutoff LED, a single mount luminaire with die-cast aluminum cover. The fixtures should be mounted on a 10' round tapered aluminum pole, with round tapered one piece base cover. The color of the pole and base cover shall be anodized dark bronze. Base mounting details for installation on lawn or planting areas shall be consistent throughout campus and shall be 14" diameter Sonotube formed concrete foundation exposed 5 inches above the finish grade, with slight convex top to shed water. Contractor shall install four leveling nuts between concrete base and pole mounting plate. Hinge location shall not impede pedestrian or vehicular traffic when in down position.

Lighting location shall consider safety, adequate illumination of the surrounding area. Design consideration should also be given of the fixtures as part of the overall landscape: linear alignment, progression, etc. (See Figure 6.11.1)

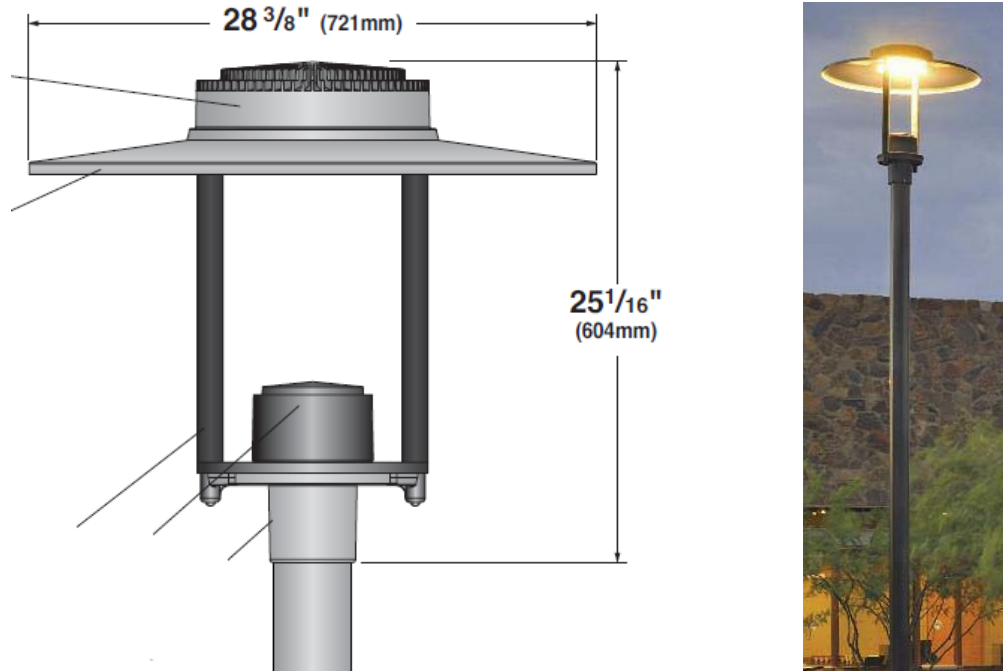
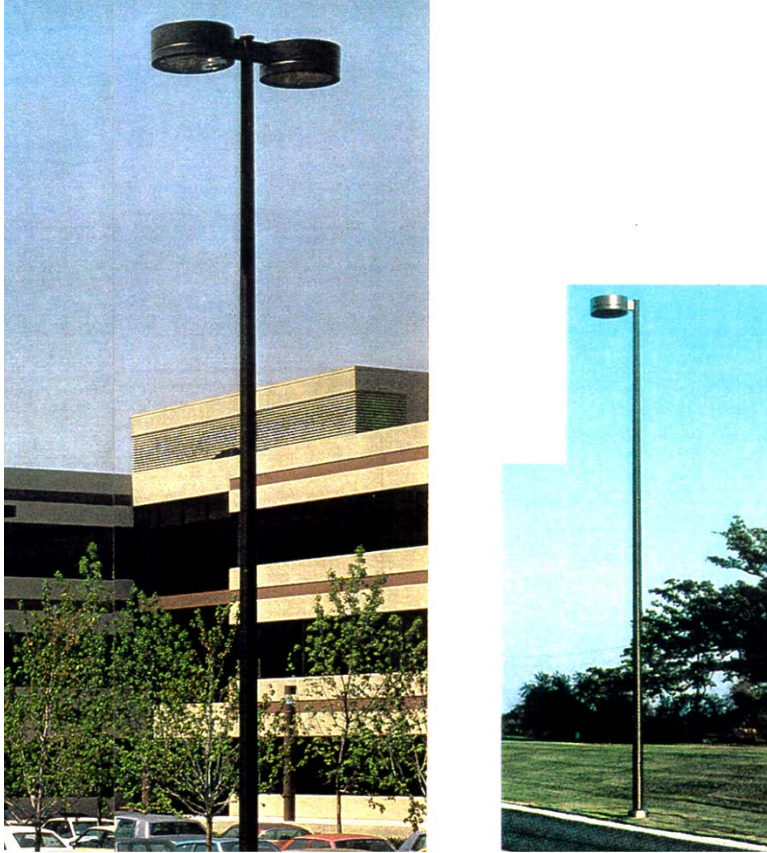

FIGURE 6.11.1
PEDESTRIAN LIGHTS

6.11.4 Lighting Intensities

Refer to **Section 11.2** of the Campus Guidelines and Standards for required light intensity levels.



**FIGURE 6.11.2
STREET AND PARKING LIGHTS**

6.12 LANDSCAPE PLANS

6.12.1. Requirements

Landscape plans are required for all new major campus building or landscape projects that require site development or modification. Plans must be drawn to scale and identify and show the locations of existing and proposed property lines, easements, roadways, sidewalks, lights, trees, shrubs, groundcovers and other plant materials, natural features, all other landscape elements and planting and construction details. A plant schedule shall be provided which includes the type, installation size, number and placement of materials. Plants are to be identified by both their botanical and common names. Trees that have been designated as to be preserved or relocated by the University shall be identified along with the method of irrigation and protection and the proposed new location.

Landscape plans shall be submitted to FPC for internal distribution and review by Facilities Planning and Construction and by Facilities Maintenance (including the UH Landscape Project Manager). It is the responsibility of FPC to distribute the documents to the appropriate department heads and other appropriate University personnel for review and to verify requirements. FPC is responsible for coordination of all UH comments and requirements. The plans shall not be issued for pricing or construction until the consultant has received notification from the FPC to proceed.